

# Engineer's Mini-Notebook

Sensor  
Projects

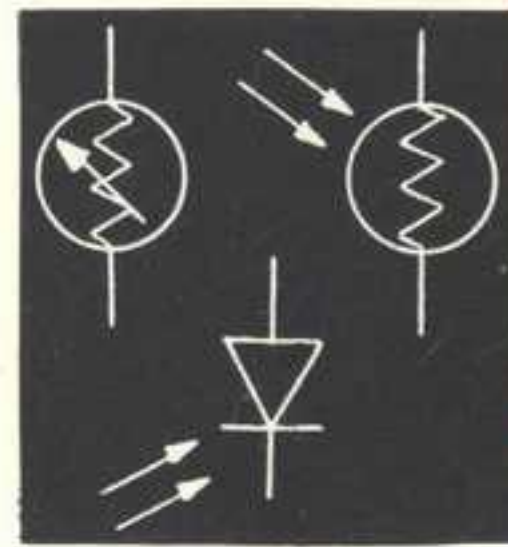
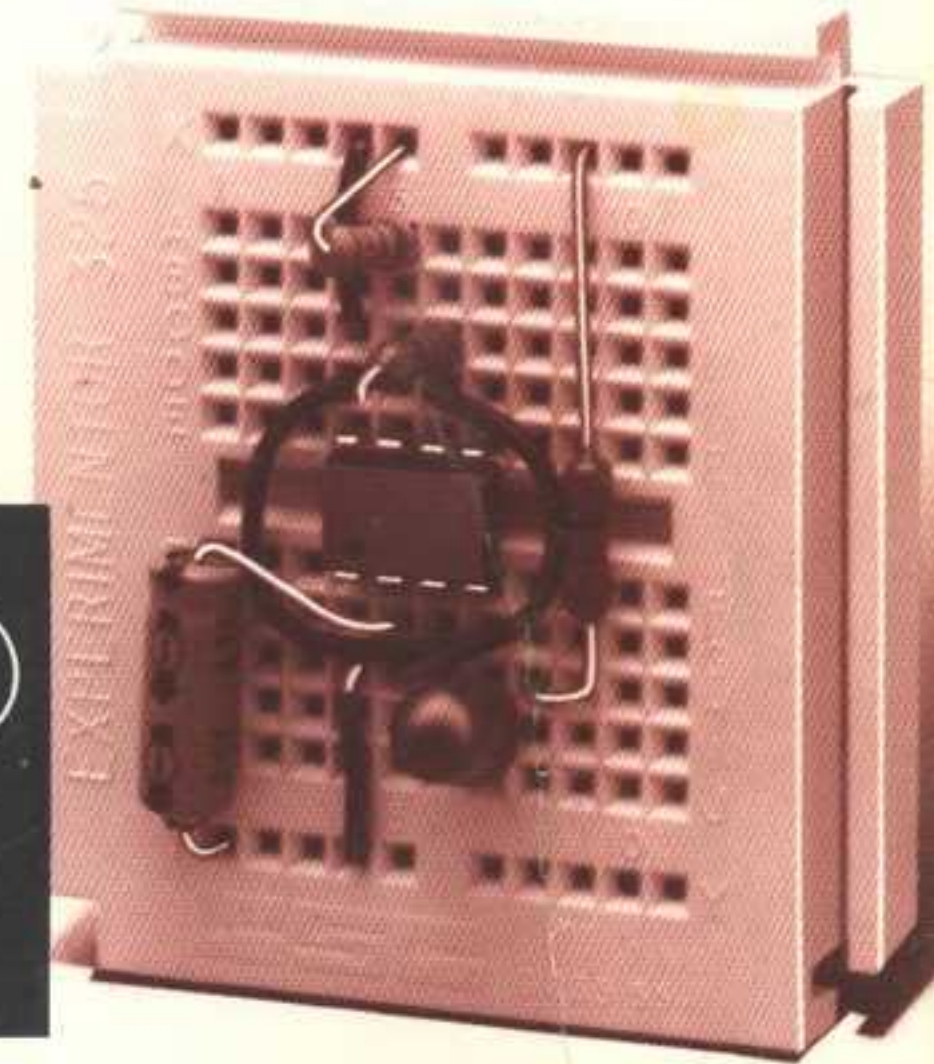

Forrest M. Mims III

**Radio Shack**

A Division of Tandy Corporation  
Fort Worth, TX 76102

PRINTED IN U.S.A.

62-5026



0 40293 11708 5

ENGINEER'S  
MINI-NOTEBOOK  
SENSOR PROJECTS

BY  
FORREST M. MIMS III

FIRST EDITION  
FIRST PRINTING

A SILICONCEPTS™ BOOK

COPYRIGHT © 1996 BY FORREST M. MIMS III  
ALL RIGHTS RESERVED

PRINTED IN THE UNITED STATES OF AMERICA

THIS BOOK INCLUDES STANDARD APPLICATION CIRCUITS AND CIRCUITS DESIGNED BY THE AUTHOR. EACH CIRCUIT WAS ASSEMBLED AND TESTED BY THE AUTHOR AS THE BOOK WAS DEVELOPED. AFTER THE BOOK WAS COMPLETED, THE AUTHOR REASSEMBLED EACH CIRCUIT TO CHECK FOR ERRORS. WHILE REASONABLE CARE WAS EXERCISED IN THE PREPARATION OF THIS BOOK, VARIATIONS IN COMPONENT TOLERANCES AND CONSTRUCTION METHODS MAY CAUSE THE RESULTS YOU OBTAIN TO DIFFER FROM THOSE GIVEN HERE. THEREFORE THE AUTHOR AND RADIO SHACK ASSUME NO RESPONSIBILITY FOR THE SUITABILITY OF THIS BOOK'S CONTENTS FOR ANY APPLICATION. SINCE WE HAVE NO CONTROL OVER THE USE TO WHICH THE INFORMATION IN THIS BOOK IS PUT, WE ASSUME NO LIABILITY FOR ANY DAMAGES RESULTING FROM ITS USE. OF COURSE IT IS YOUR RESPONSIBILITY TO DETERMINE IF COMMERCIAL USE, SALE OR MANUFACTURE OF ANY DEVICE THAT INCORPORATES INFORMATION IN THIS BOOK INFRINGES ANY PATENTS, COPYRIGHTS OR OTHER RIGHTS.

DUE TO THE MANY INQUIRIES RECEIVED BY RADIO SHACK AND THE AUTHOR, IT IS NOT POSSIBLE TO PROVIDE PERSONAL RESPONSES TO REQUESTS FOR ADDITIONAL INFORMATION (CUSTOM CIRCUIT DESIGN, TECHNICAL ADVICE, TROUBLESHOOTING ADVICE, ETC.). IF YOU WISH TO LEARN MORE ABOUT ELECTRONICS, SEE OTHER BOOKS IN THIS SERIES AND RADIO SHACK'S "GETTING STARTED IN ELECTRONICS." ALSO, READ MAGAZINES LIKE POPULAR ELECTRONICS.

# CONTENTS

INTRODUCTION	5
ELECTRONIC SENSORS	6
GO-NOGO SENSORS	6
ANALOG SENSORS	7
BASIC SENSOR CIRCUITS	8
SENSORS AND COMPUTERS	9
TOUCH SWITCHES	10
MULTI-LAYER SWITCH	10
TACTILE FEEDBACK SWITCH	10
WHISKER-STYLE LEVER SWITCH	11
PUFF SWITCH	12
PAPER CLIP SWITCH	13
PHONE PLUG SWITCH	13
TILT SWITCH	13
MUSIC WIRE VIBRATION SENSOR	14
PIEZOELECTRIC VIBRATION SENSOR	15
PENDULUM SWITCH	16
PENDULUM QUADRANT SWITCH	17
SWITCH-TYPE ALARM SYSTEMS	18
OPEN-CIRCUIT ALARMS	18-19
CLOSED-CIRCUIT ALARM	19
INTELLIGENT SECURITY ALARM	20-21
FIRE OR WATER SENSOR	22
PULL SWITCH	23
	3

VOLTAGE SENSORS	24-25
ANALOG PRESSURE SENSOR	26
PRESSURE-TO-VOLTAGE SENSOR	27
STRAIN SENSORS	28
STRAIN SENSOR APPLICATIONS	29
STRAIN SENSOR DESIGNS	29
STRAIN SENSOR RELAY	30
STRAIN SENSOR TONE GENERATOR	30
STRAIN SENSOR AMPLIFIER	31
MAGNETIC FIELD SENSOR	32
MAGNETIC FIELD SWITCH	33
MAGNETIC FIELD AMPLIFIER	33
VIDEO MONITOR SENSORS	34
VIDEO MONITOR TONE GENERATOR	35
VIDEO MONITOR RELAY CIRCUITS	36-37
VIDEO MONITOR SENSOR PROGRAMS	38-39
LIGHTNING SENSOR	40-41
INFRARED SENSOR	42
INFRARED SWITCH	42
INFRARED AMPLIFIER	43
POLARIZED LIGHT	44
POLARIZED LIGHT SENSOR	45
INTEGRATED LIGHT SENSORS	46
LIGHT-TO-TONE SENSOR	46
IR REMOTE CONTROL SENSOR	47
LIGHT ACTIVATED RELAY	47
OPTICAL LEVEL SENSORS	48
VARIABLE TONE LEVEL SENSOR	48
SWITCHED TONE LEVEL SENSOR	48

## INTRODUCTION

ONE OF THE MOST IMPORTANT APPLICATIONS OF ELECTRONICS IS THE USE OF SENSORS TO DETECT AND RESPOND TO EXTERNAL STIMULI SUCH AS TOUCH, PRESSURE, WATER, HEAT, LIGHT, MAGNETIC FIELDS AND SO FORTH. THESE ARE AMONG THE SENSOR APPLICATIONS IN THIS MINI-NOTEBOOK. YOU CAN MAKE SOME SENSORS, AND MANY SENSORS AND SENSING SYSTEMS ARE AVAILABLE FROM RADIO SHACK STORES AND RADIO SHACK UNLIMITED.

## DESIGN TIPS

1. THE UBIQUITOUS 741 OPERATIONAL AMPLIFIER IS USED IN THIS MINI-NOTEBOOK. BUT YOU CAN SUBSTITUTE NEWER OP AMPS IF YOU DO NOT EXCEED THEIR MAXIMUM POWER SUPPLY VOLTAGE. BE SURE TO CHECK THE PIN OUTLINE.
2. UNLESS OTHERWISE SPECIFIED, USE 1/4 OR 1/2 WATT RESISTORS AND CAPACITORS RATED FOR AT LEAST THE POWER SUPPLY VOLTAGE. IF EXACT VALUES ARE UNAVAILABLE, YOU CAN USUALLY SUBSTITUTE VALUES WITHIN 10 TO 20% OF THE SPECIFIED VALUE.
3. ALWAYS BUILD A TEST VERSION OF A CIRCUIT ON A SOLDERLESS BREADBOARD BEFORE MAKING A PERMANENT VERSION. THIS WILL ALLOW YOU TO MAKE MODIFICATIONS TO THE CIRCUIT.

## SAFETY FIRST

1. POWER SENSOR CIRCUITS WITH BATTERIES.
2. DO-IT-YOURSELF SENSOR CIRCUITS ARE NOT APPROPRIATE FOR MEDICAL APPLICATIONS OR WHEN HUMAN LIFE OR SAFETY IS AT RISK.

## ELECTRONIC SENSORS

AN ELECTRONIC SENSOR RESPONDS TO AN EXTERNAL STIMULUS SUCH AS LIGHT, SOUND, PRESSURE, VIBRATION OR TEMPERATURE. MOST SENSORS CAN BE PLACED IN ONE OF TWO CATEGORIES: SIMPLE GO-NO GO SENSORS THAT ACT MUCH LIKE AN ON-OFF SWITCH AND ANALOG SENSORS WHOSE OUTPUT IS PROPORTIONAL TO THE STIMULUS.

### GO-NO GO SENSORS

GO-NO GO SENSORS ARE ALSO KNOWN AS ON-OFF, YES-NO OR BINARY SENSORS. SOME ARE SIMPLE MECHANICAL DEVICES SUCH AS MAGNETIC PROXIMITY SWITCHES AND VIBRATION SENSORS LIKE THOSE USED IN VARIOUS SECURITY SYSTEMS.

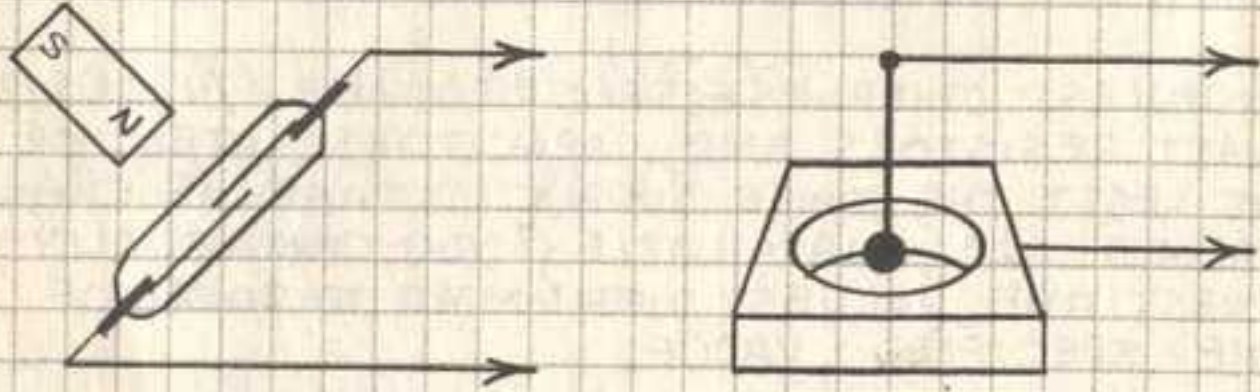

MAGNETIC REED SWITCH  
(MAGNET SENSOR)

PENDULUM SWITCH  
(VIBRATION SENSOR)

SOME GO-NO GO SENSORS INCLUDE AN ANALOG SENSOR AND A CIRCUIT THAT SWITCHES ON (OR OFF) WHEN THE AMPLITUDE OF WHAT IS BEING SENSED EXCEEDS (OR FALLS BELOW) A CERTAIN LEVEL. OFTEN THE POINT AT WHICH THE CIRCUIT SWITCHES CAN BE ADJUSTED BY ADDING OR CHANGING THE VALUE OF AN EXTERNAL RESISTOR OR BY A DIGITAL SWITCH ARRAY.

## ANALOG SENSORS

MANY KINDS OF ANALOG SENSORS ARE READILY AVAILABLE. SOME OF THE MOST COMMON ARE DESCRIBED HERE.

### PHOTORESISTOR

LIGHT-SENSITIVE RESISTOR WHOSE RESISTANCE CHANGES WITH LIGHT.



### PHOTODIODE

LIGHT-SENSITIVE DIODE WHICH PRODUCES A CURRENT IN RESPONSE TO LIGHT.



### THERMISTOR

TEMPERATURE-SENSITIVE RESISTOR WHOSE RESISTANCE CHANGES WITH TEMPERATURE.



### MICROPHONE

SOUND-SENSITIVE SENSOR WHICH PRODUCES A VOLTAGE OR CHANGES A CAPACITANCE AS THE SOUND LEVEL CHANGES.



### PIEZOELECTRIC

VARIOUS CRYSTALS OR CERAMICS WHICH PRODUCE A VOLTAGE WHEN BENT, VIBRATED OR SUBJECTED TO MECHANICAL SHOCK.



# BASIC SENSOR CIRCUITS

ELECTRONIC SENSORS REQUIRE A DEVICE THAT INDICATES WHEN SOMETHING HAS BEEN SENSED. THE INDICATOR FOR A SIMPLE GO-NO GO SENSOR SUCH AS A MAGNET SWITCH CAN BE A LAMP, LED OR BUZZER.

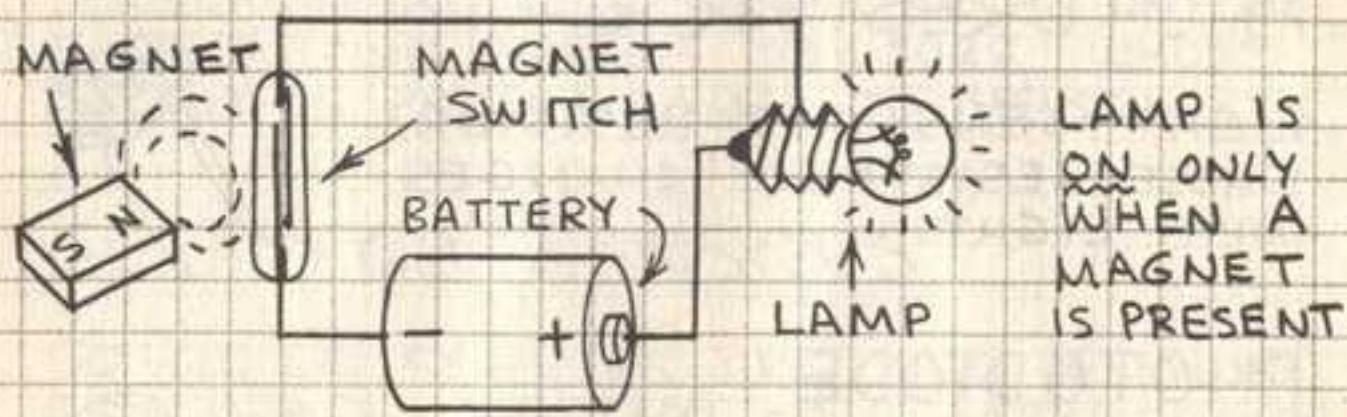

THE OUTPUT DEVICE FOR AN ANALOG SENSOR CAN BE AN ANALOG OR DIGITAL METER, AN OSCILLOSCOPE OR A COMPUTER.

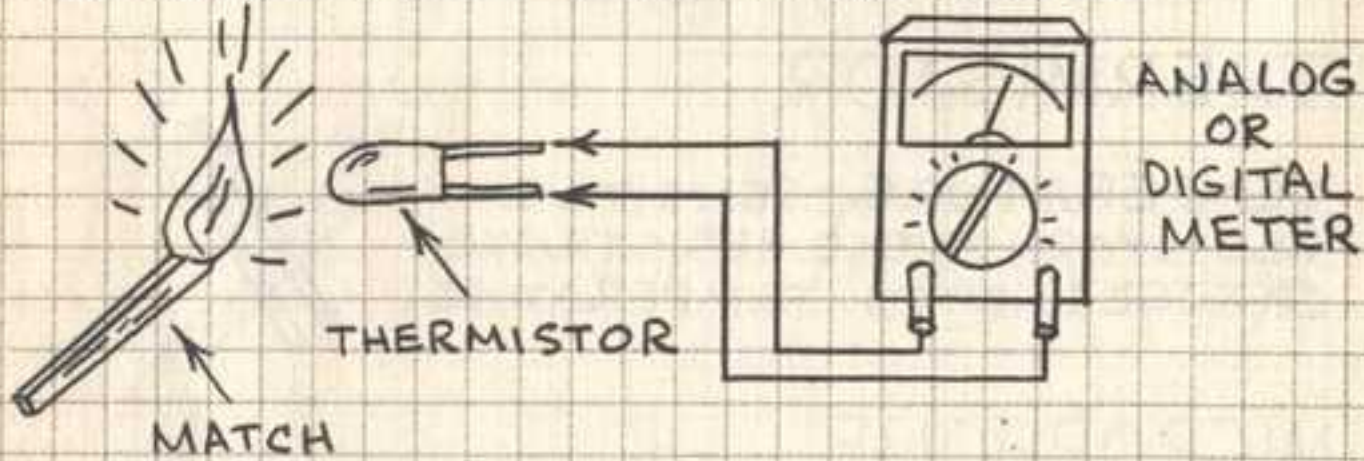

MANY ANALOG SENSORS REQUIRE A CIRCUIT TO PREPARE THE SIGNAL FOR AN OUTPUT INDICATOR. AN ESPECIALLY USEFUL CIRCUIT IS THE OPERATIONAL AMPLIFIER (OP AMP). THE OP AMP CAN TRANSFORM THE TINY CURRENT FROM A PHOTODIODE INTO A VOLTAGE THAT IS EASILY INDICATED BY A METER.

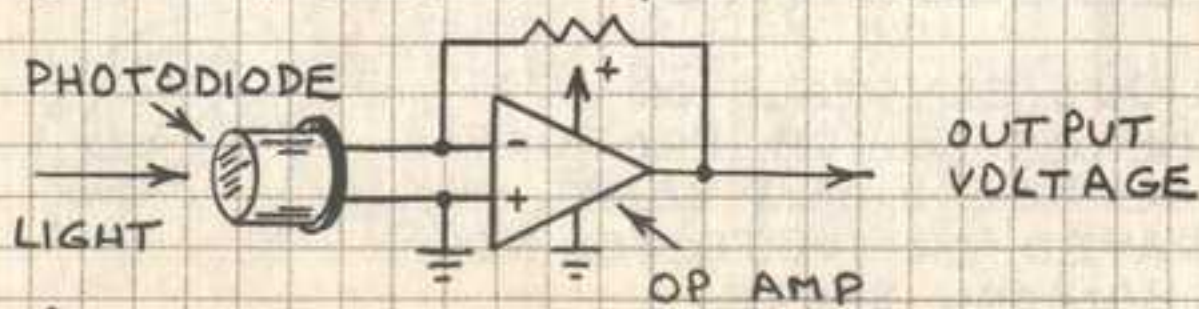

# SENSORS AND COMPUTERS

GO-NO GO SENSORS CAN BE EASILY CONNECTED TO COMPUTERS AND DIGITAL CIRCUITS.

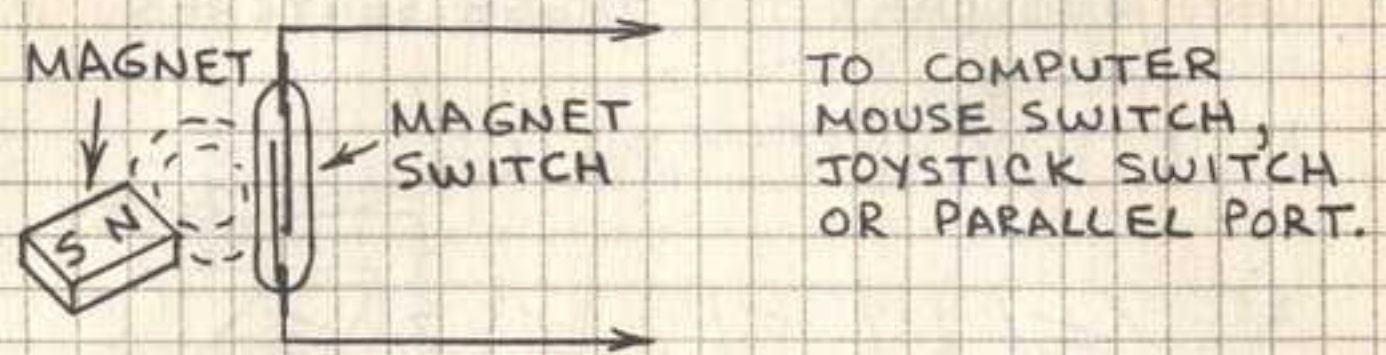

ANALOG SENSORS REQUIRE A CIRCUIT THAT TRANSFORMS THE SIGNAL FROM THE SENSOR INTO DIGITAL FORM THAT A COMPUTER CAN UNDERSTAND. ONE APPROACH IS TO CHANGE THE SIGNAL INTO A STRING OF PULSES WHOSE FREQUENCY IS PROPORTIONAL TO THE AMPLITUDE OF THE SIGNAL. THE COMPUTER IS THEN PROGRAMMED TO COUNT THE PULSES DURING A GIVEN TIME.

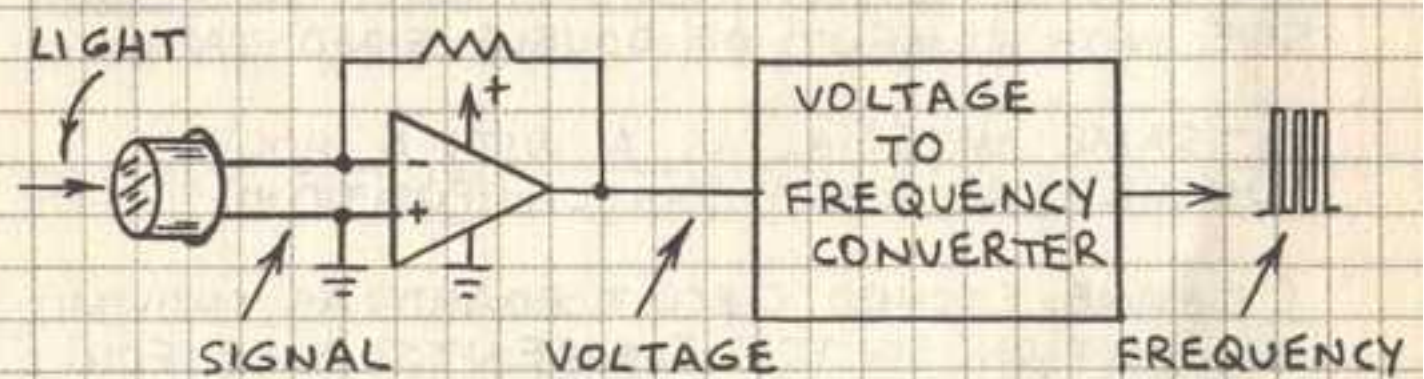

AN ANALOG-TO-DIGITAL CONVERTER (A/D CONVERTER) CHANGES A SIGNAL FROM A SENSOR INTO A BINARY NUMBER PROPORTIONAL TO THE AMPLITUDE OF THE SIGNAL.

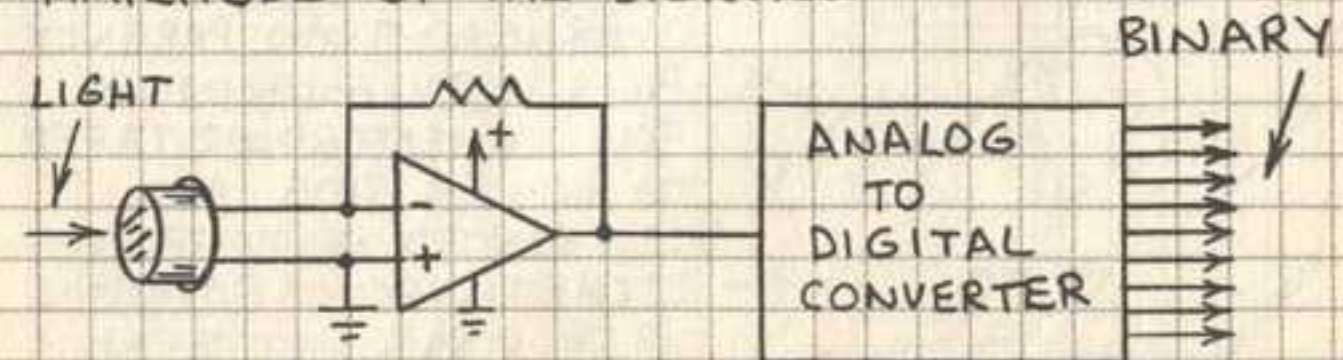

## TOUCH SWITCHES

USE A STANDARD SWITCH WHEN POSSIBLE. FOR SPECIAL APPLICATIONS OR FOR ULTRA-THIN SWITCHES TRY THESE SWITCHES.

### MULTI-LAYER SWITCH

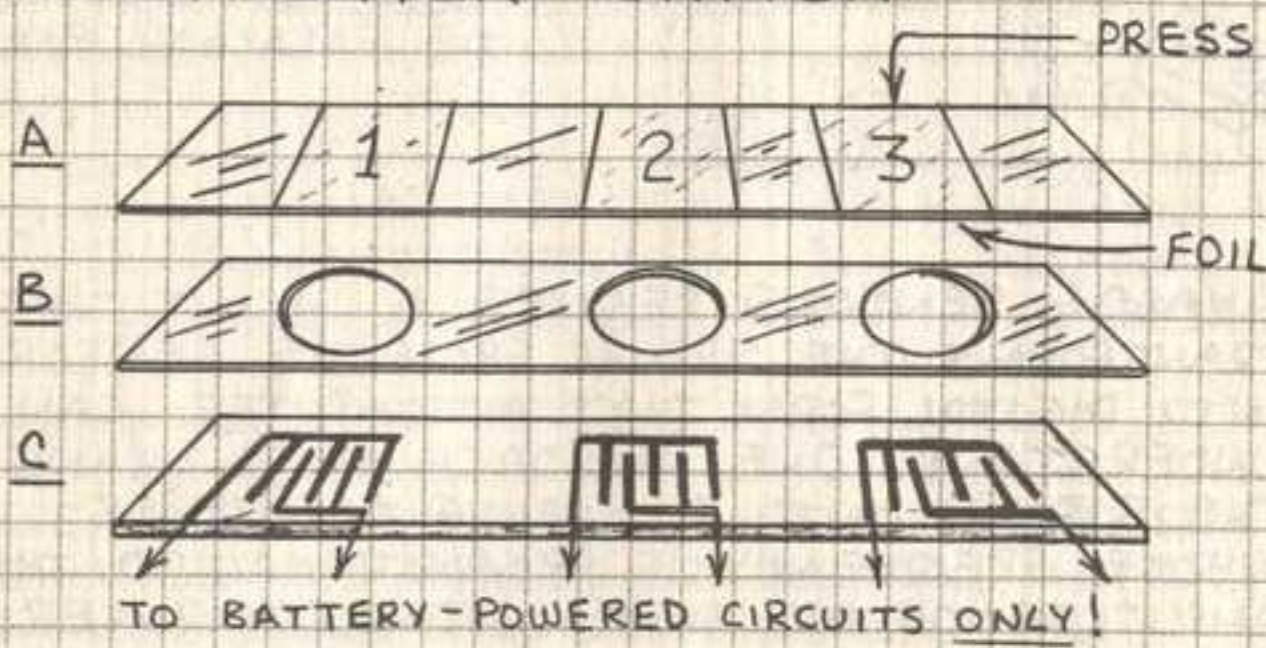

**A** - OVERHEAD TRANSPARENCY FILM WITH ALUMINUM FOIL SQUARES ATTACHED TO LOWER SIDE WITH CEMENT OR DOUBLE-SIDED TAPE.

**B** - SAME MATERIAL AS A WITH A HOLE PUNCHED AT EACH SWITCH POSITION.

**C** - MAKE ETCHED CIRCUIT BOARD AS SHOWN OR POSITION SWITCH ELEMENTS OVER FOIL PATTERN IN A PRE-ETCHED BOARD.

### TACTILE FEEDBACK SWITCH

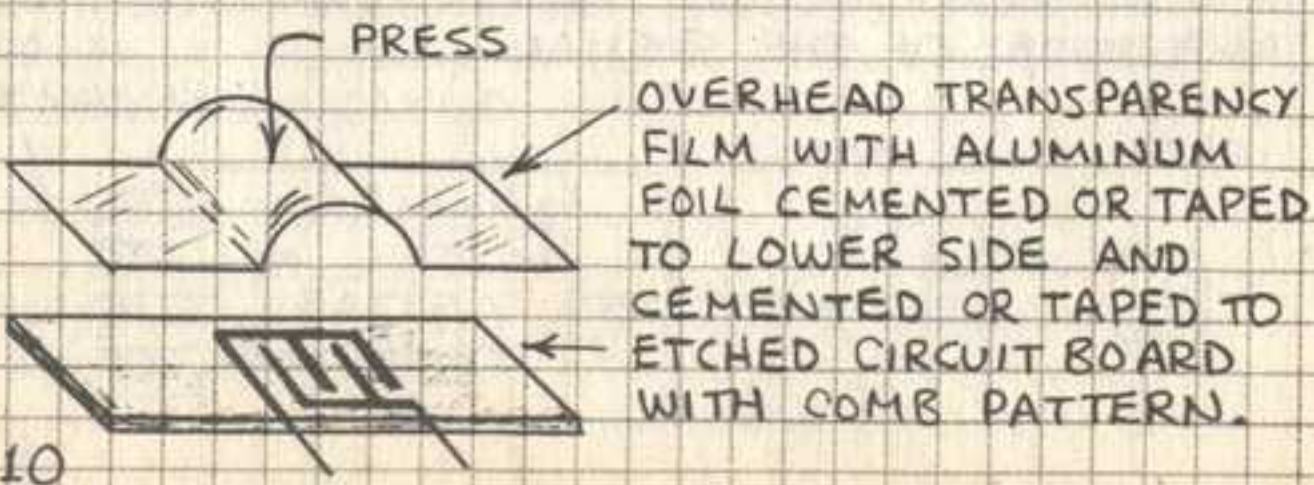

10

## WHISKER-STYLE LEVER SWITCH

ATTACH STIFF PLASTIC ROD OR MUSIC WIRE TO MOVABLE LEVER ON A LEVER SWITCH TO MAKE A WHISKER SWITCH.

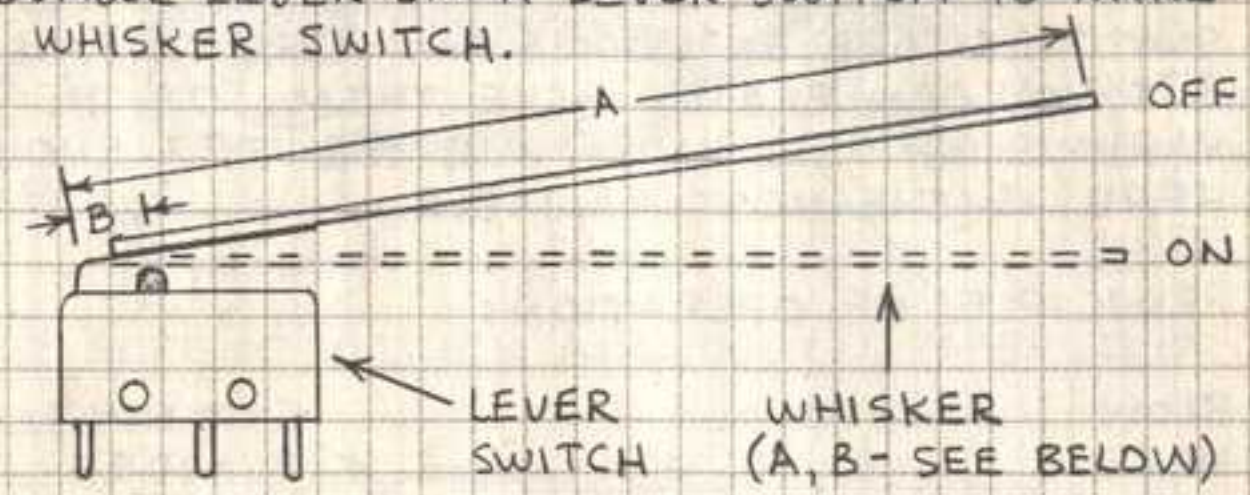

WHISKER SWITCH APPLICATIONS:

ROBOTICS - SENSE PRESENCE OF OBJECTS.

INDUSTRY - HANG WHISKER OVER CONVEYOR BELT TO DETECT CARTONS AND OBJECTS PASSING BY.

RESEARCH - DRAG WHISKER OVER SOIL OR GRASS TO DETECT AND COUNT ROCKS AND PLANTS.

## PHYSICS OF LEVER SWITCHES

THE WHISKER SWITCH IS A SECOND CLASS LEVER.

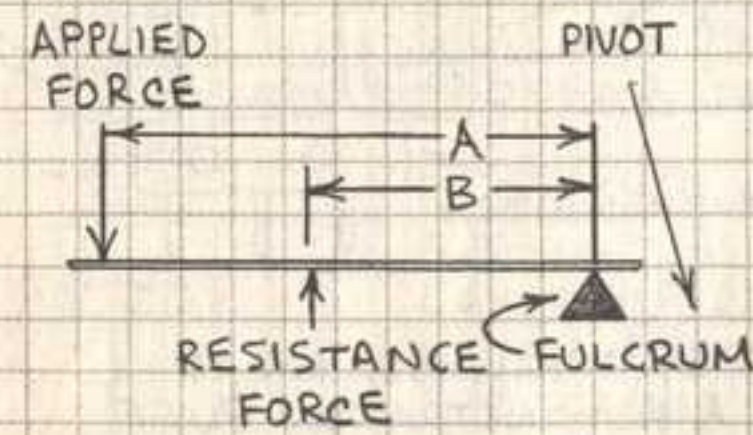

FOR AN IDEAL LEVER  
 $\text{APPLIED FORCE} \times A =$   
 $\text{RESISTANCE FORCE} \times B$

RESULTS BELOW FROM POSTAGE SCALE AND RULER TAPED TO SWITCH LEVER. RULER WAS PRESSED AGAINST SCALE PLATFORM.

A (cm)	FORCE (grams)
2	49.6
5	22.7
10	11.3
15	7.1

1 OUNCE = 28.35 GRAMS

11

## PUFF SWITCH

A PUFF SWITCH IS CLOSED BY AIR PRESSURE OR SIMPLY BY BLOWING INTO A TUBE. PUFF SWITCHES ARE EXPENSIVE AND HARD TO FIND, BUT YOU CAN EASILY MAKE THEM. OF THE VARIOUS KINDS I HAVE MADE THE TYPE SHOWN HERE IS THE MOST RELIABLE.

PRINCIPLE OF OPERATION:

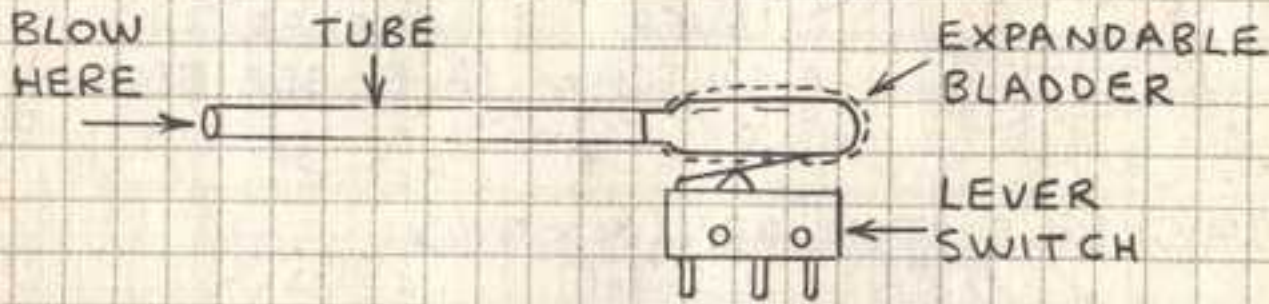

MOISTURE IN YOUR BREATH WILL CONDENSE INSIDE THE TUBE AND CAUSE A SWITCH MECHANISM TO CORRODE OR STICK. THIS METHOD KEEPS MOISTURE AWAY FROM THE SWITCH. BELOW IS A DEMONSTRATION SWITCH WHICH CAN FORM THE BASIS OF A WORKING PUFF SWITCH.

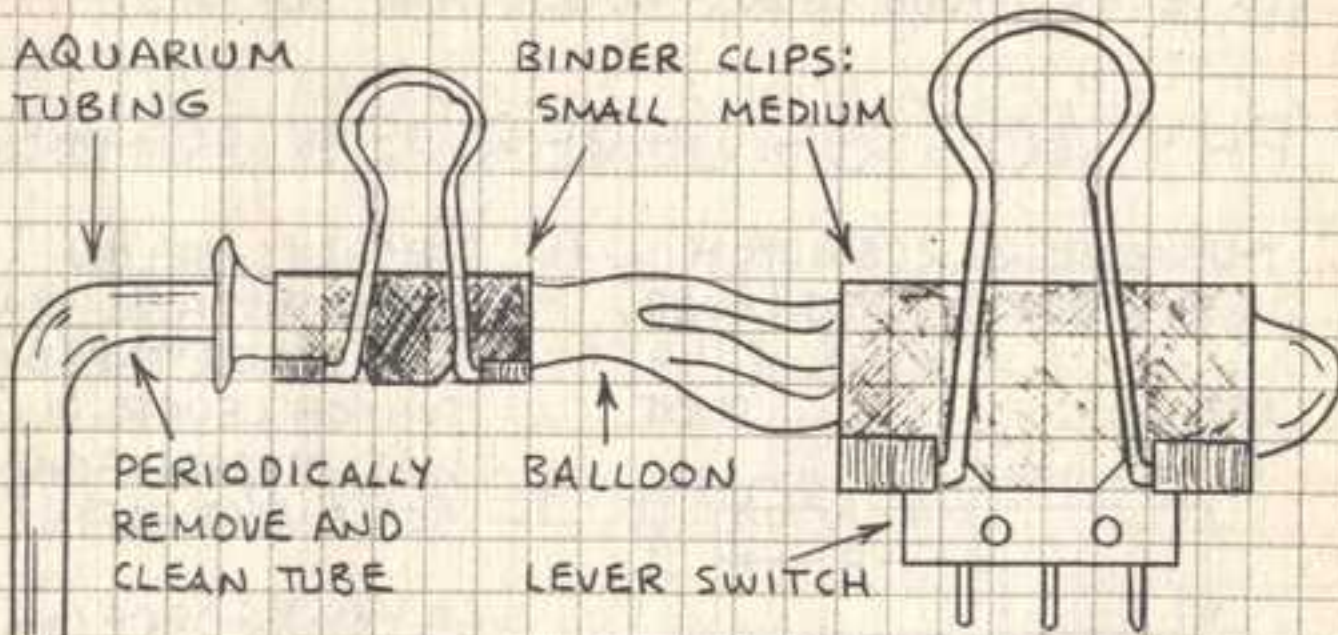

THIS ARRANGEMENT ALLOWS YOU TO QUICKLY MAKE A DEMONSTRATION PUFF SWITCH. FOR PERMANENT USE INSTALL IN A PLASTIC BOX CONNECTED TO THE OUTSIDE WORLD WITH A BRASS AQUARIUM TUBE JUNCTION AND SWITCH WIRES.

12

## PAPER CLIP SWITCH

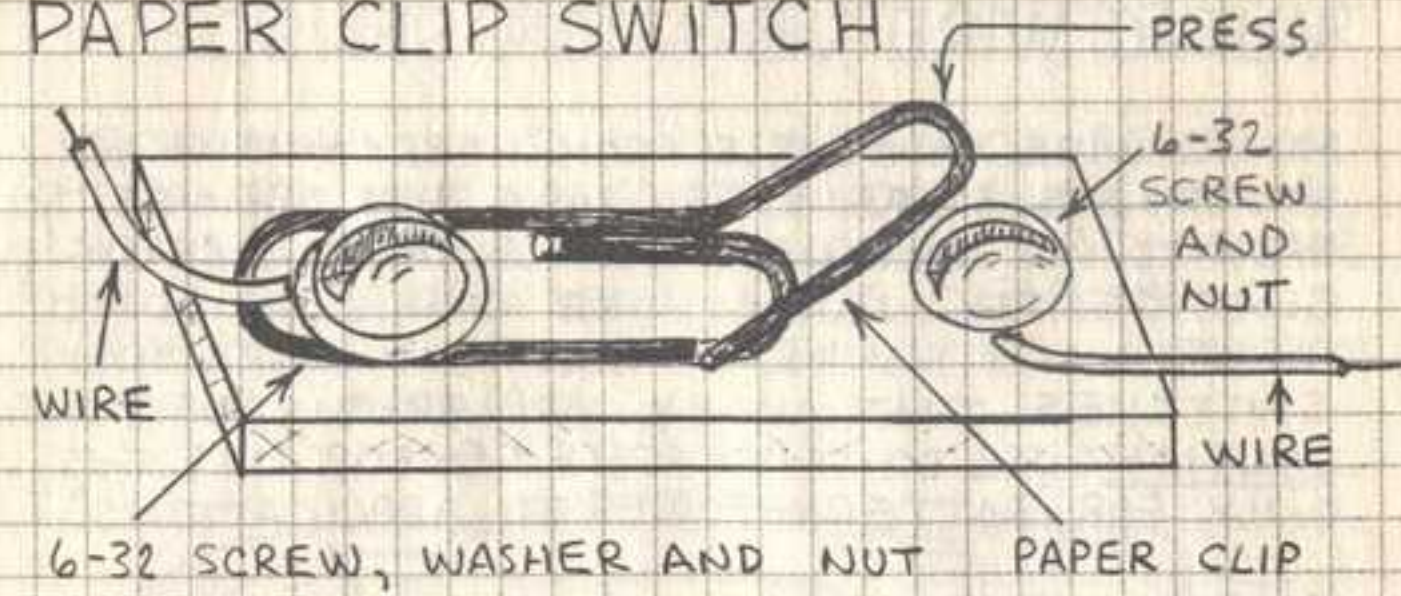

## PHONE PLUG SWITCH



INSERT PLUG IN JACK TO CLOSE SWITCH. PULL PLUG FROM JACK TO OPEN SWITCH.

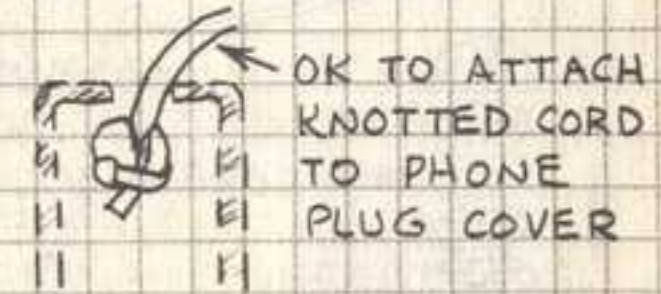

## TILT SWITCH

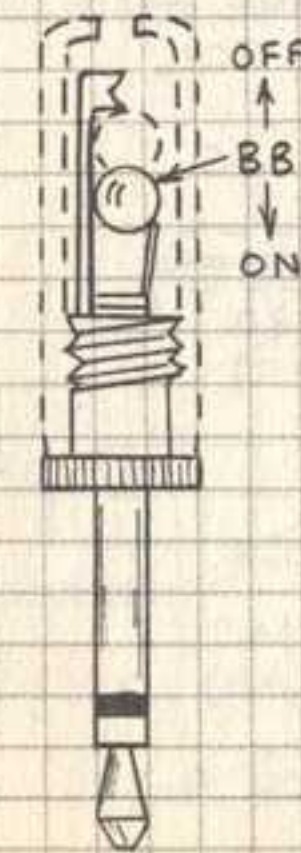

THIS SWITCH CLOSES WHEN A STEEL AIR GUN SHOT (BB) ROLLS AGAINST THE TERMINALS IN A 1/8-INCH PHONE PLUG. INVERT PHONE PLUG TO OPEN SWITCH.

PROTOTYPE USED ZINC-PLATED, 4.5 mm BB COATED WITH A LAYER OF PROTECTIVE LACQUER WHICH DOES NOT CONDUCT ELECTRICITY. THEREFORE I PLACED BB IN SMALL HOLE BORED IN WOOD, MELTED SOLDER OVER IT AND PUSHED BB FROM HOLE WITH SOLDERING IRON. (BB WAS HOT!)

13



## MUSIC WIRE VIBRATION SENSOR

MUSIC WIRE (AVAILABLE FROM HOBBY AND CRAFT STORES) IS STIFF STEEL WIRE THAT SPRINGS BACK TO ITS ORIGINAL POSITION AFTER BEING BENT GENTLY. MUSIC WIRE CAN BE USED TO MAKE MANY KINDS OF TILT AND VIBRATION SWITCHES THAT WORK IN VARIOUS POSITIONS. **CAUTION:** USE DO-IT-YOURSELF SENSOR LIKE THIS ONLY FOR BATTERY-POWERED APPLICATIONS!

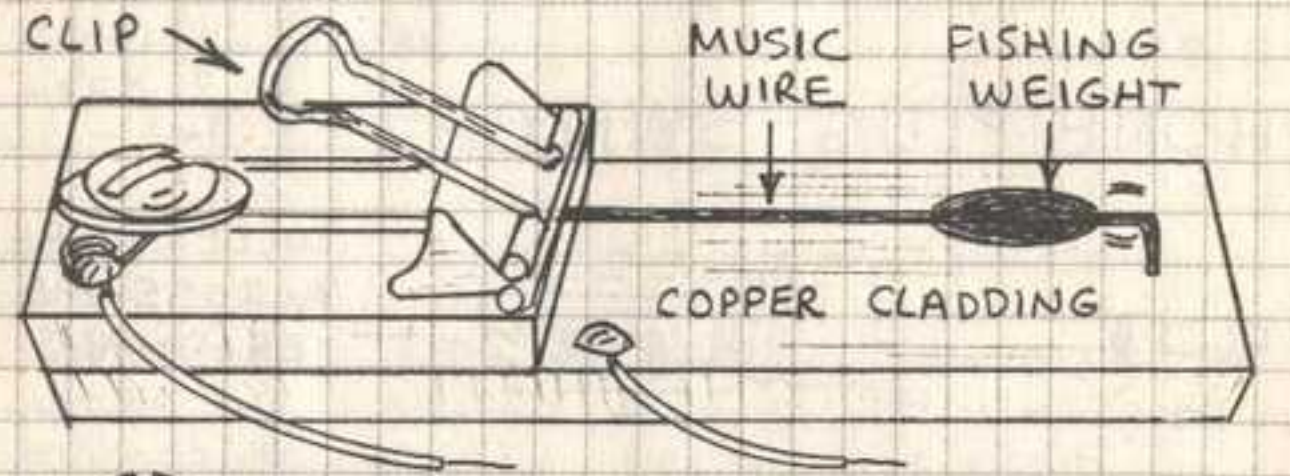

TO BUZZER, LIGHT OR ALARM

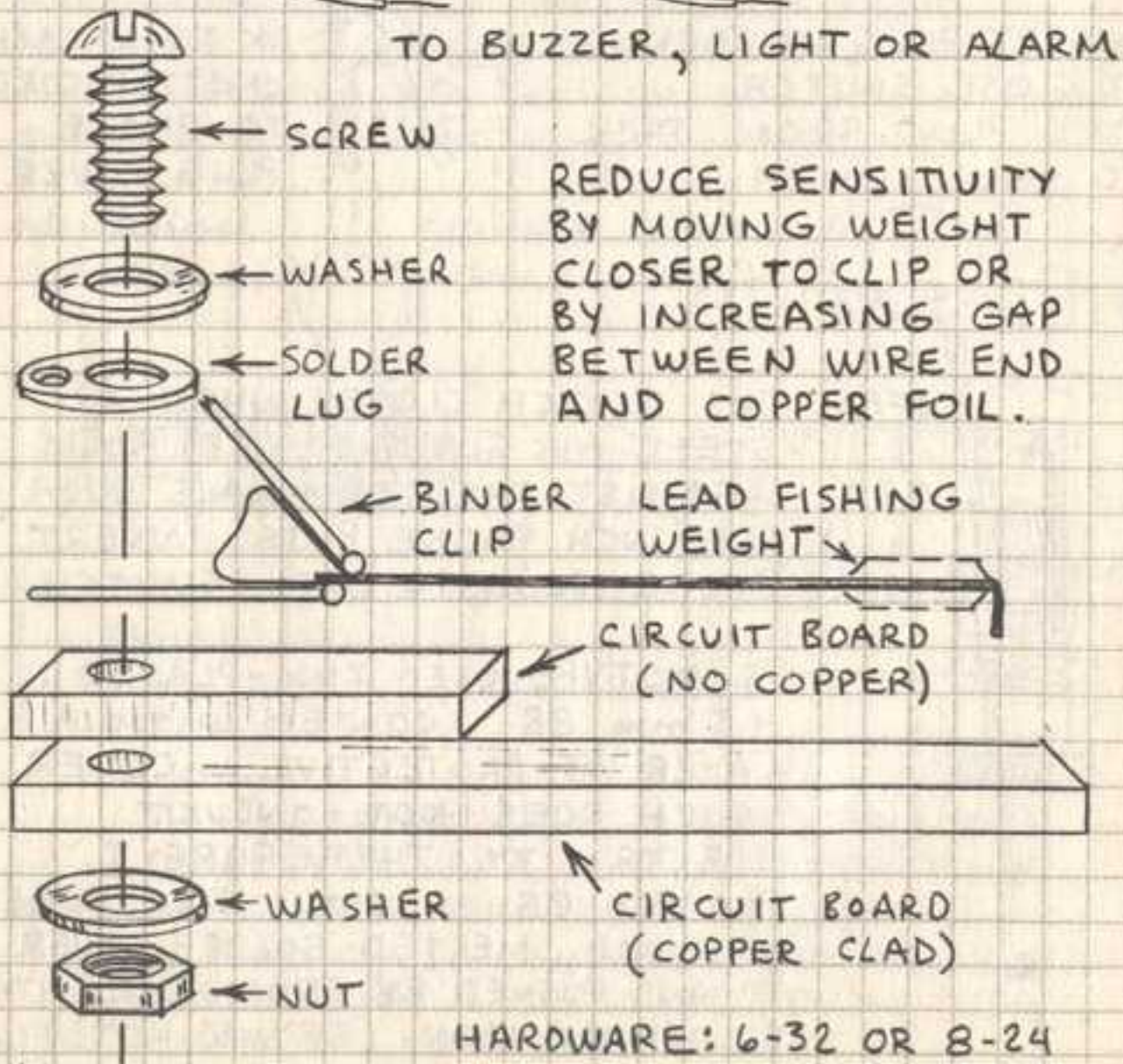

## PIEZOELECTRIC VIBRATION SENSOR

CERTAIN CRYSTALS AND CERAMICS BEND IN RESPONSE TO A VOLTAGE AND GENERATE A VOLTAGE WHEN BENT. THIS PROPERTY IS THE PIEZOELECTRIC EFFECT. A PIEZOELECTRIC BUZZER ELEMENT IS A SENSITIVE VIBRATION SENSOR. TRY THIS:

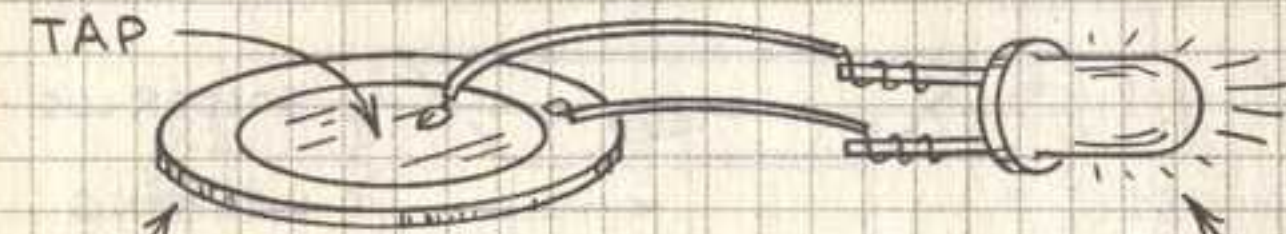

TAP THE PIEZO ELEMENT WITH A PENCIL WHILE LOOKING INTO THE END OF THE LED. EACH TAP WILL CAUSE THE LED TO FLASH.

THE SETUP BELOW IS A SEISMIC SENSOR. THE VERSION I MADE DETECTED TRAINS 1 MILE (1.6 KM) AWAY. CONNECT THE LEADS FROM THE PIEZO ELEMENT TO AN ANALOG VOLT METER. SEISMIC VIBRATIONS WILL CAUSE THE NEEDLE TO JUMP UP TO A VOLT OR SO. THE WEIGHT CAN BE A LEAD FISHING WEIGHT OR A 9-VOLT BATTERY.

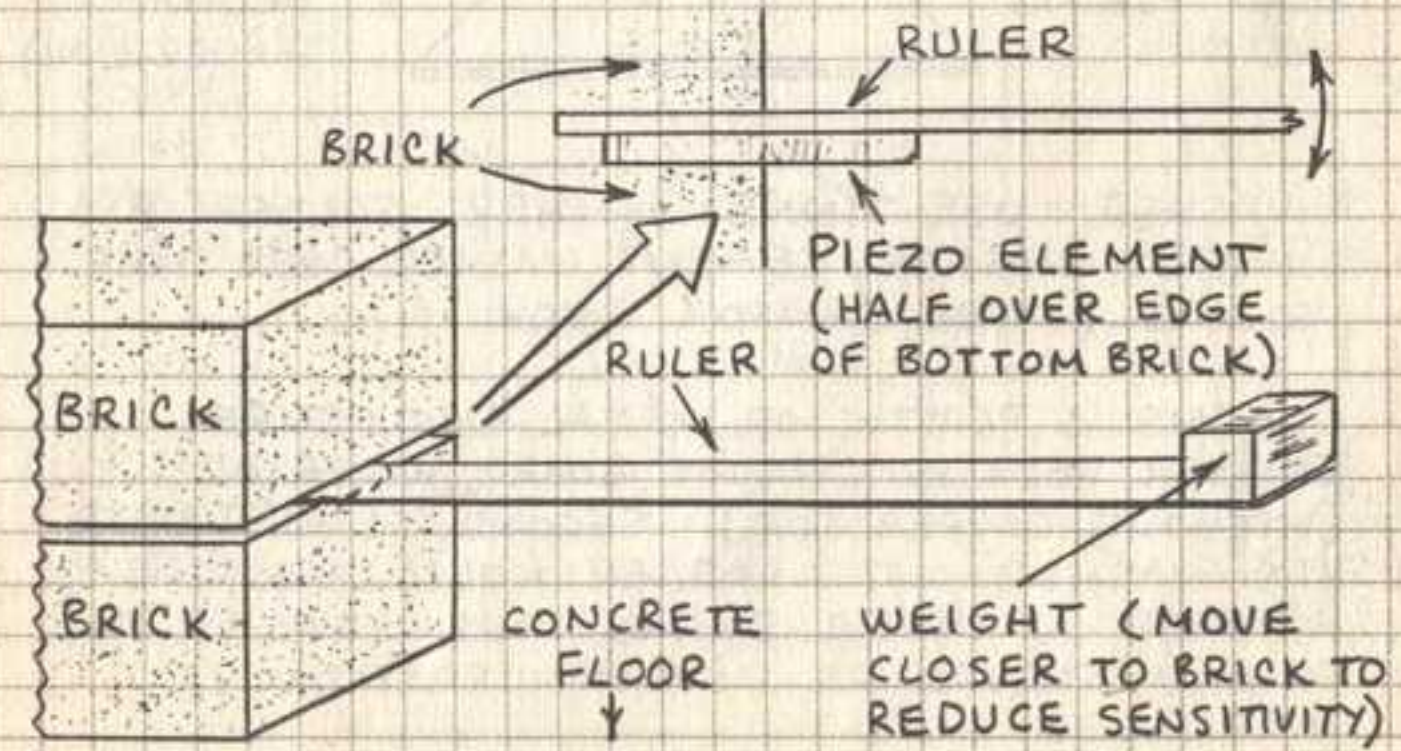

## PENDULUM SWITCH

PENDULUM SWITCHES ARE IDEAL FOR DETECTING TILT AND VIBRATION. THEY ARE USED IN SECURITY SYSTEMS AND SEISMIC SENSORS. PENDULUM SWITCHES ARE EASILY MADE FROM READILY AVAILABLE MATERIALS. HERE'S ONE YOU CAN MAKE.

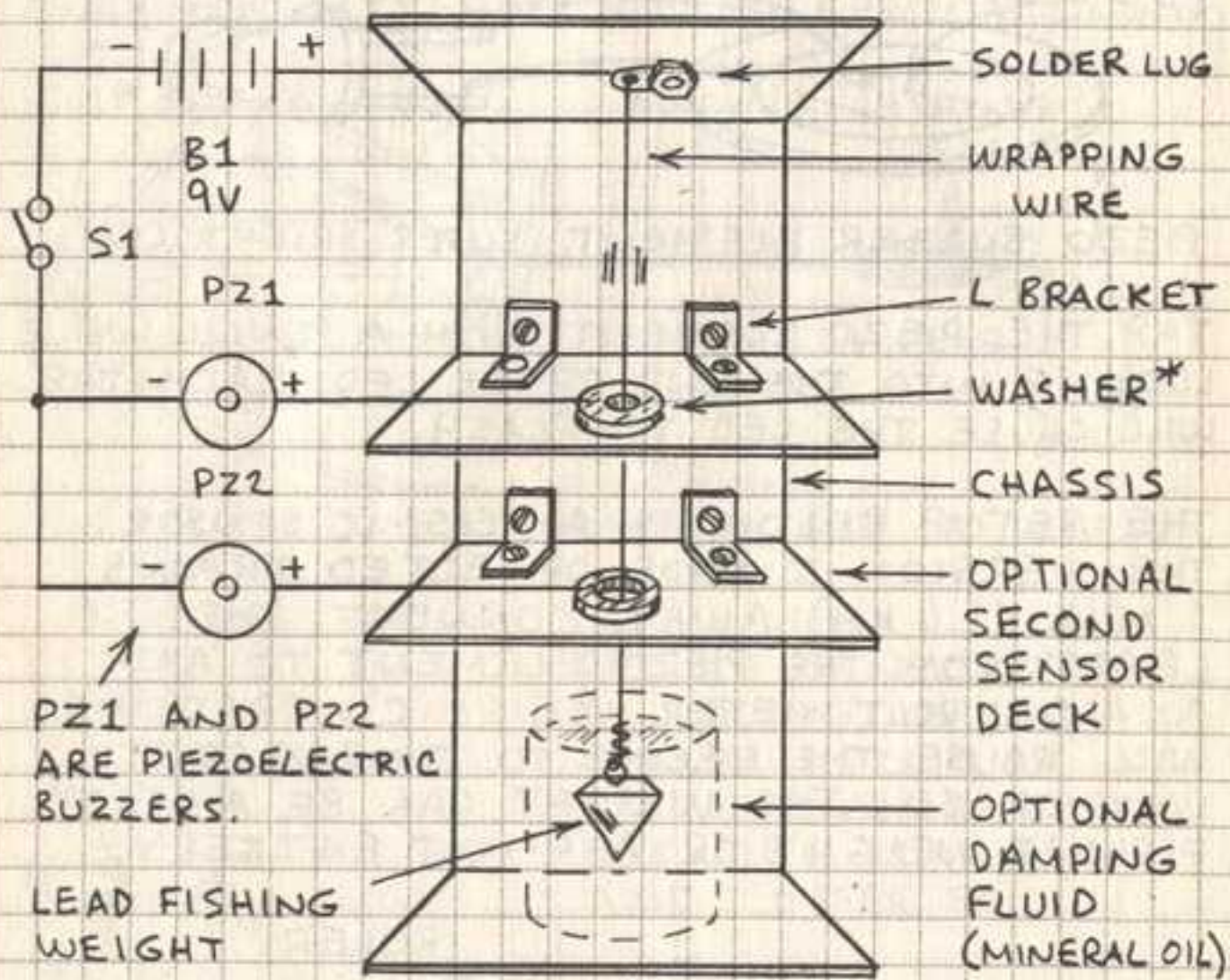

\*WASHER—USE TINNED WASHER. SOLDER A WIRE TO WASHER. CEMENT WASHER OVER HOLE DRILLED IN THE SENSOR DECK.

CHASSIS IS PLASTIC OR METAL ENCLOSURE. SENSOR DECK IS CIRCUIT BOARD MATERIAL (WITHOUT COPPER FOIL). SECOND SENSOR DECK HAS WASHER WITH LARGER HOLE THAN WASHER IN UPPER DECK. THIS PROVIDES A SECOND SIGNAL AS TILT OR VIBRATION IS INCREASED.

16

## PENDULUM QUADRANT SWITCH

REPLACE THE SIMPLE GO-NO GO WASHER SWITCH ON THE FACING PAGE WITH A CIRCULAR ARRAY OF FOUR OR MORE SEGMENTS AND YOU CAN MAKE A SWITCH WHICH INDICATES THE DIRECTION OF TILT OR VIBRATION.

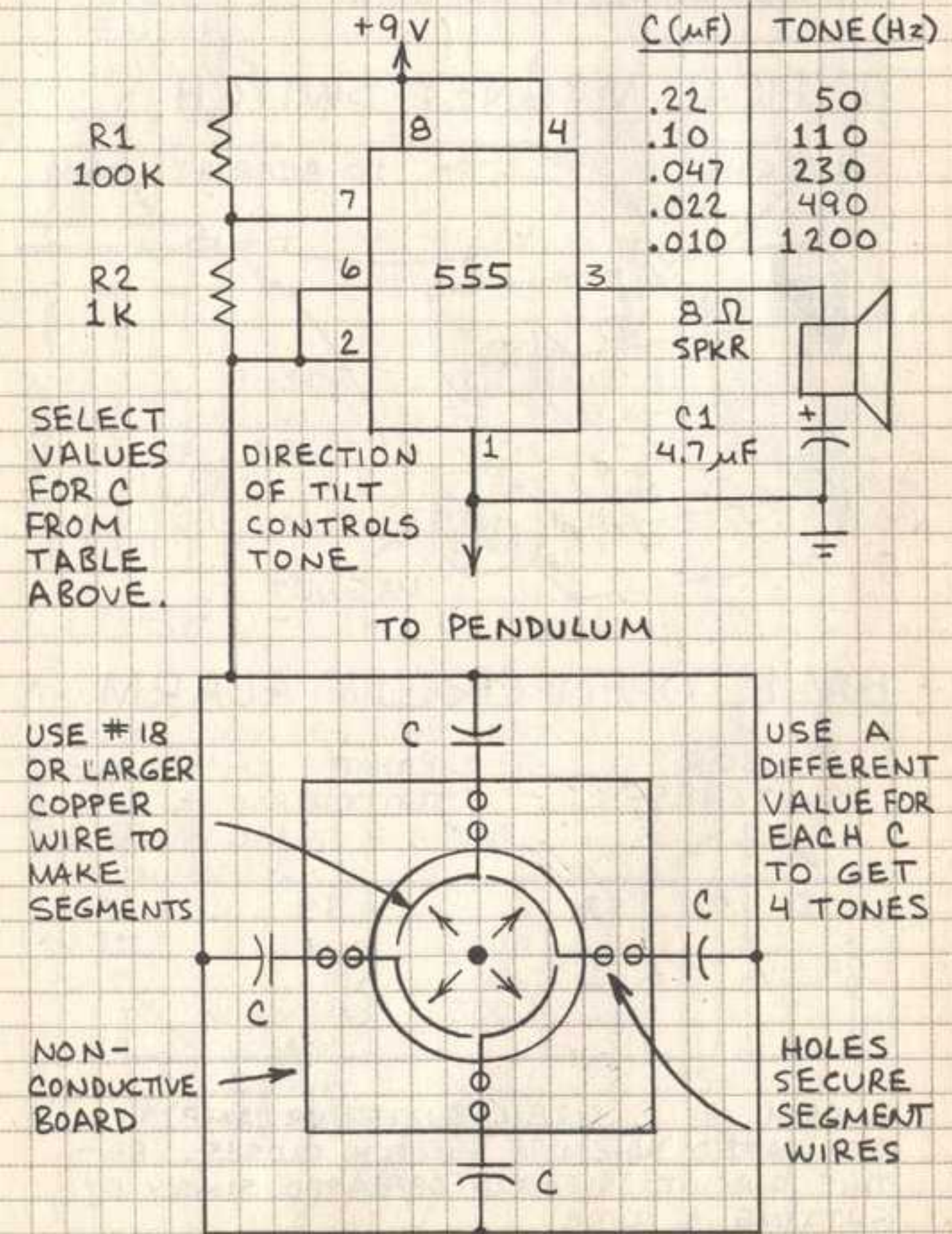

17

## SWITCH-TYPE ALARM SYSTEMS

MANY SECURITY ALARM SYSTEMS USE ON-OFF (SPST) SWITCHES TO DETECT OPEN DOORS AND WINDOWS OR VIBRATION. MAGNET SWITCHES, METAL FOIL (WHICH BREAKS WHEN A WINDOW IS BROKEN) AND VIBRATION SENSORS ARE OFTEN USED.

### TYPICAL MAGNET SWITCH

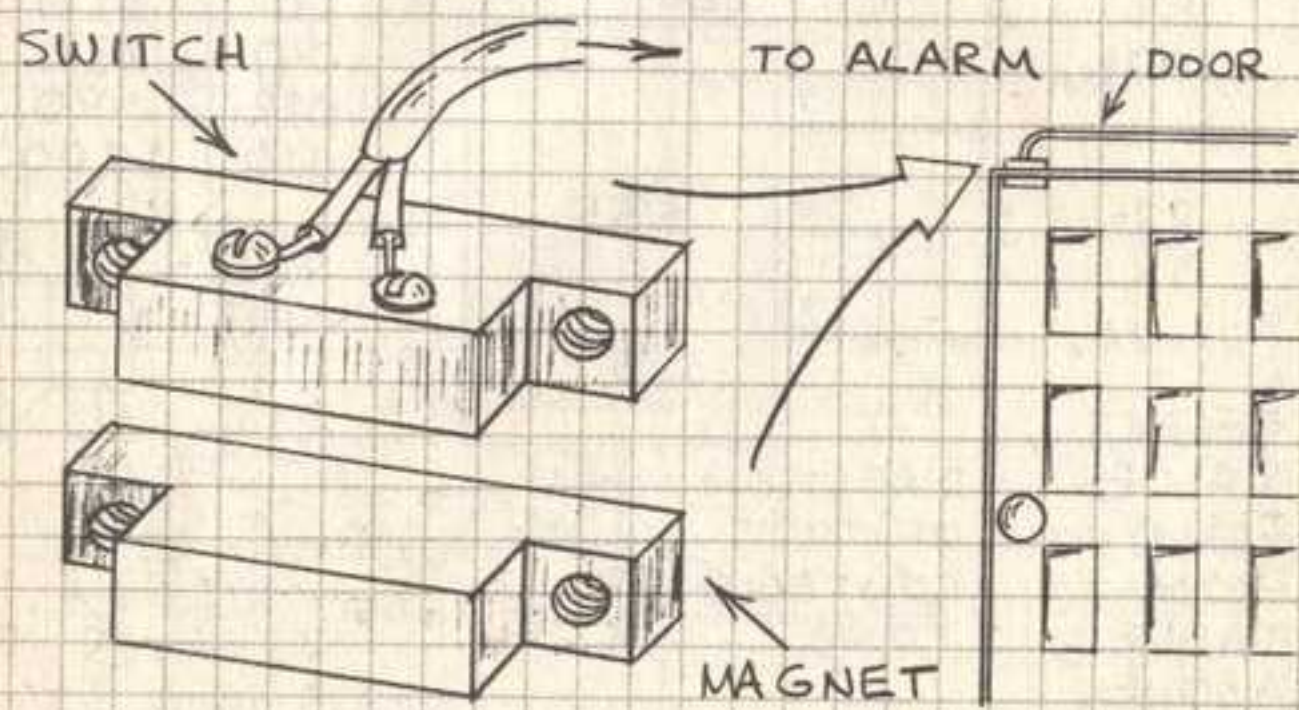

### BASIC OPEN-CIRCUIT ALARM

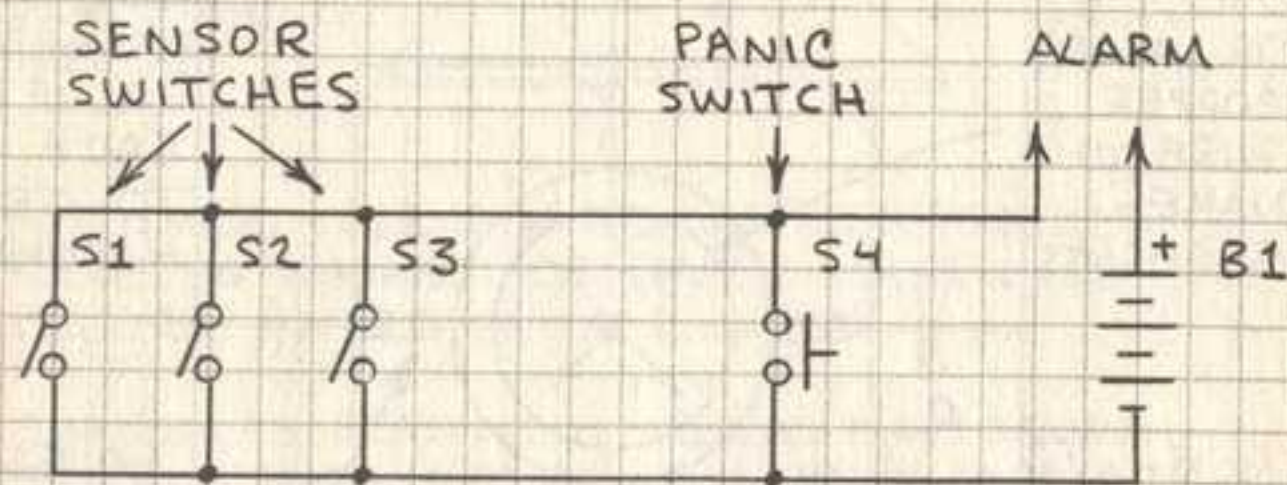

ALARM (BELL, SIREN, BUZZER OR LAMP) IS ACTIVATED WHEN A SWITCH CLOSES. BUT THIS CIRCUIT IS EASILY DEFEATED SIMPLY BY CUTTING A WIRE.

18

## IMPROVED OPEN-CIRCUIT ALARM

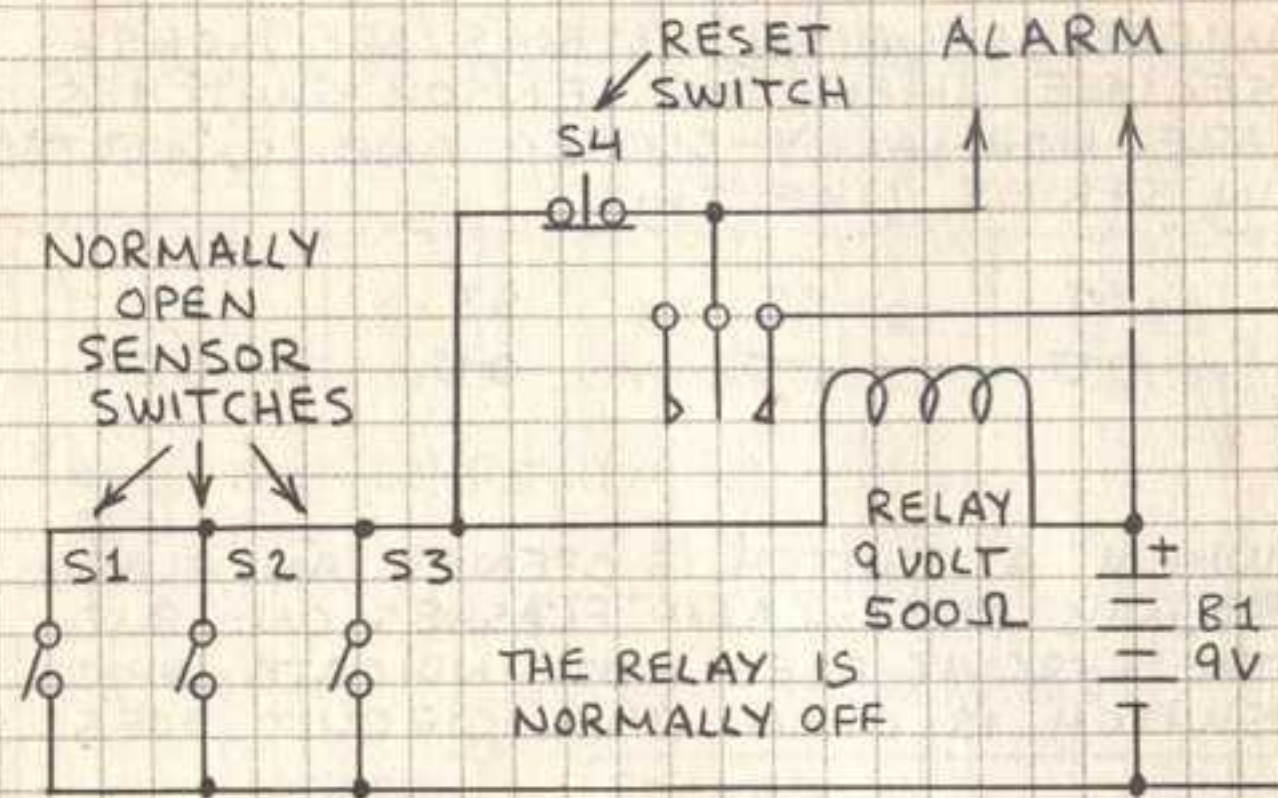

WHEN A SENSOR SWITCH IS CLOSED THE RELAY PULLS IN AND THE ALARM STAYS ON UNTIL THE RESET SWITCH IS OPENED. THE CIRCUIT CAN BE DEFEATED BY CUTTING A SWITCH WIRE BEFORE CLOSING A SENSOR.

### CLOSED-CIRCUIT ALARM

THIS CIRCUIT MONITORS THE SENSOR SWITCHES CONTINUOUSLY. THE ALARM IS ACTIVATED IF A SWITCH WIRE IS CUT. THE RELAY DRAWS CURRENT CONTINUOUSLY.

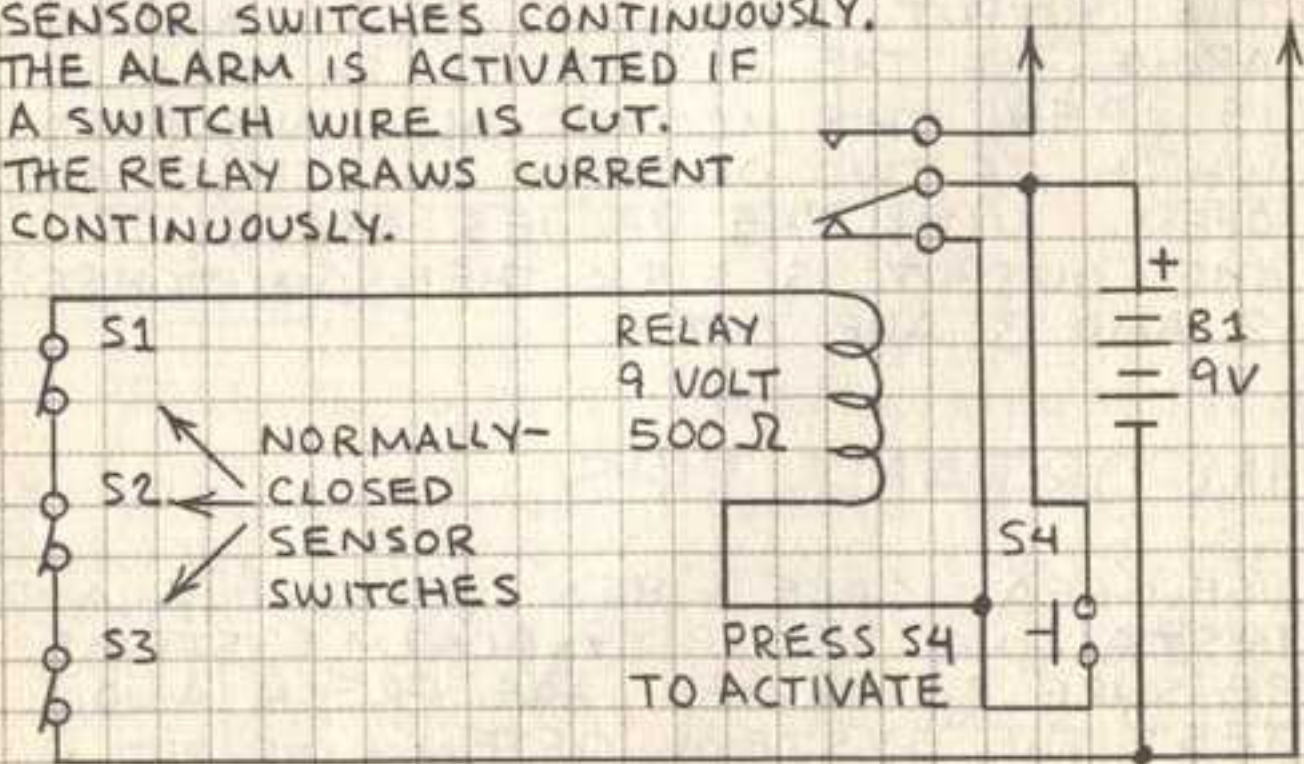

19

## INTELLIGENT SWITCH SENSOR

WIRED SECURITY SYSTEMS ARE MORE SECURE WHEN THE SENSOR SWITCHES ARE NORMALLY-CLOSED AND CONNECTED IN SERIES LIKE THIS:

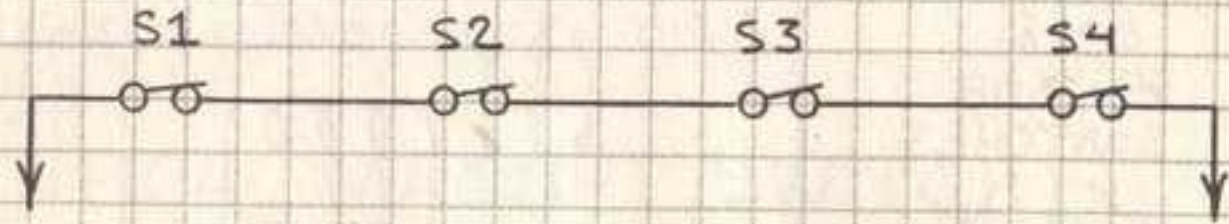

WHEN A SWITCH IS OPENED AN ALARM SOUNDS OR A LAMP FLASHES ON. BUT THE CIRCUIT DOES NOT INDICATE WHICH SWITCH IS OPEN. THIS CIRCUIT DOES:

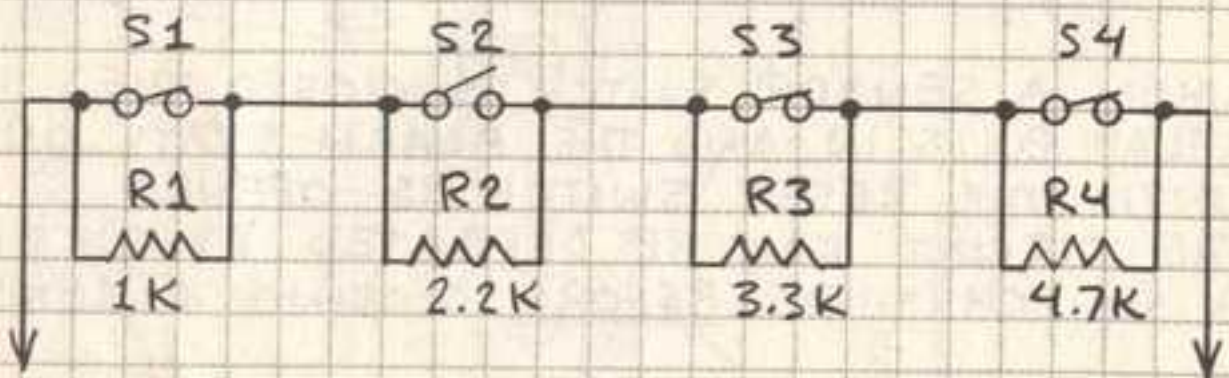

NORMALLY THE OUTPUT IS CLOSE TO 0 OHM. WHEN A SWITCH IS OPENED, A CORRESPONDING RESISTANCE APPEARS AT THE OUTPUT. WITH THE RESISTANCES ABOVE, IF THE OUTPUT IS 2.2K THEN S2 IS OPEN. THIS METHOD ALSO INDICATES WHICH OF TWO OR MORE SWITCHES ARE OPEN. WITH THE VALUES ABOVE, IF THE OUTPUT IS 5.5K, THEN SWITCHES 2 AND 3 ARE OPEN.

## IMPORTANT TIPS

USE GREAT CARE WHEN DESIGNING AND INSTALLING SECURITY ALARM SYSTEMS. BE SURE BATTERIES ARE FRESH AND TEST THE SYSTEM OFTEN.

20

## INTELLIGENT SECURITY ALARM

S1-S5: NORMALLY CLOSED MAGNET SWITCHES

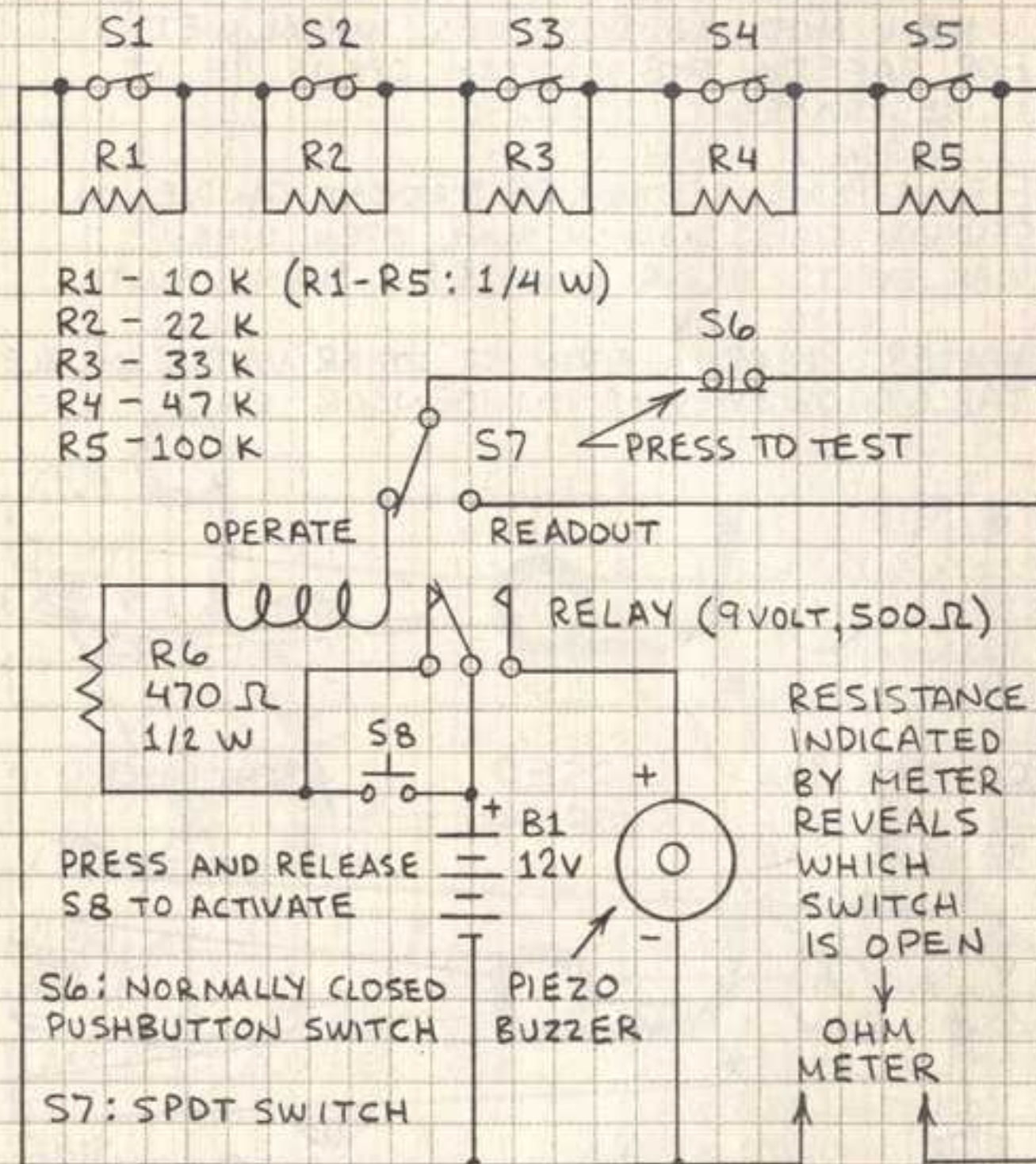

### OPERATION:

1. PRESS S6 TO TEST. (BUZZER WILL SOUND.)
2. IF ALARM SOUNDS, TOGGLE S7 TO THE READOUT POSITION TO SILENCE BUZZER. THEN SWITCH ON OHM METER AND READ THE RESISTANCE. IF RESISTANCE IS ONLY A FEW OHMS, THE BATTERY IS TOO WEAK TO PULL IN THE RELAY.

21

# FIRE OR WATER SENSOR

THIS NORMALLY-CLOSED SWITCH IS KEPT CLOSED BY A SUBSTANCE THAT MELTS WHEN HOT OR DISSOLVES WHEN WET. FOR SAFETY THE SWITCH OPENS IF IT IS DESTROYED.

**FIRE:** PLACE SECTION OF BIRTHDAY CANDLE IN SENSOR GAP. SWITCH WILL OPEN WHEN WAX MELTS OR IF CLOTHES PIN BURNS AWAY.

**WATER:** PLACE ASPIRIN OR OTHER WATER SOLUBLE TABLET OR CAPSULE IN SENSOR GAP.

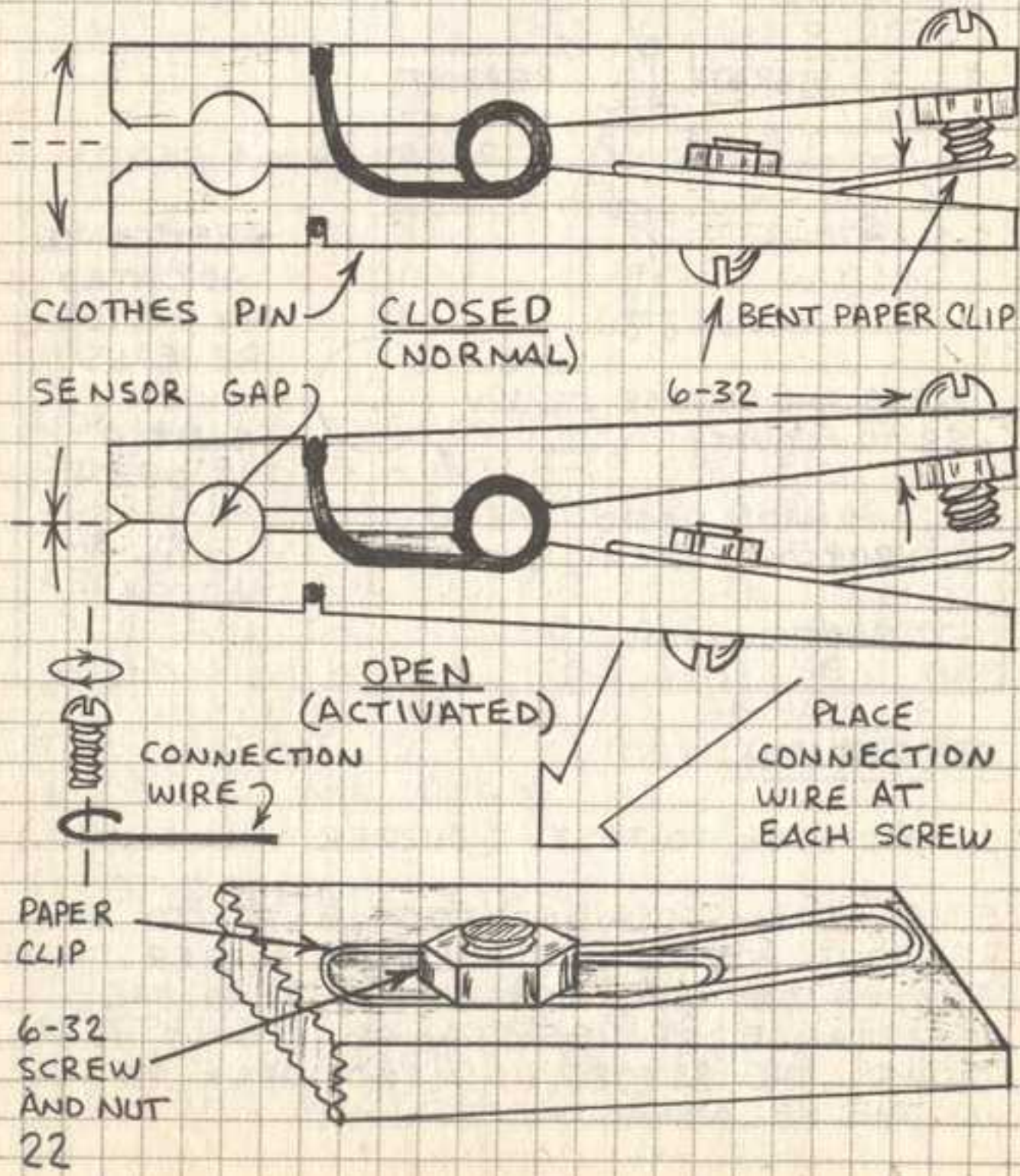

# PULL SWITCH

USE THIS SWITCH TO ACTIVATE A LIGHT, SIREN OR BUZZER WHEN A DOOR, WINDOW OR MAIL BOX IS OPENED. THE VERSION SHOWN HERE IS NORMALLY OPEN. THIS MEANS THE SWITCH CAN BE BYPASSED BY CUTTING ITS LEADS. FOR NORMALLY CLOSED OPERATION USE THE SWITCH ON FACING PAGE AND ADJUST SCREW SO THAT IT TOUCHES THE PAPER CLIP WHEN THE PULL STRIP IS IN PLACE. A THICKER PULL STRIP MIGHT BE NECESSARY IF YOU USE THE NORMALLY CLOSED SWITCH. USE SCREWS OR CEMENT TO MOUNT SWITCH.

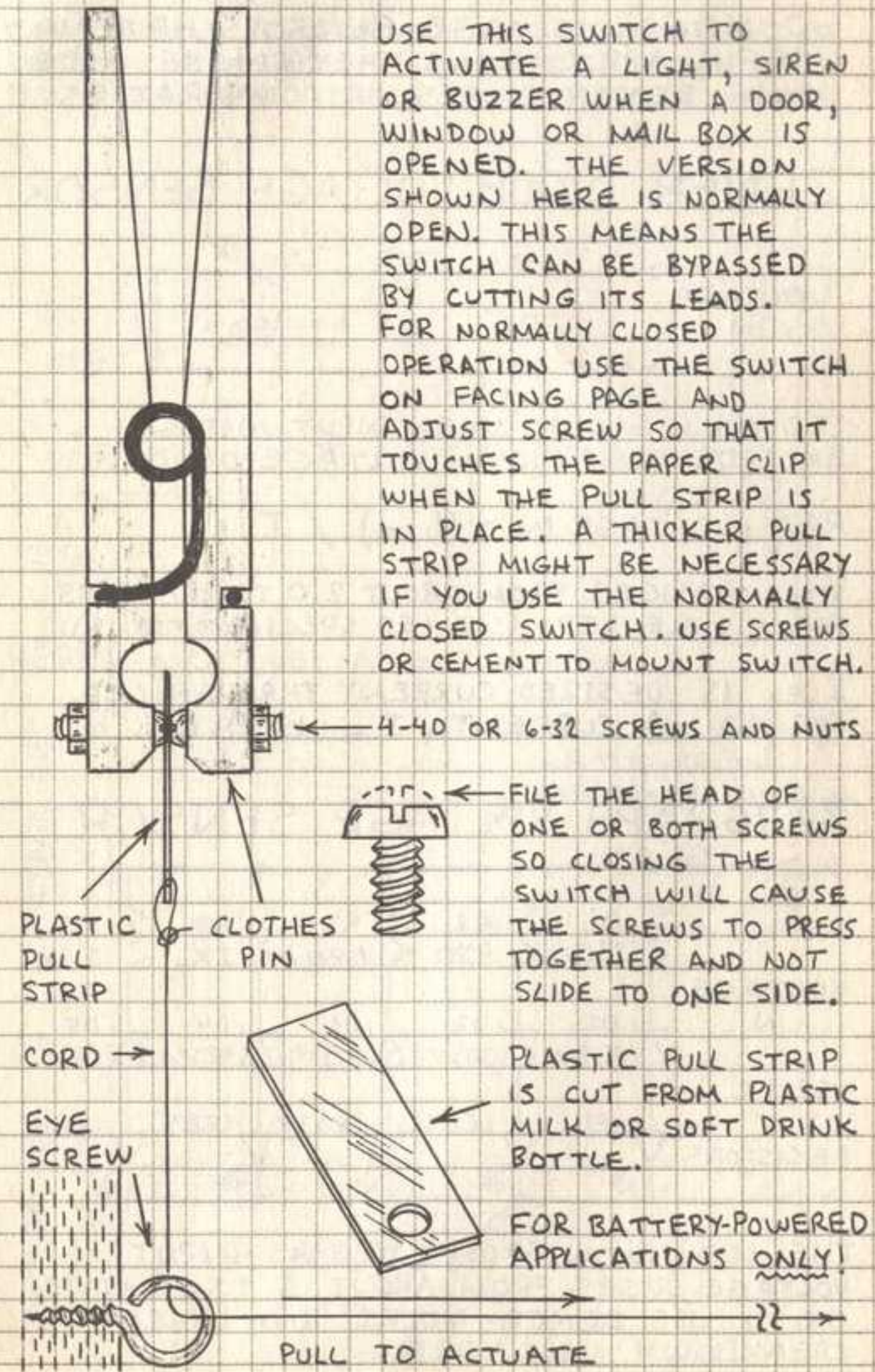

## VOLTAGE SENSORS

GO-NOGO VOLTAGE SENSORS HAVE MANY USEFUL APPLICATIONS. THEY CAN BE MADE USING ZENER DIODES OR COMPARATORS.

### ZENER DIODE VOLTAGE SENSOR

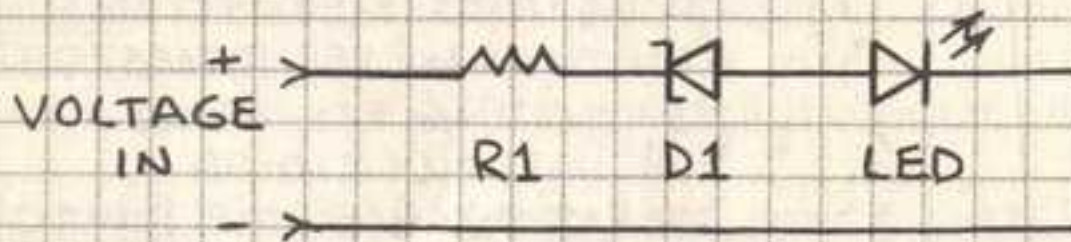

LED WILL GLOW WHEN INPUT VOLTAGE EXCEEDS BREAKDOWN VOLTAGE OF D1.

$$R1 = (\text{VOLTAGE IN} - V_{LED}) / I_{LED}$$

$V_{LED}$  RANGES FROM ABOUT 2.0 TO 2.7 VOLTS FOR VISIBLE LEDs (SEE LED SPECIFICATIONS).

$I_{LED}$  IS DESIRED CURRENT THROUGH LED. FOR 10 mA CURRENT,  $I_{LED}$  IS 0.01.

### BARGRAPH VOLTAGE SENSOR

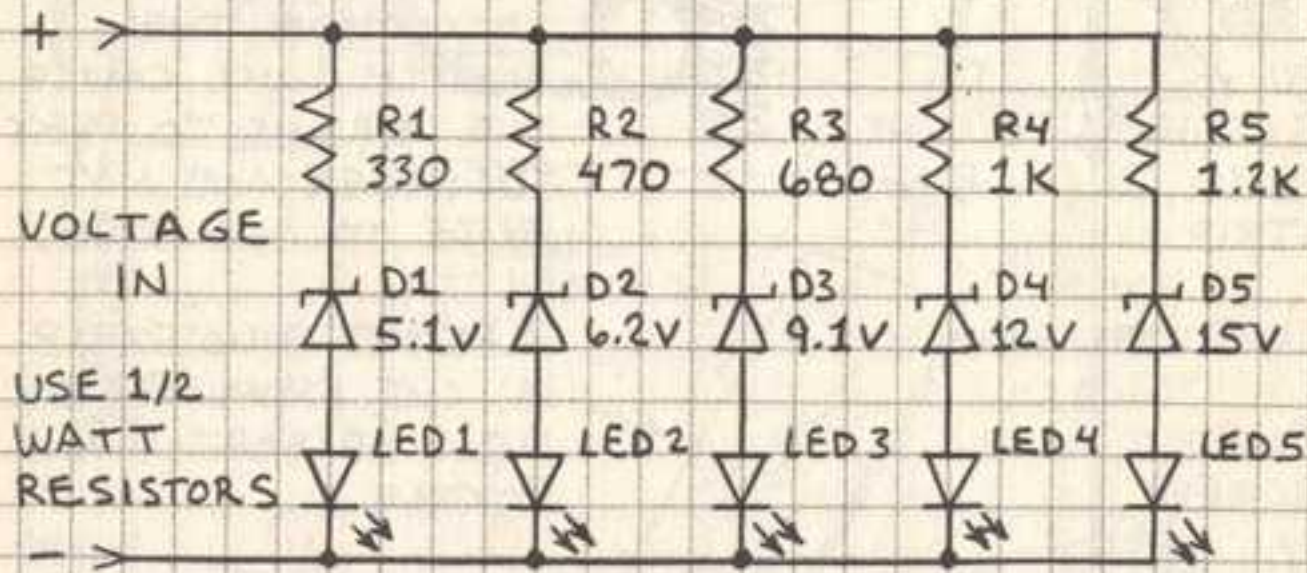

THE LEDs GLOW FROM 1 TO 5 AS INPUT VOLTAGE RISES FROM ABOUT 5 TO 15 VOLTS. OK TO USE ZENER DIODES WITH OTHER BREAKDOWN VOLTAGES.

24

## COMPARATOR VOLTAGE SENSOR

THIS BASIC COMPARATOR VOLTAGE SENSOR DETECTS PRESENCE OF A VOLTAGE ABOVE OR BELOW AN ADJUSTABLE REFERENCE VOLTAGE.

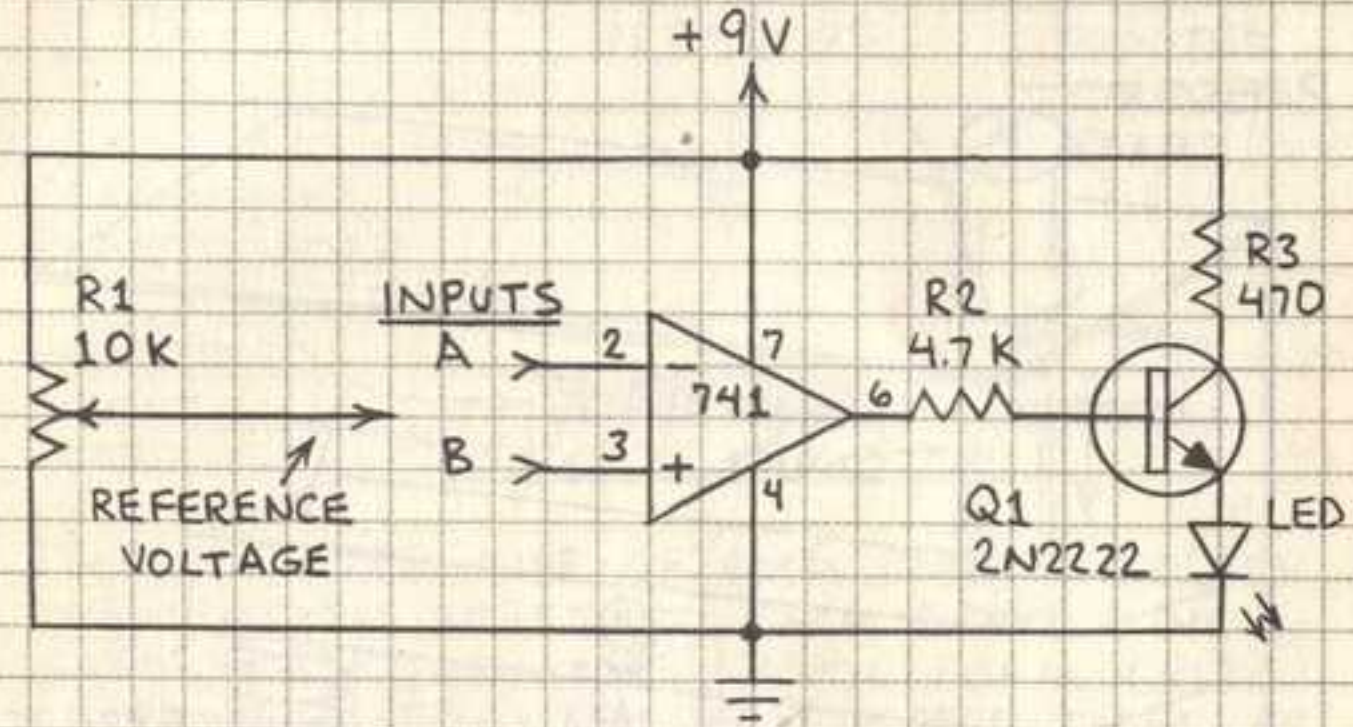

REFERENCE VOLTAGE TO INPUT B:

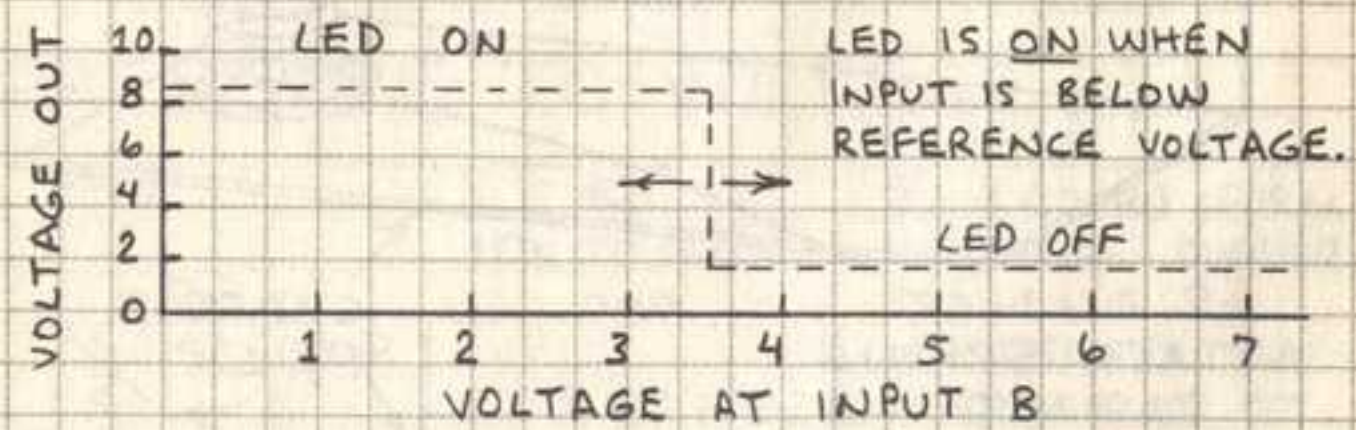

REFERENCE VOLTAGE TO INPUT A:

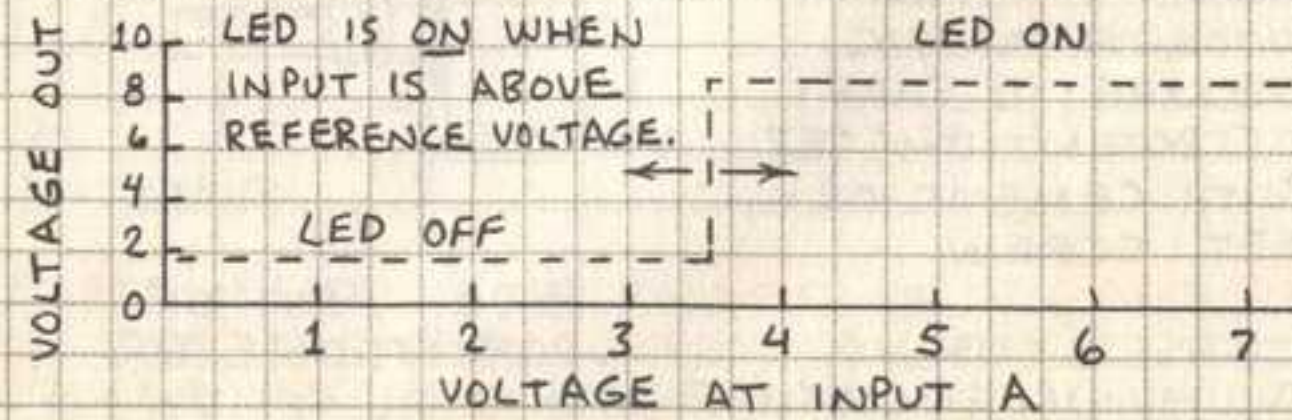

25

## ANALOG PRESSURE SENSOR

PRESSURE SENSORS ARE EASILY MADE FROM SIMPLE MATERIALS. THIS ONE CHANGES THE RESISTANCE OF A POTENTIOMETER.

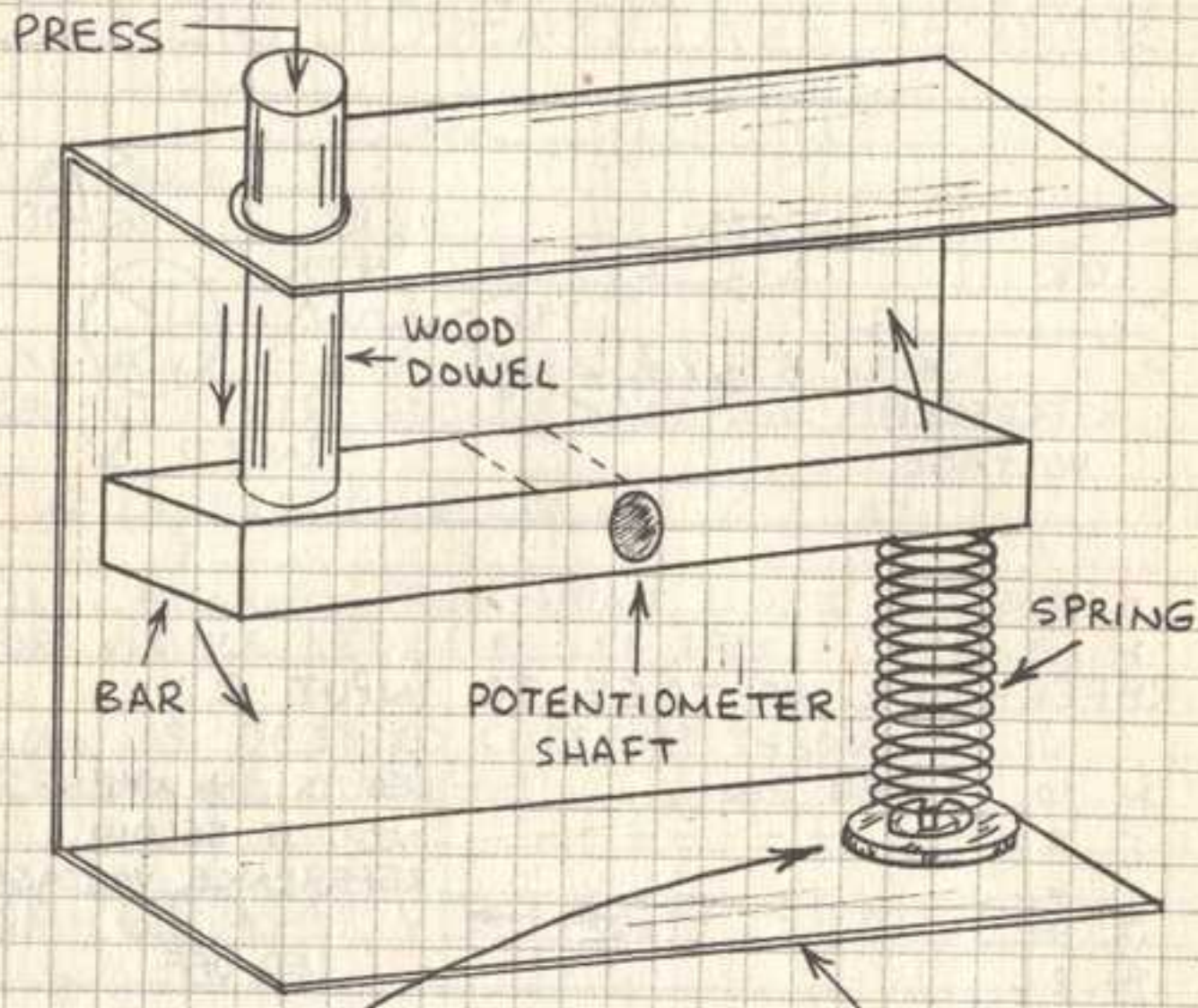

ATTACH SPRING TO BAR AND CHASSIS WITH SCREW, NUT AND WASHER.

MAKE BAR FROM WOOD OR PLASTIC. SECURE TO SHAFT OF POTENTIOMETER WITH CEMENT OR SET SCREW.

CHASSIS: USE ALUMINUM ENCLOSURE.

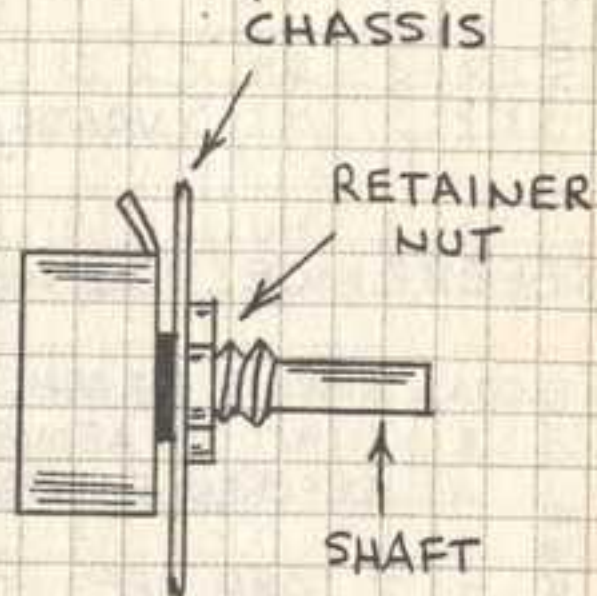

SIDE VIEW OF POTENTIOMETER INSTALLATION

## SIMPLE PRESSURE SENSOR

THIS SIMPLE SENSOR DOES NOT PROVIDE THE CONSISTENCY OF A POTENTIOMETER, BUT IT IS VERY EASY TO MAKE.

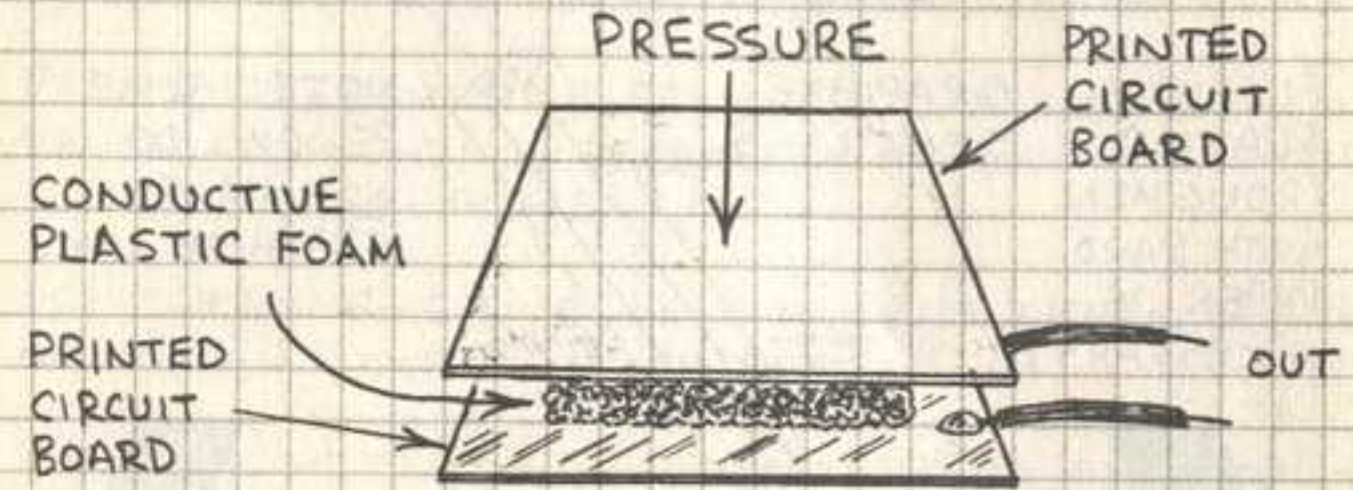

POLISH COPPER SIDE OF BOTH BOARDS. SOLDER CONNECTION WIRES TO EACH BOARD. THEN SANDWICH CONDUCTIVE PLASTIC FOAM (USED TO PROTECT ICs) BETWEEN COPPER SIDES OF THE BOARDS. PLACE SENSOR IN SMALL PLASTIC BOX TO HOLD IT TOGETHER.

## PRESSURE-TO-VOLTAGE

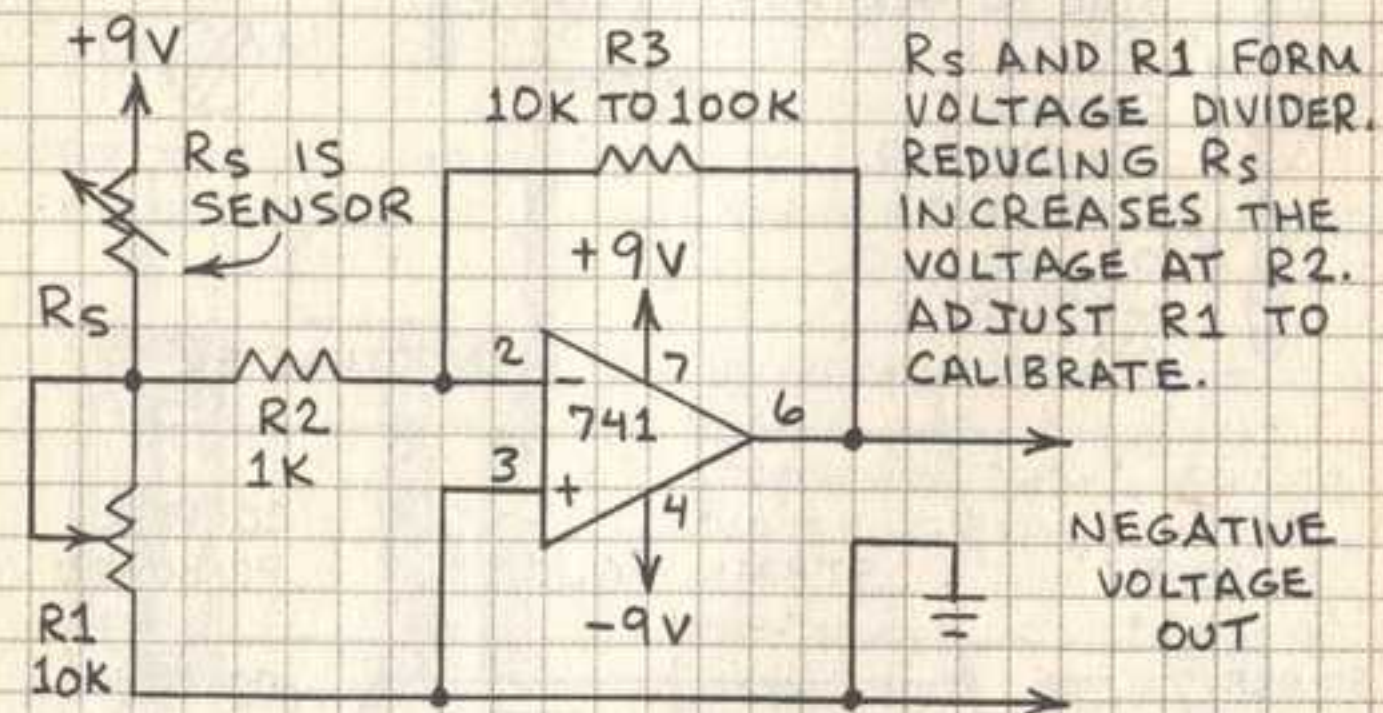

EXPERIMENT WITH VALUES OF R1 AND R3 TO GIVE DESIRED OUTPUT. CONNECT  $R_s$  TO -9V TO GIVE POSITIVE VOLTAGE OUT.

# STRAIN SENSORS

A STRAIN GAUGE IS A RESISTOR HAVING A RESISTANCE WHICH CHANGES WHEN THE RESISTOR IS BENT OR TWISTED. YOU CAN EASILY MAKE A WORKING STRAIN GAUGE.

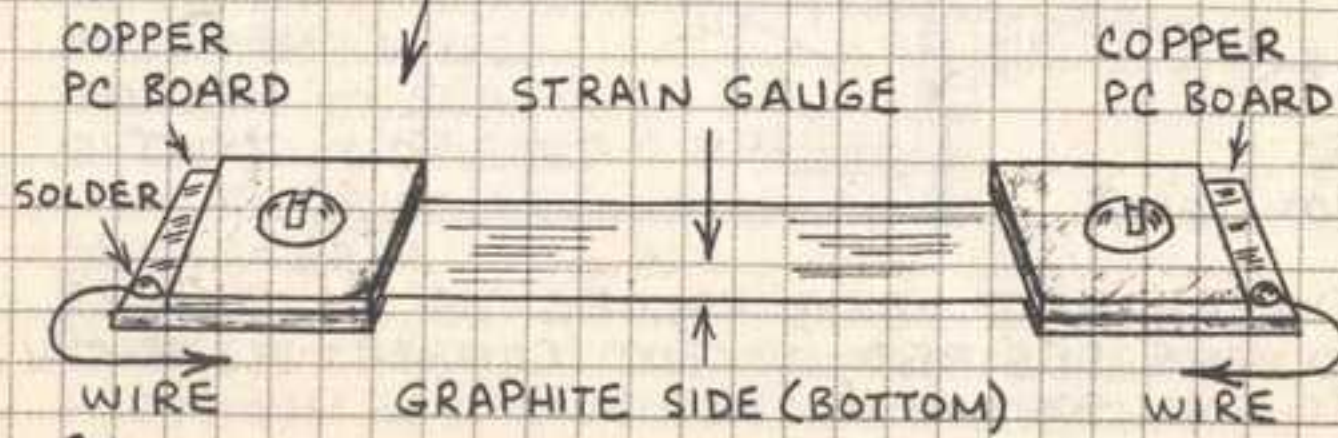
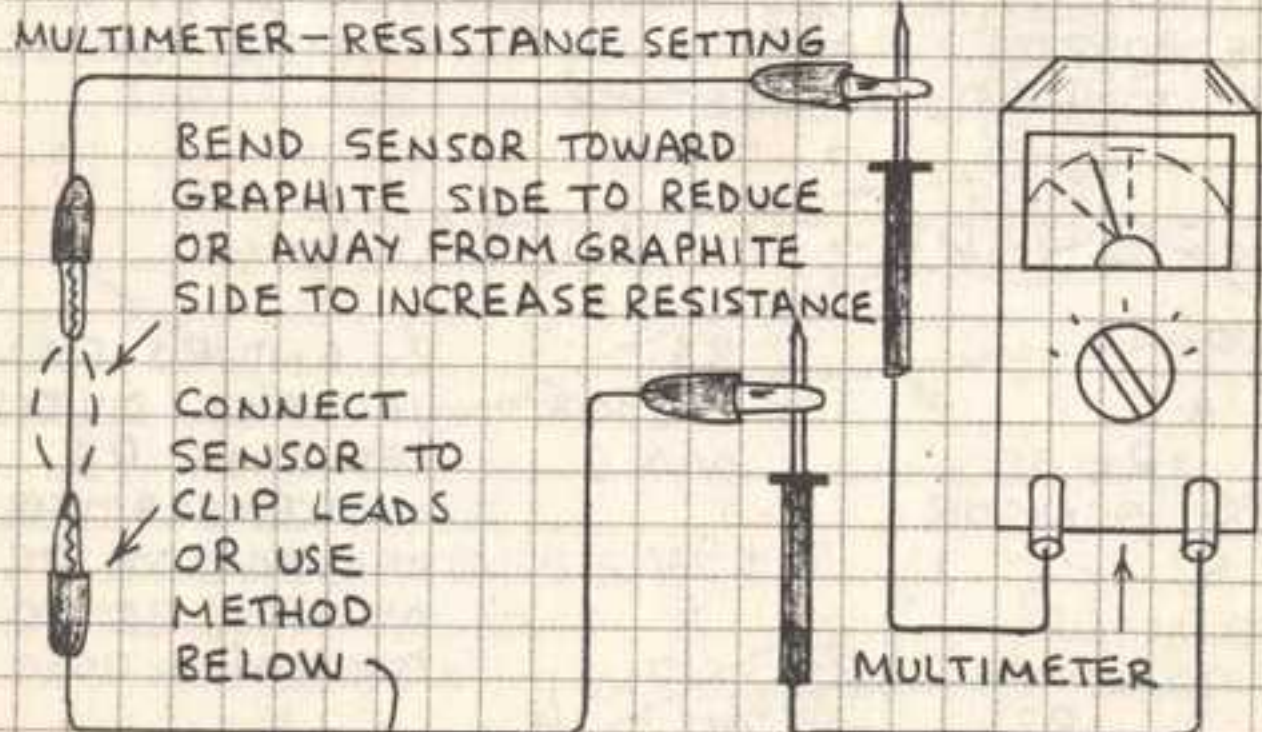
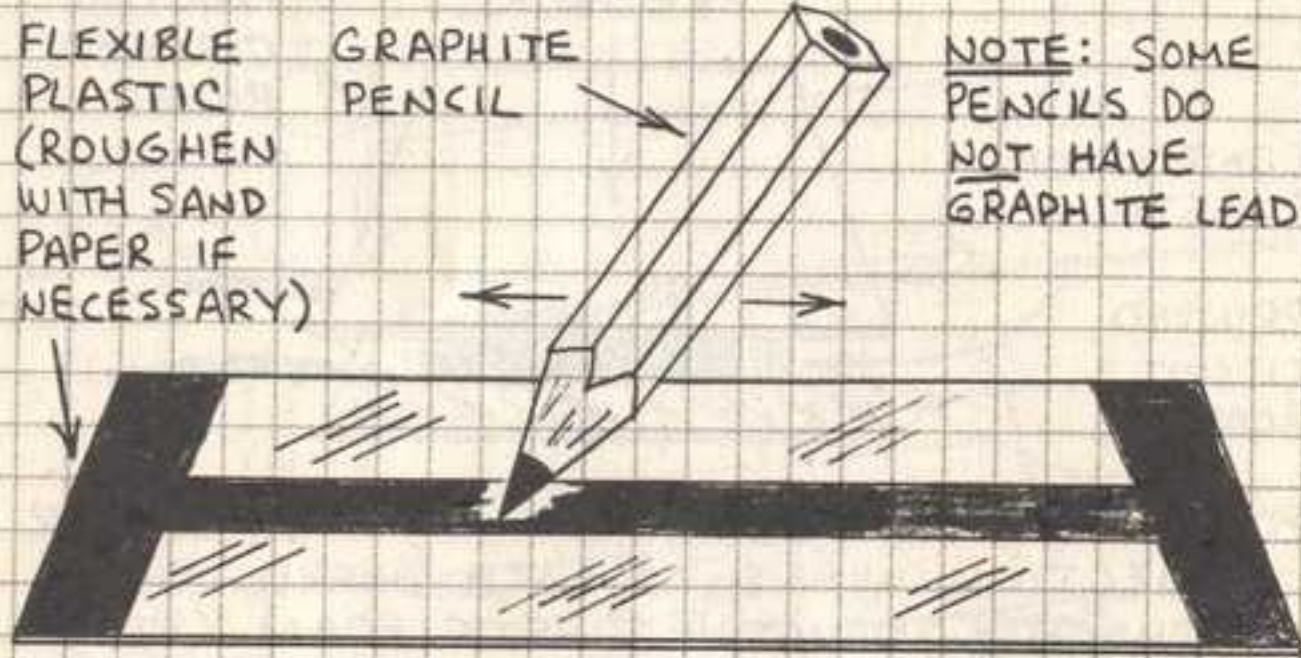

# STRAIN SENSOR APPLICATIONS

MY FIRST STRAIN GAUGE PROJECT MONITORED THE MOVEMENT OF A MODEL ROCKET INSTALLED IN A WIND TUNNEL STRAPPED TO THE SIDE OF A 1966 CHEVY. IT WORKED. HERE ARE OTHER APPLICATIONS:

PRESSURE-SENSITIVE RESISTOR - USE STRAIN SENSOR TO CONTROL FREQUENCY OF AUDIO OSCILLATOR OR GAIN OF AMPLIFIER.

PRESSURE-SENSITIVE SWITCH - USE STRAIN SENSOR AS VERY SENSITIVE TOUCH SWITCH.

ACCELEROMETER - ATTACH WEIGHT TO ONE END OF STRAIN SENSOR. MOVEMENT WILL CHANGE RESISTANCE OF SENSOR.

SCALE - ATTACH STRAIN SENSOR TO BOTTOM SIDE OF FLEXIBLE PLATFORM. CALIBRATE BY PLACING ITEMS OF KNOWN WEIGHT ON PLATFORM.

EXPERIMENTAL - ROBOTICS AND DETECTION OF VIBRATION AND MOVEMENT.

# STRAIN SENSOR DESIGNS

TRY THESE VARIATIONS TO INCREASE SENSITIVITY OR MAKE SINGLE-ENDED SENSORS.

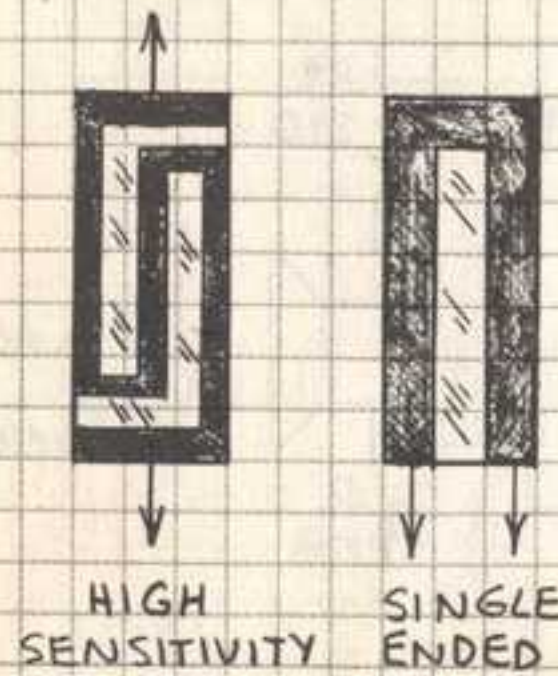

CALIBRATE OR ADJUST RESISTANCE BY LIGHTLY STROKING PENCIL ERASER ACROSS GRAPHITE.

TRY COATING GRAPHITE WITH THIN LAYER OF PAINT TO PROTECT FROM UNWANTED CHANGES IN RESISTANCE.



## STRAIN SENSOR RELAY

THIS CIRCUIT CAN BE ADJUSTED TO PULL IN A RELAY WHEN SENSOR IS BENT OR TWISTED.

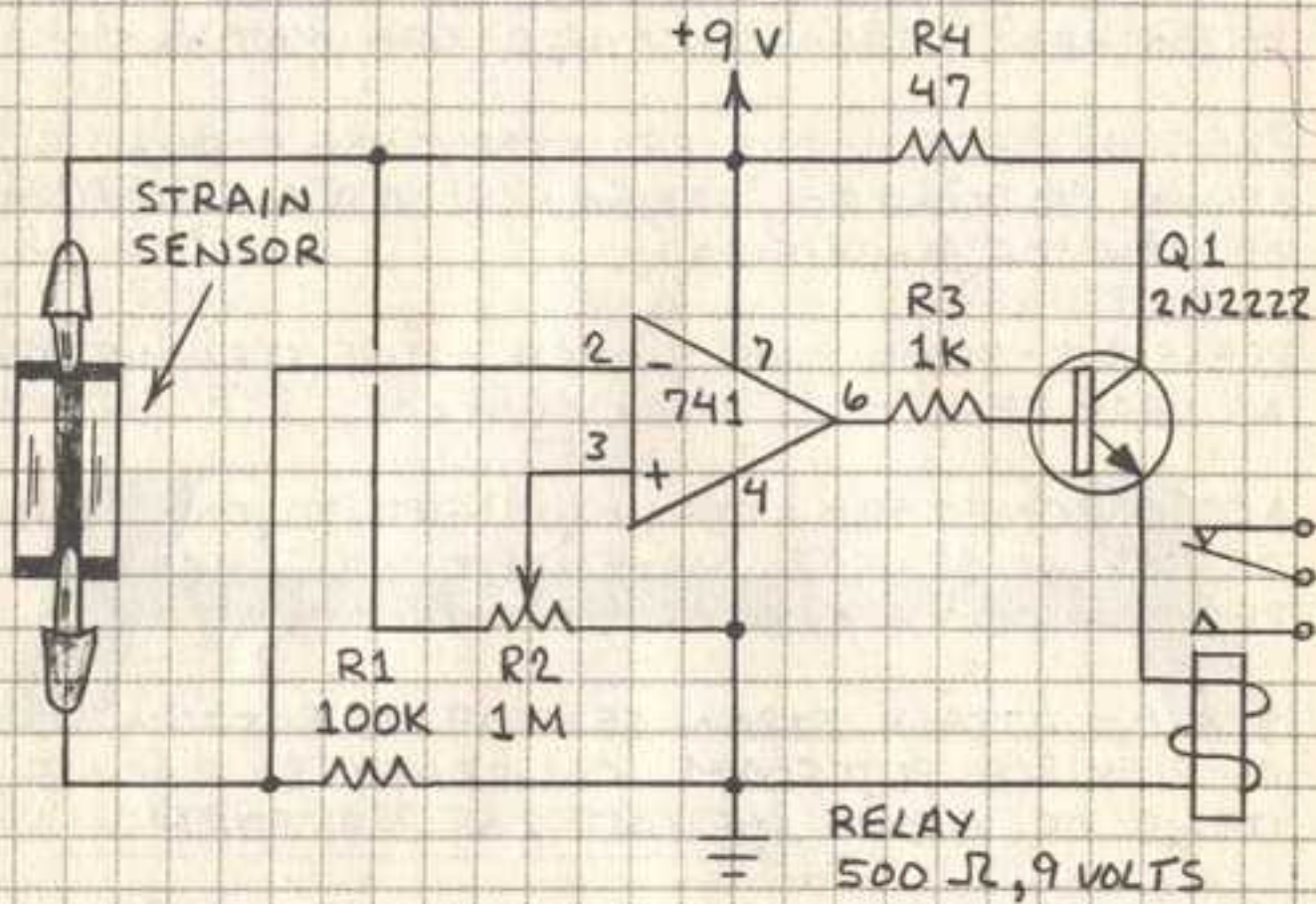

## STRAIN SENSOR TONE GENERATOR

THE FREQUENCY OF THE TONE FROM THE SPEAKER CHANGES WHEN THE SENSOR IS BENT OR TWISTED.

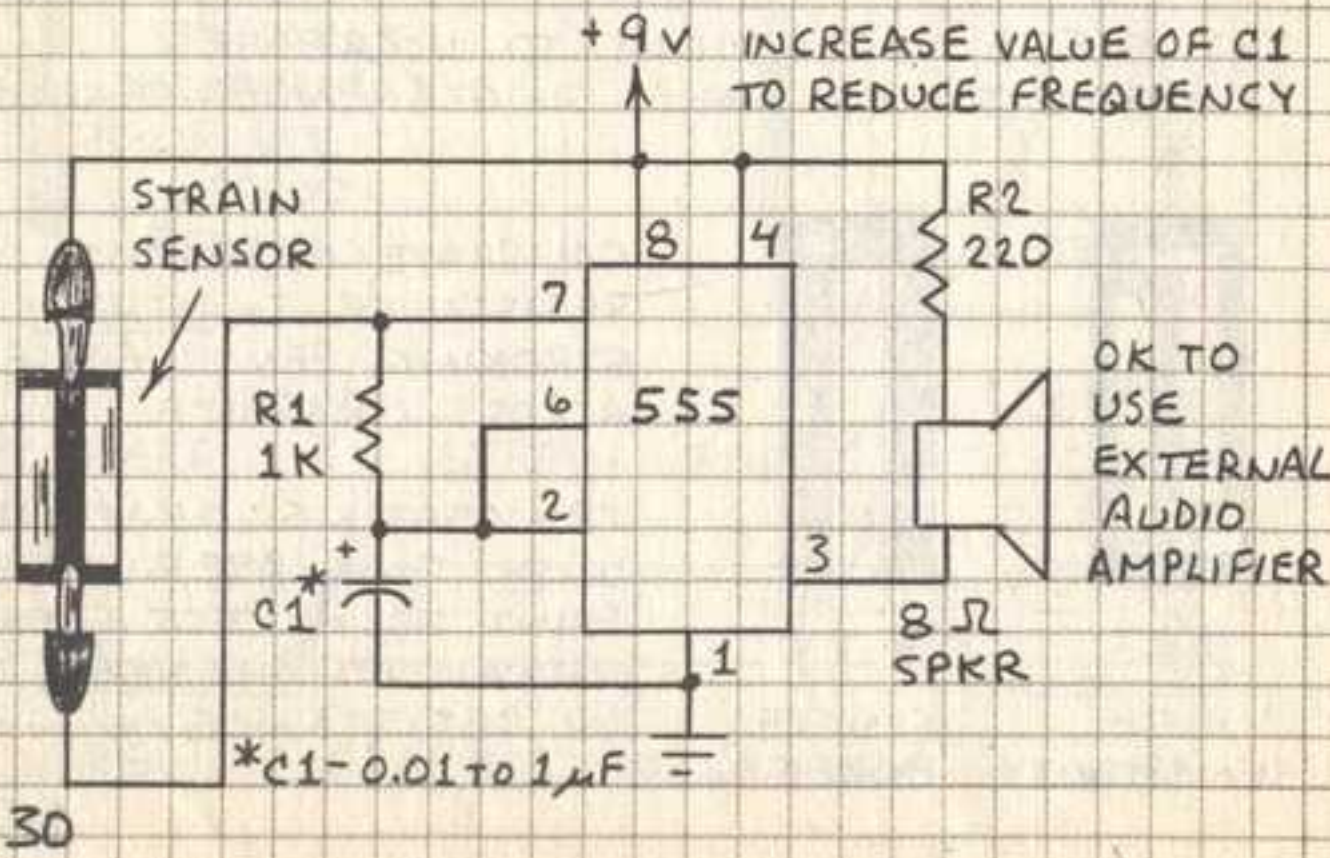

## STRAIN SENSOR AMPLIFIER

THIS CIRCUIT CONVERTS THE CHANGE IN THE RESISTANCE OF A STRAIN SENSOR TO A CHANGE IN VOLTAGE.

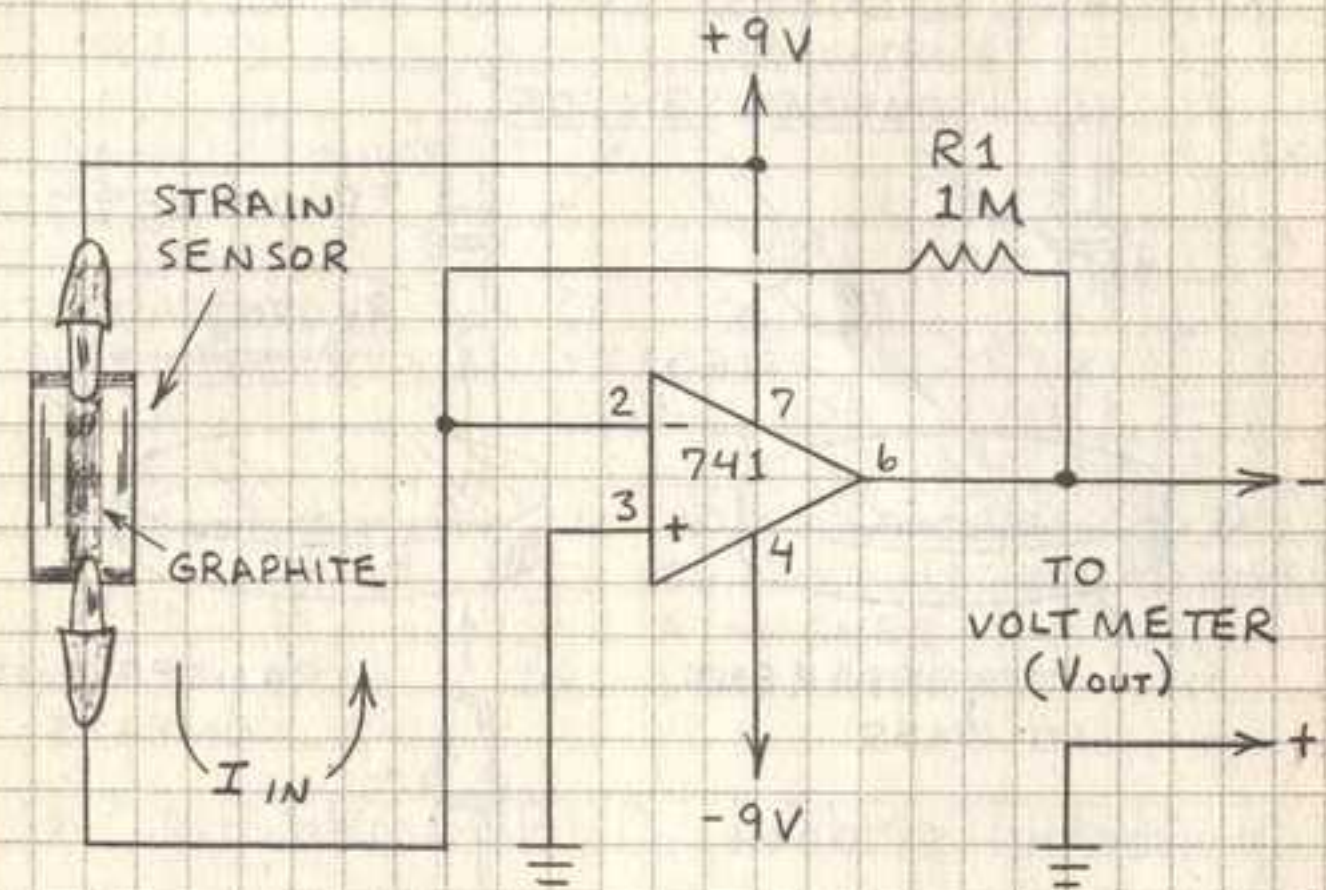

THIS CIRCUIT AMPLIFIES THE CURRENT THROUGH THE STRAIN SENSOR ( $I_{IN}$ ) BY 1,000,000. IT IS THEREFORE VERY SENSITIVE. REDUCE RESISTANCE OF  $R_1$  TO REDUCE GAIN ( $V_{out} = I_{IN} \times R_1$ ).

RESULTS WITH TYPICAL STRAIN SENSOR ( $V_{out}$ ):

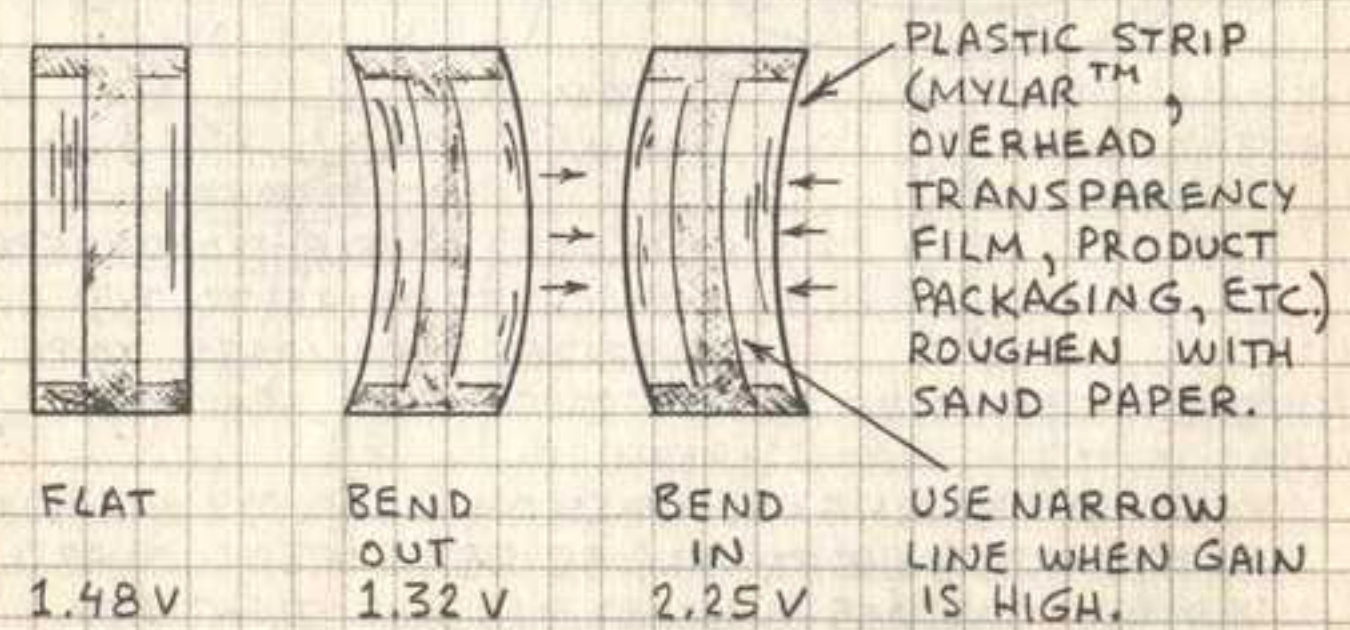

# MAGNETIC FIELD SENSOR

A COMPASS IS A MAGNETIC FIELD SENSOR. A LIGHT SENSOR CAN DETECT TINY MOVEMENTS OF A COMPASS NEEDLE CAUSED BY ELECTRIC MOTORS, MAGNETS AND SOLAR ACTIVITY.

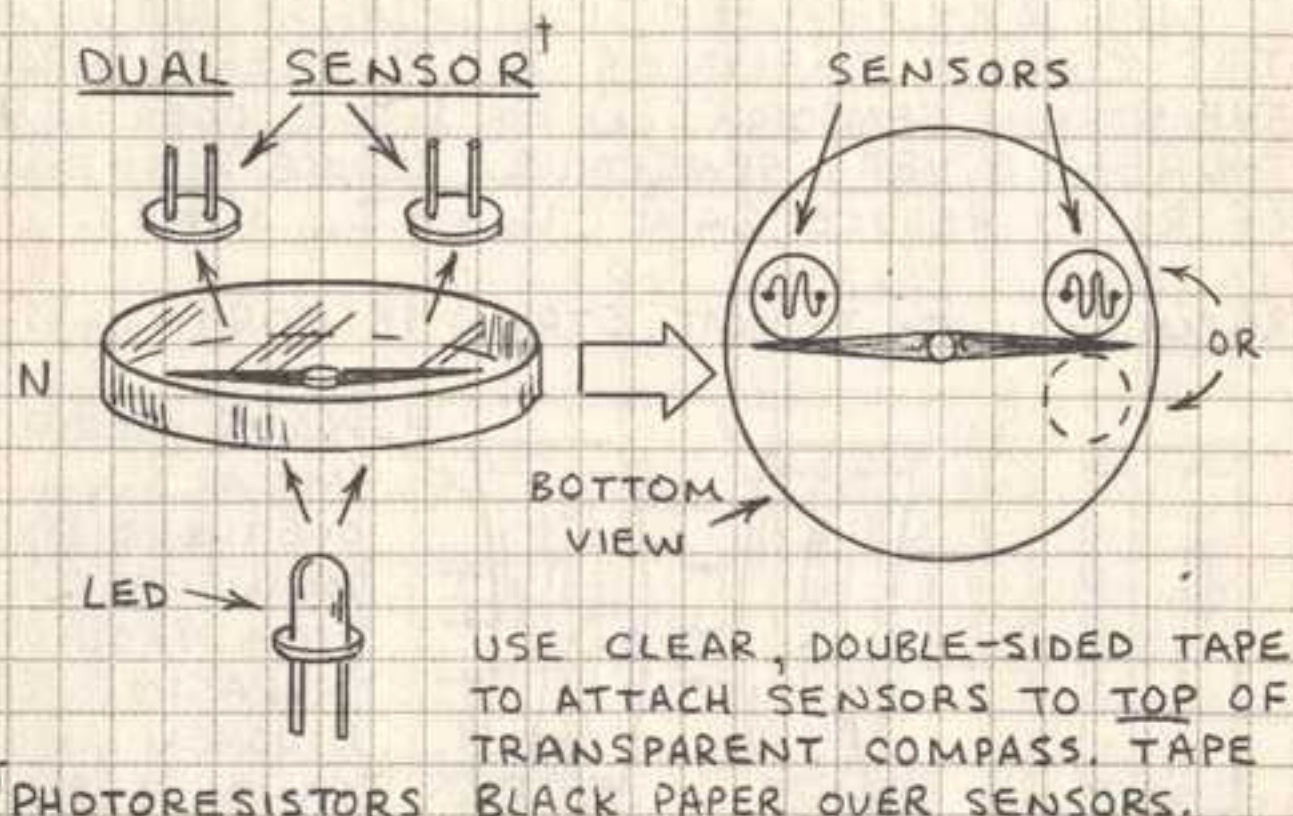
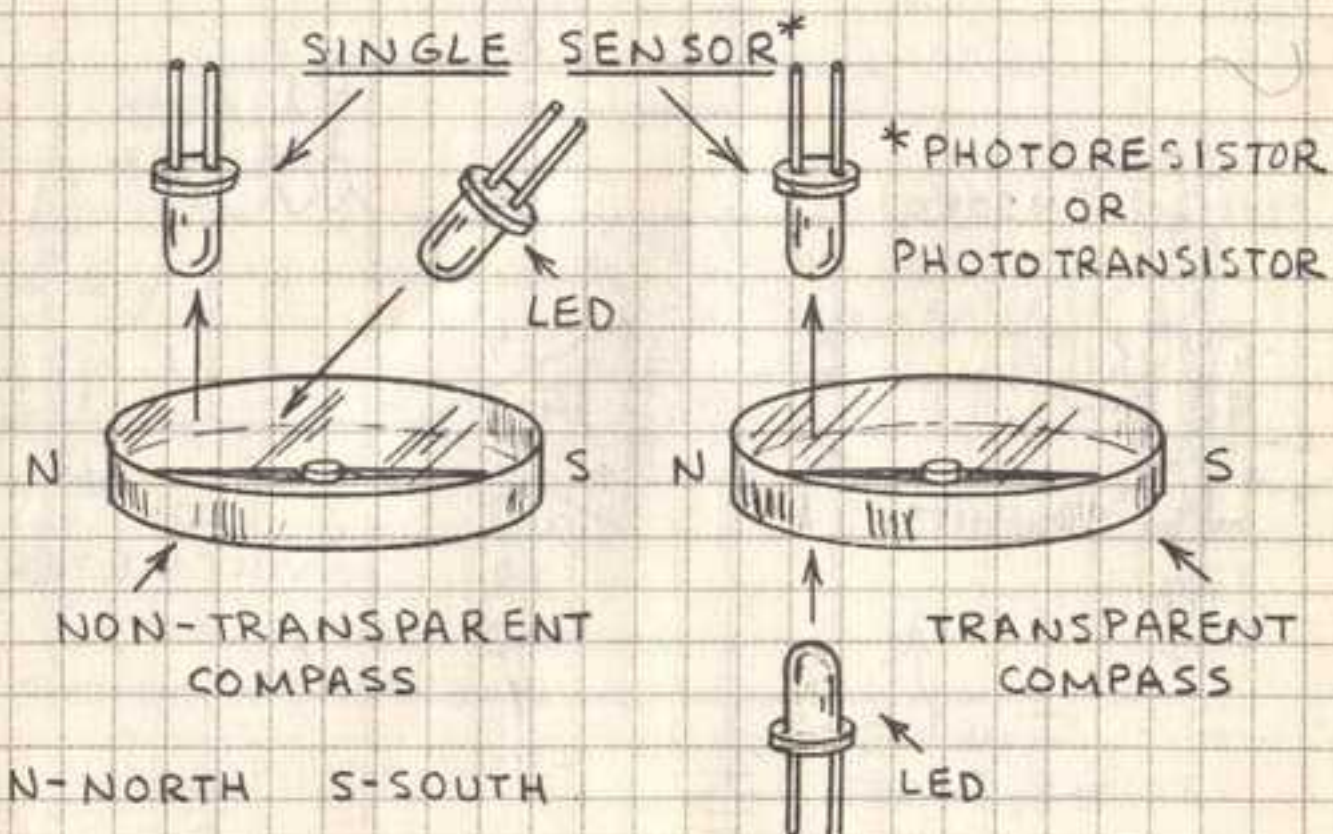

TEST BY PLACING COMPASS ON CLEAR BOX ON WHITE PAPER. ROOM LIGHT WILL BE REFLECTED UPWARD. INSTALL COMPASS AND LED IN LIGHT-TIGHT BOX.

# MAGNETIC FIELD SWITCH

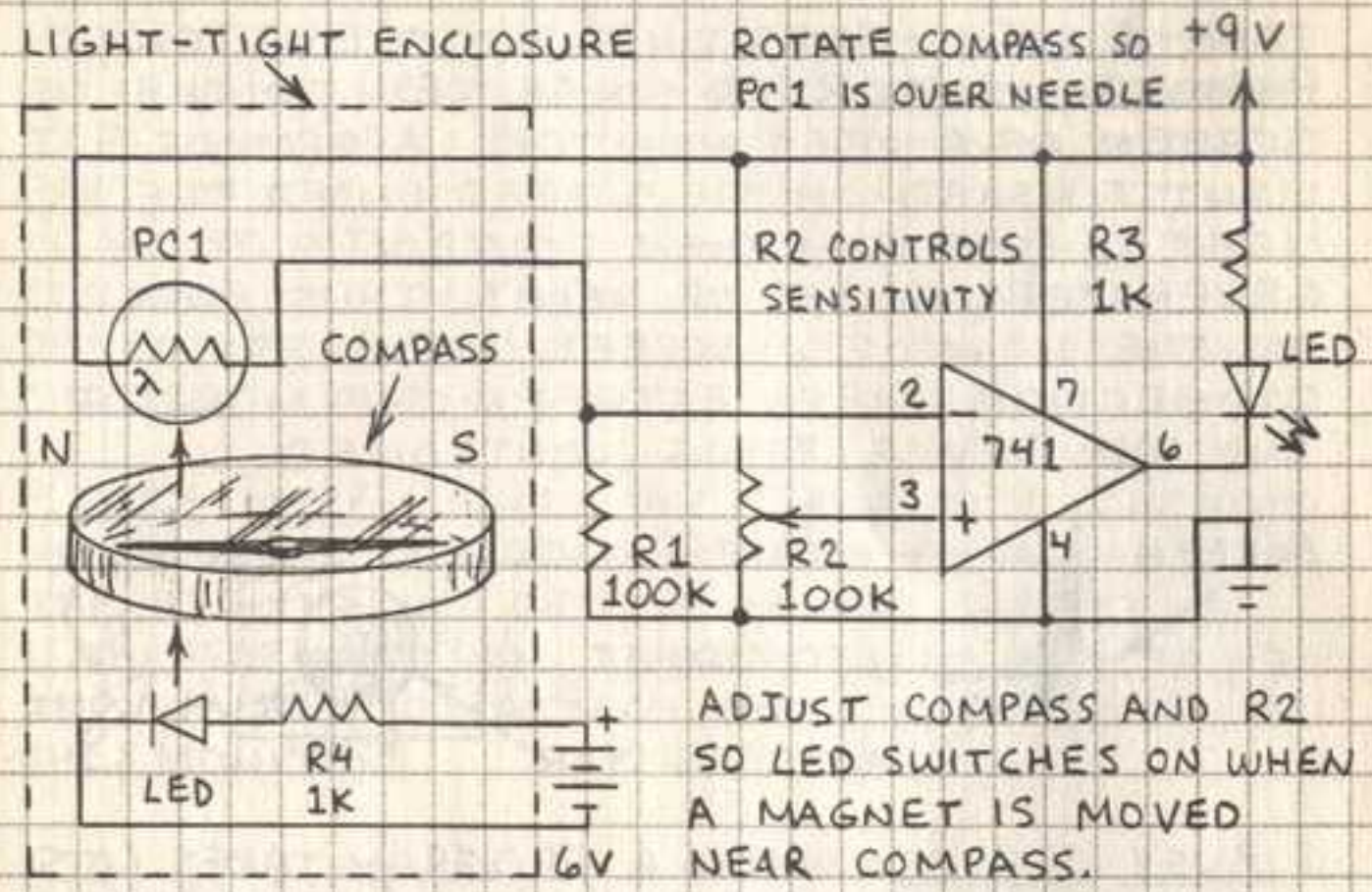

# MAGNETIC FIELD AMPLIFIER

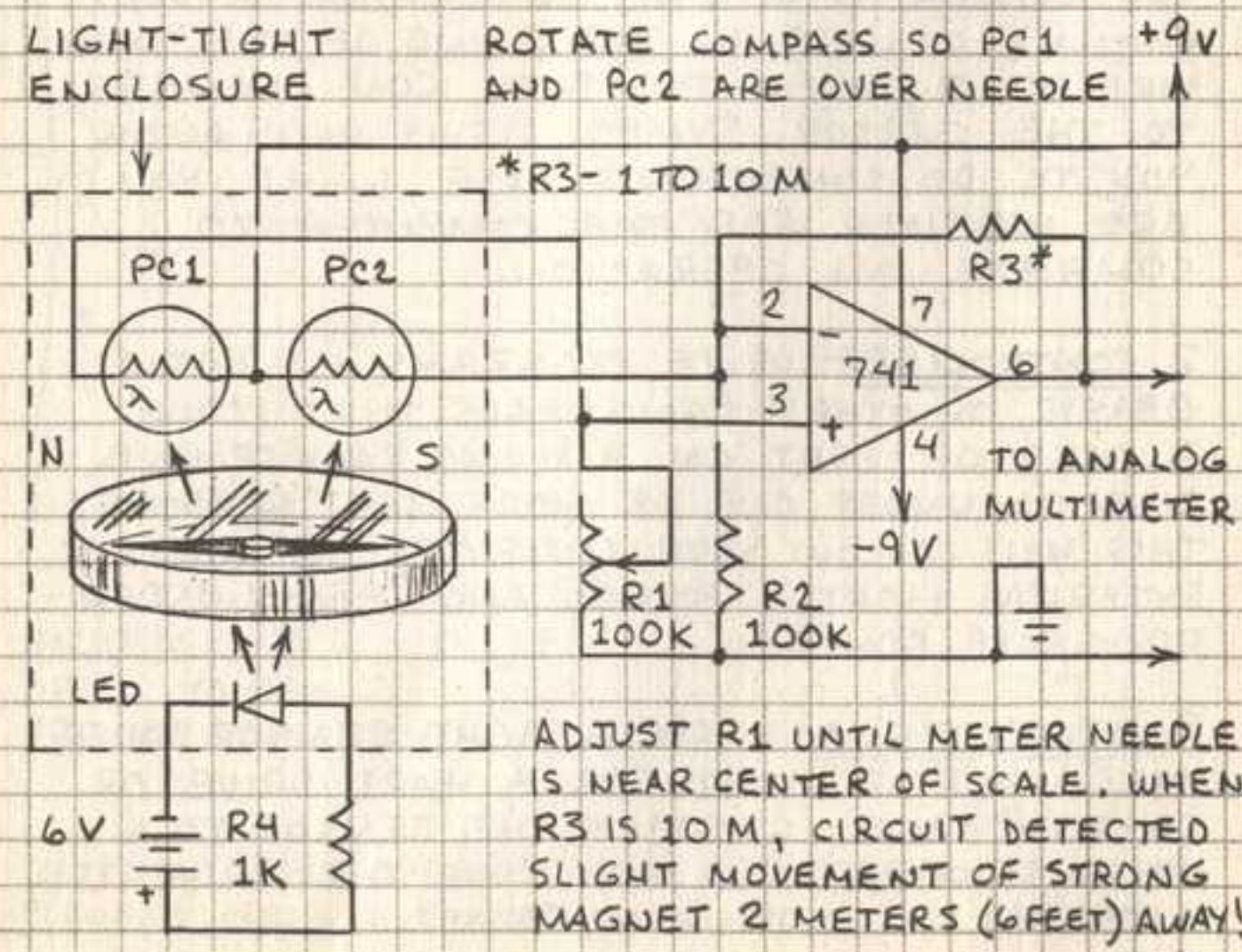

## VIDEO MONITOR SENSORS

TAPE A LIGHT-SENSITIVE PHOTORESISTOR, PHOTOTRANSISTOR OR SOLAR CELL TO THE SCREEN OF A VIDEO MONITOR. A SPOT OF LIGHT FLASHED ON THE SCREEN UNDER THE LIGHT SENSOR CAN THEN CONTROL A TONE GENERATOR, LIGHT OR RELAY. THUS LIGHT ON THE MONITOR'S SCREEN REPLACES CONNECTION WIRES BETWEEN THE MONITOR AND THE DEVICE BEING CONTROLLED.

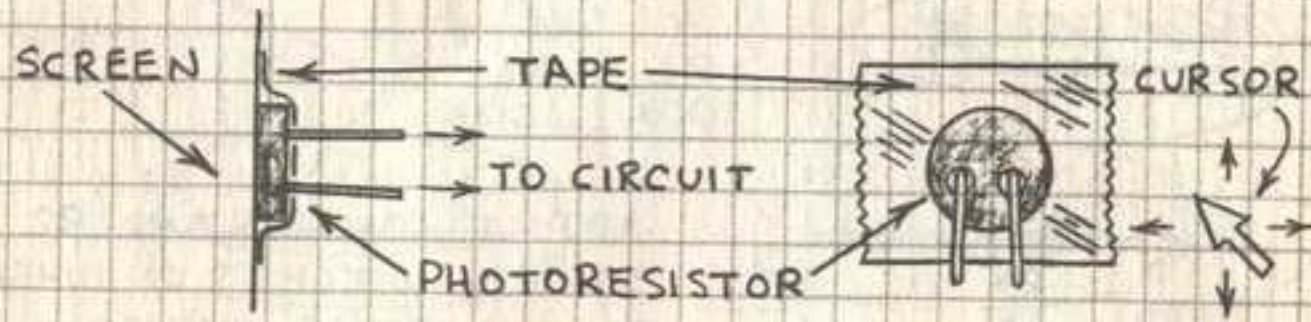

1. BUSY SIGNAL - WHEN A PROGRAM TAKES LOTS OF TIME TO CRUNCH DATA, USE THE MOUSE TO MOVE THE BUSY ICON (⌘) UNTIL IT IS UNDER A LIGHT SENSOR TAPED ON THE SCREEN. CONNECT THE SENSOR TO A TONE GENERATOR. A VERY DISTINCT CHANGE IN THE SOUND OF THE TONE WILL OCCUR WHEN THE BUSY ICON CHANGES TO THE CURSOR SYMBOL. THIS WILL ALLOW YOU TO DO SOMETHING ELSE WHILE YOU ARE WAITING FOR THE COMPUTER TO COMPLETE AN OPERATION.

2. CONTROLLER - WRITE PROGRAMS IN BASIC, QBASIC OR OTHER LANGUAGES THAT PLACE BLOCKS OF LIGHT ON A BLACK BACKGROUND DIRECTLY UNDER ONE OR MORE LIGHT SENSORS. THIS WILL ALLOW YOUR COMPUTER TO CONTROL EXTERNAL LIGHTS, SOUNDS AND RELAYS UNDER PROGRAM CONTROL.

3. DRIVE SIGNAL - TAPE A LIGHT SENSOR OVER THE INDICATOR LIGHT FOR A HARD DRIVE OR CD-ROM DRIVE. CONNECT THE SENSOR TO A TONE GENERATOR. EACH TIME THE DRIVE IS ACCESSED A TONE WILL SOUND.

34

4. VIDEO CAMERA - VIDEO CAMERAS ARE IDEAL FOR WATCHING A SLEEPING BABY OR A FRONT PORCH. BUT YOU MUST WATCH THE MONITOR TO KNOW WHEN SOMETHING HAS HAPPENED. TAPE ONE OR MORE LIGHT SENSORS TO THE PART OF THE SCREEN WHERE MOVEMENT OR CHANGES ARE MOST LIKELY TO OCCUR. THEN CONNECT THE SENSOR TO A THRESHOLD DETECTOR. WHEN THE IMAGE ON THE MONITOR CHANGES, A BUZZER WILL SOUND.

PLEASE NOTE - WHILE ALL THESE APPLICATIONS HAVE BEEN TESTED, THEY ARE EXPERIMENTAL. THE RESULTS YOU OBTAIN WILL BE SUBJECT TO INTERFERENCE FROM AMBIENT LIGHT AND TO HOW AND WHERE YOU ATTACH THE LIGHT SENSOR TO THE MONITOR.

## VIDEO MONITOR TONE GENERATOR

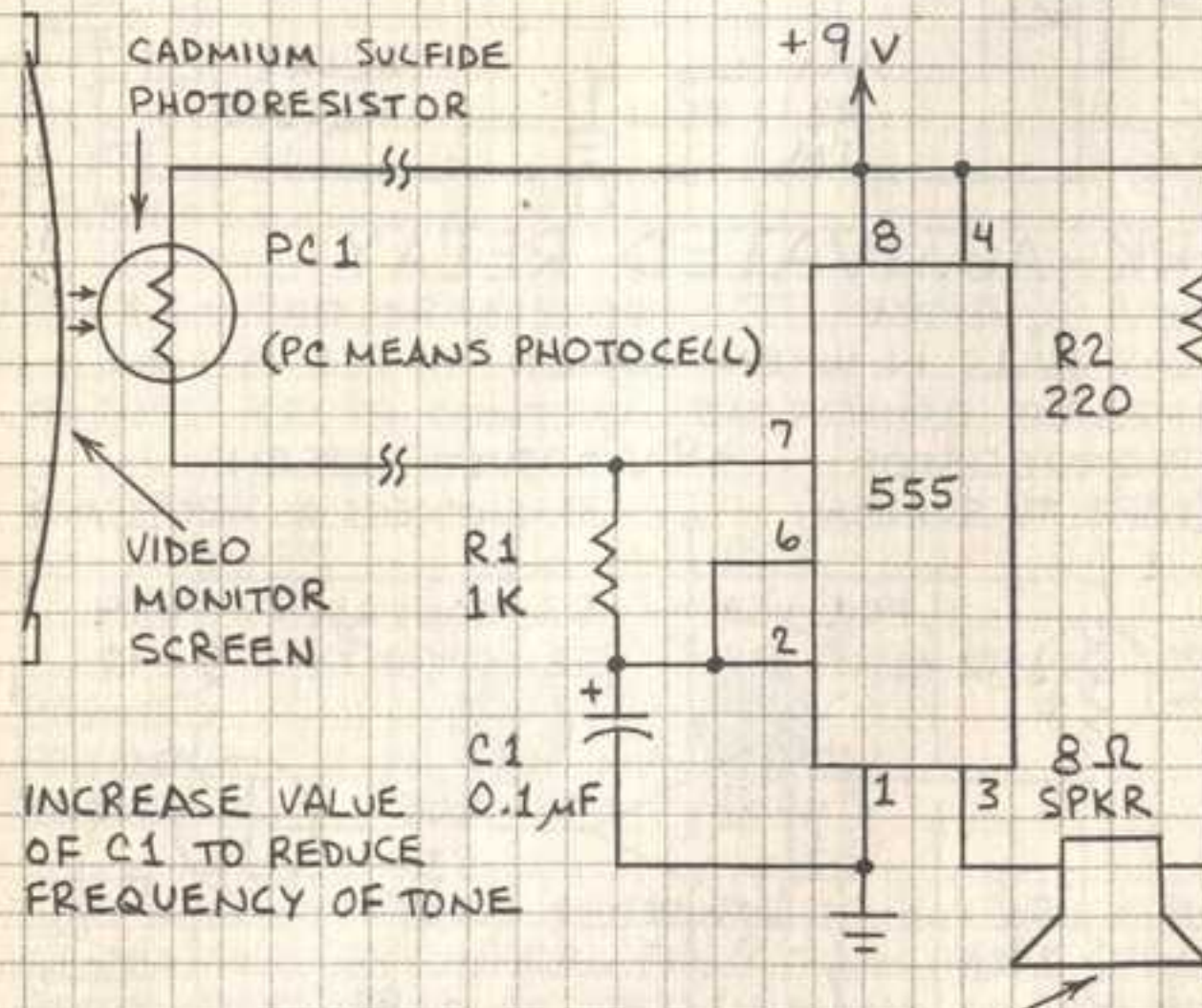

OK TO REPLACE SPEAKER WITH PIEZOELECTRIC BUZZER ELEMENT. (RED WIRE TO PIN 4 AND BLACK WIRE TO PIN 3.)

35

# VIDEO MONITOR RELAY CIRCUITS

THESE CIRCUITS PROVIDE A SIMPLE MEANS FOR CONTROLLING EXTERNAL DEVICES WITH A VIDEO MONITOR.

## LIGHT-ACTIVATED RELAY

RELAY DROPS OUT WHEN SCREEN AT PC1 IS BRIGHT.

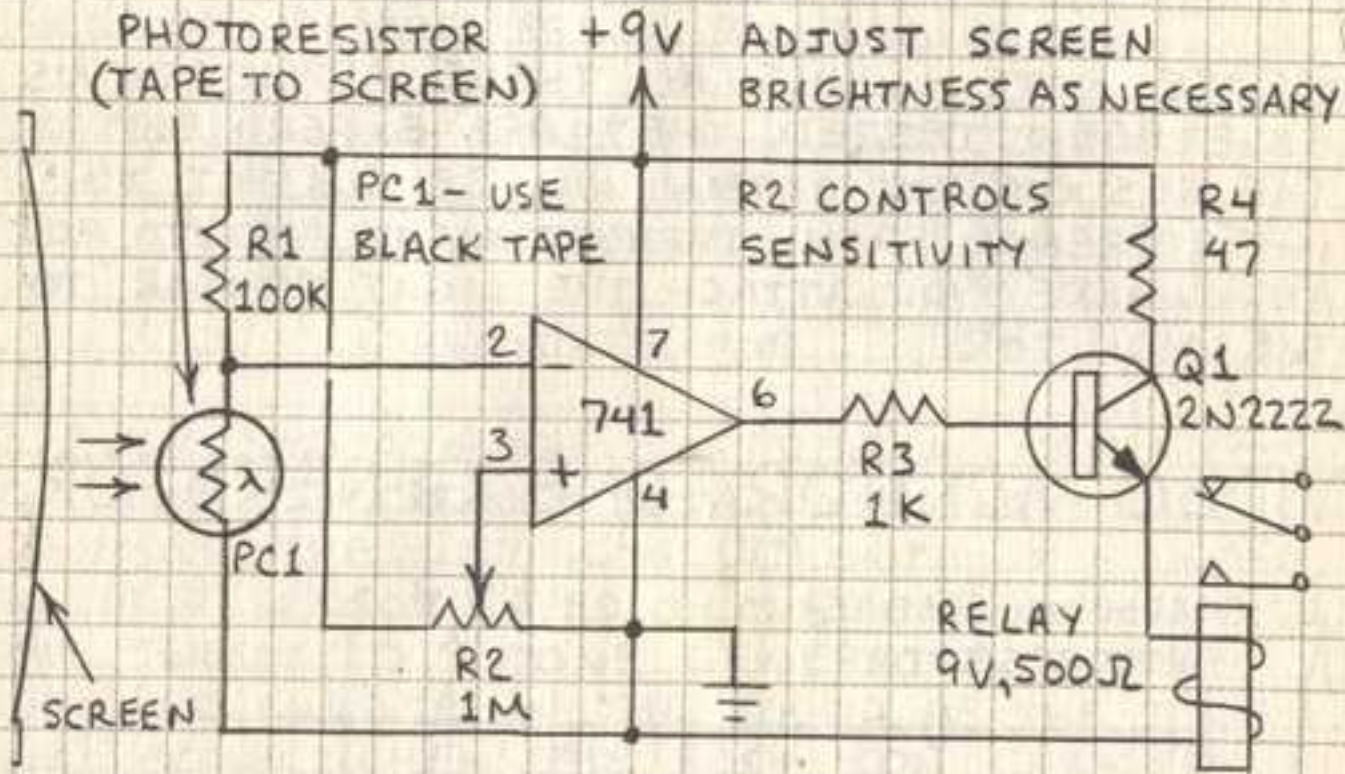

## DARK-ACTIVATED RELAY

RELAY PULLS IN WHEN SCREEN AT PC1 IS DARK.

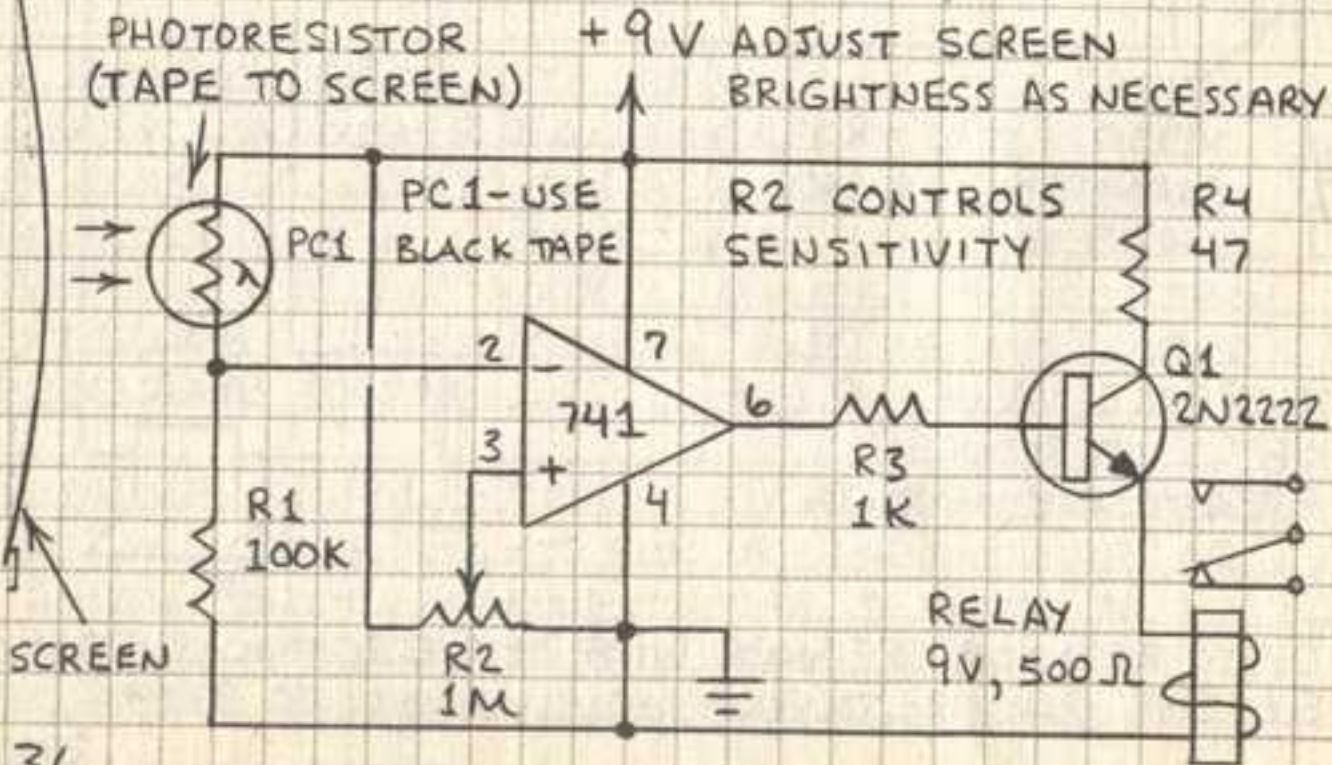

36

# IMPROVED VIDEO MONITOR RELAY

THIS CIRCUIT USES DUAL PHOTORESISTORS TO PROVIDE DIFFERENTIAL OPERATION. CHANGES IN ROOM LIGHTING CAUSE THE SAME RESISTANCE CHANGE IN BOTH PHOTORESISTORS, THUS THEY CANCEL ONE ANOTHER. ONLY WHEN PC1 RECEIVES MORE LIGHT THAN PC2 IS THE CIRCUIT UNBALANCED AND THE RELAY ACTUATED.

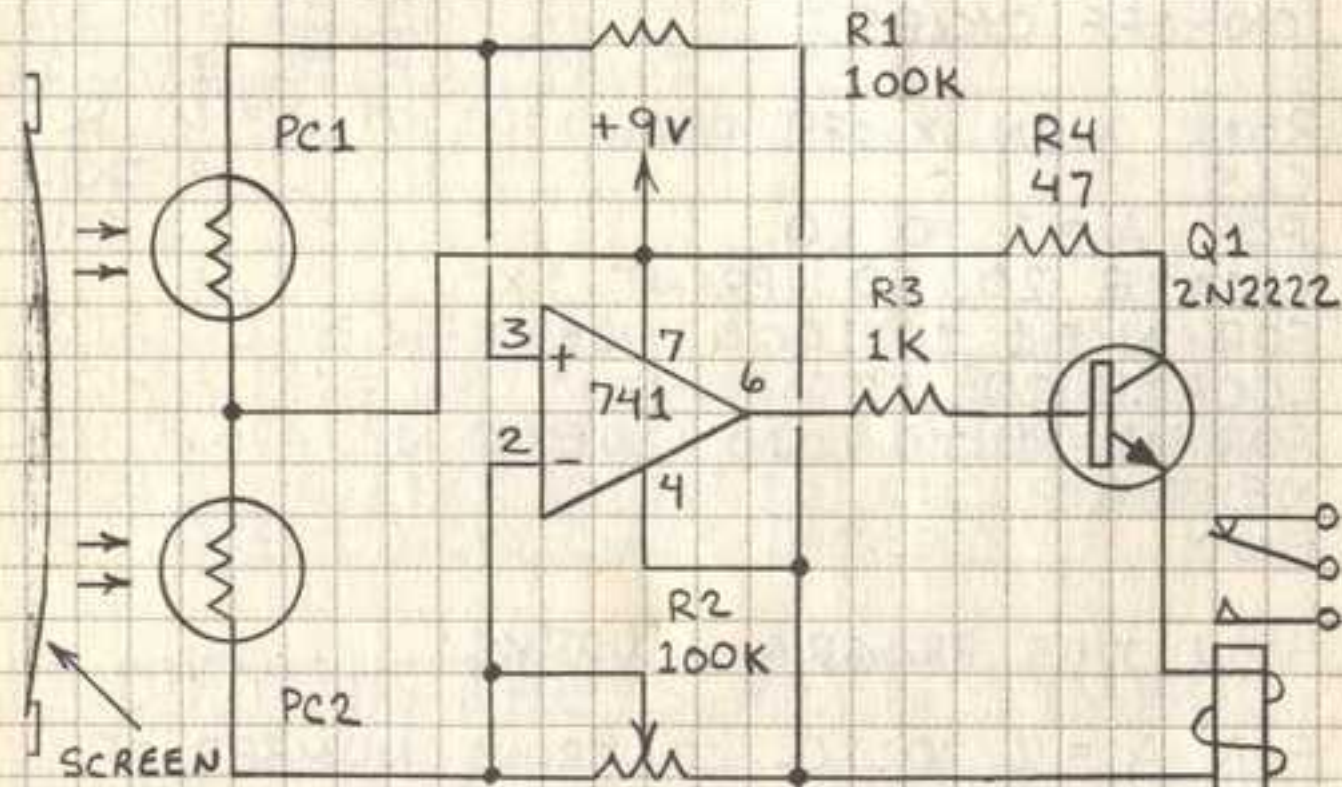

PC1 & 2 - PHOTORESISTORS = 500Ω, 9 VOLT

ADJUST R2 TO CONTROL SWITCHING THRESHOLD.

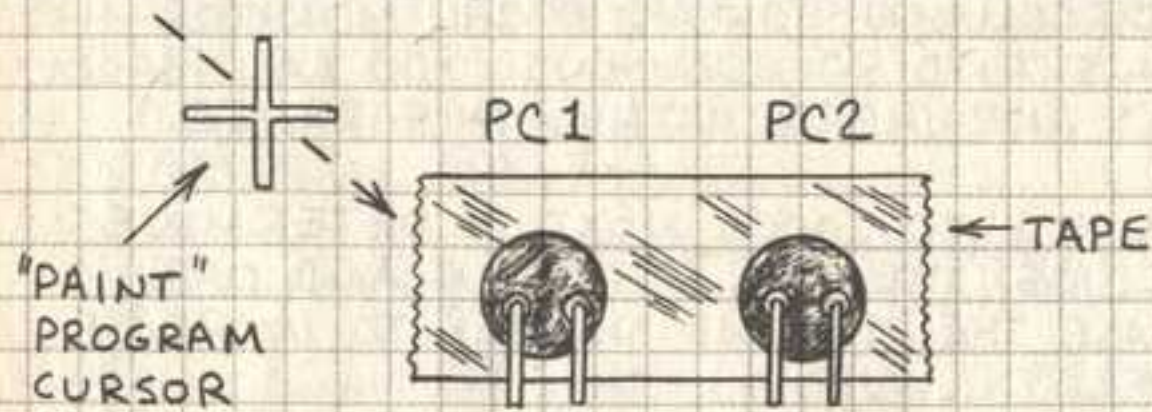

THIS CIRCUIT EASILY RESPONDS TO VARIOUS CURSORS GENERATED BY TYPICAL PAINT PROGRAMS. THE PROTOTYPE COULD BE SET (VIA R2) TO ACTUATE THE RELAY WHEN THE TEXT CURSOR IN MICROSOFT™ PAINTBRUSH APPROACHED PC1 (WHITE ON BLACK).

37

## VIDEO MONITOR SENSOR PROGRAMS

HERE ARE SOME SIMPLE PROGRAMS THAT DEMONSTRATE HOW A COMPUTER CAN CONTROL EXTERNAL DEVICES VIA ONE OR MORE LIGHT SENSORS THAT RECEIVE PROGRAMMED FLASHES OF LIGHT FROM THE MONITOR'S SCREEN.

THIS BASIC PROGRAM PLACES AN "X" AT THE SAME PLACE ON THE SCREEN FOR 10 ON-OFF CYCLES:

```
REM X ON X OFF DEMO
CLS
FOR A = 1 TO 10
LOCATE 20, 50: PRINT "X"
FOR N = 1 TO 1000: NEXT N
LOCATE 20, 50: PRINT " "
FOR N = 1 TO 1000: NEXT N
NEXT A
END
```

HOW THIS PROGRAM WORKS:

FOR A = 1 TO 10 CONTROLS NUMBER OF ON-OFF CYCLES. FOR EXAMPLE, CHANGE 10 TO 100 FOR 100 CYCLES.

LOCATE 20, 50: PRINT "X" PLACES AN "X" AT ROW 20, COLUMN 50. A TYPICAL MONITOR HAS 25 ROWS AND 80 COLUMNS. YOU CAN PLACE THE "X" ANYWHERE WITHIN THIS RANGE.

FOR N = 1 TO 1000: NEXT N DETERMINES HOW LONG THE "X" STAYS ON AND OFF. INCREASE THE SECOND NUMBER TO INCREASE THE DELAY.

FOR FLASHING CURSOR, CHANGE LOCATE STATEMENTS:

```
LOCATE 20, 50, 1, 0, 7 (CURSOR ON)
:
LOCATE 20, 50, 1, 1, 0 (CURSOR OFF)
38
```

THIS PROGRAM ALTERNATELY FLASHES AN "X" AT TWO ADJACENT LOCATIONS TO CONTROL TWO LIGHT SENSORS.

```
REM DUAL FLASHER ROUTINE
CLS
FOR A = 1 TO 10
LOCATE 20, 50: PRINT "X"
LOCATE 20, 40: PRINT " "
FOR N = 1 TO 1000: NEXT N
LOCATE 20, 50: PRINT " "
LOCATE 20, 40: PRINT "X"
FOR N = 1 TO 1000: NEXT N
NEXT A
END
```

NOTE: THIS PROGRAM AND THE ONE ON FACING PAGE WILL WORK WITH BASIC IF YOU PLACE A CONSECUTIVE NUMBER BEFORE EACH LINE. (TRY 10, 20, 30, ETC. SO YOU CAN INSERT NEW LINES LATER.)

## MODIFYING THE SCREEN SYMBOL

LOCATE IS THE SIMPLEST COMMAND FOR PLACING A CHARACTER AT A DESIRED PLACE ON THE SCREEN. IF "X" OR OTHER KEYBOARD CHARACTERS DO NOT PROVIDE ENOUGH LIGHT OR CONTRAST TO ACTIVATE YOUR SENSOR, INCREASE THE SCREEN BRIGHTNESS OR TRY USING AN ASCII CHARACTER ACCESSED BY THE CHR\$ STATEMENT. FOR EXAMPLE:

```
LOCATE 20, 20: PRINT CHR$(178)
```

PLACES A WHITE BOX ON THE SCREEN. OTHER SUITABLE ASCII SYMBOLS INCLUDE:

□ - 176	- 179	≠ - 216	□ - 220	o - 249
□ - 177	+ - 197	□ - 219	□ - 223	• - 250

SEE PROGRAM MANUALS FOR COMPLETE LIST.

# LIGHTNING SENSOR

USE THIS CIRCUIT TO DETECT DISTANT FLASHES OF LIGHTNING.

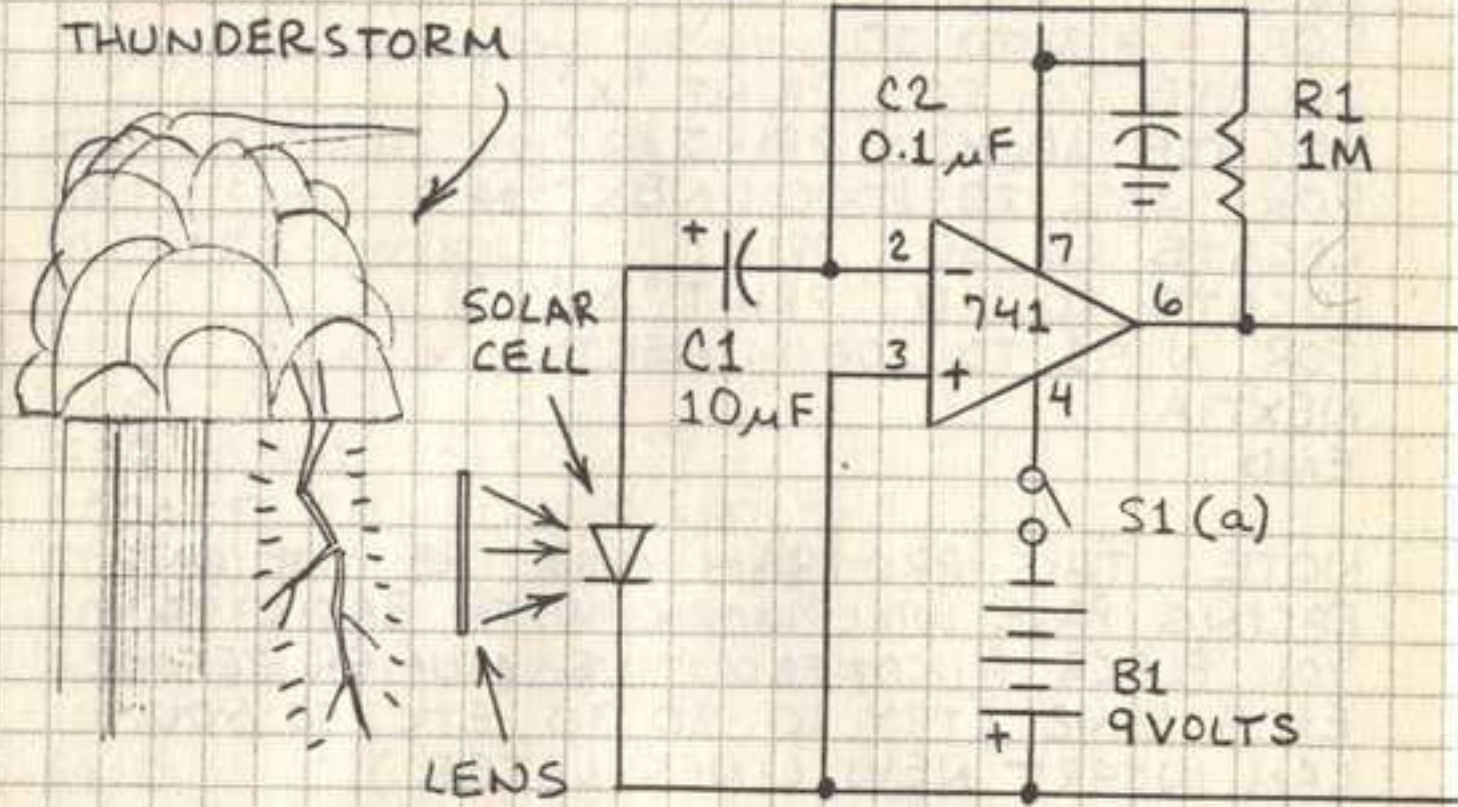

SINCE A LIGHTNING BOLT IS A GIANT RADIO TRANSMITTER, A TRANSISTOR RADIO CAN DETECT LIGHTNING. BUT THE POPS AND CRACKLES YOU HEAR DO NOT REVEAL THE DIRECTION OF THE LIGHTNING. THIS CIRCUIT INDICATES THE GENERAL DIRECTION OF LIGHTNING BOLTS DURING THE DAY WHEN IT MAY BE TOO BRIGHT TO SEE THE FLASHES. AT NIGHT IT WILL DETECT DISTANT LIGHTNING THAT MAY BE TOO FAINT TO SEE.

FOR BEST RESULTS MOUNT THE SOLAR CELL BEHIND A MAGNIFYING LENS. A LARGE PLASTIC FRESNEL LENS SUCH AS THE FLAT PLASTIC LENSES SOLD AS PAGE MAGNIFIERS WORKS WELL. THE LENS WILL COLLECT MUCH MORE LIGHT THAN THE SOLAR CELL ALONE AND IT WILL MAKE THE SENSOR VERY DIRECTIONAL.

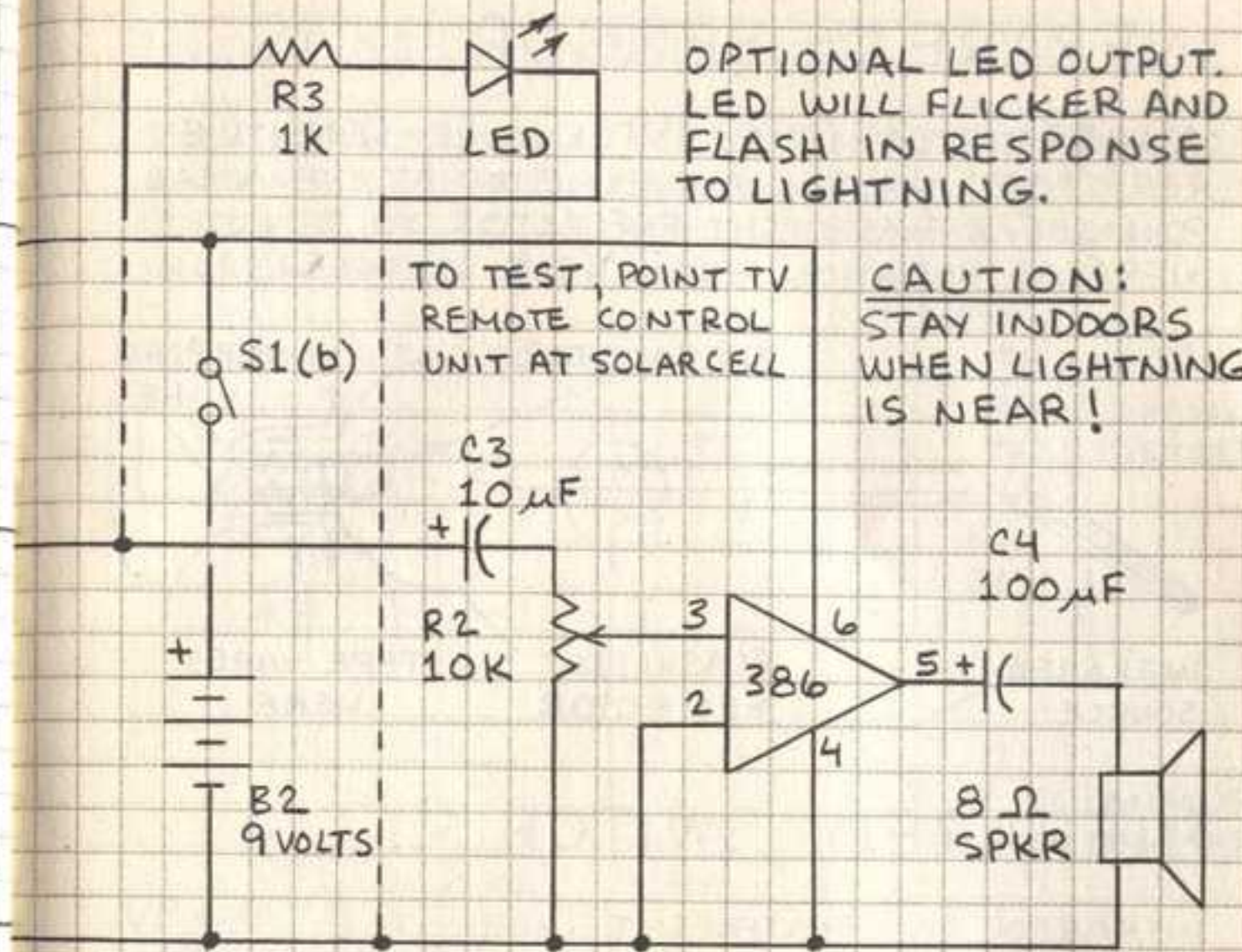

OPTIONAL LED OUTPUT. LED WILL FLICKER AND FLASH IN RESPONSE TO LIGHTNING.

TO TEST, POINT TV REMOTE CONTROL UNIT AT SOLARCELL

**CAUTION!**  
STAY INDOORS  
WHEN LIGHTNING  
IS NEAR!

TO MAKE A DIRECTIONAL LIGHTNING SENSOR, CEMENT A SOLAR CELL TO THE INSIDE OF EACH SIDE OF A CLEAR SQUARE PLASTIC BOX. ASSEMBLE FOUR SENSOR CIRCUITS WITH AN LED OUTPUT (LESS 386 AUDIO OUTPUT STAGE) ON A CIRCUIT BOARD AND INSTALL BOARD AND BATTERY INSIDE THE PLASTIC BOX. SELECT A DIFFERENT COLOR (RED, YELLOW, ORANGE AND GREEN) FOR EACH LED. INSTALL THE LEDS ON THE SAME SIDE OF THE BOX SO THEY CAN BE SEEN FROM A DISTANCE. MARK EACH SIDE OF THE BOX WITH THE FOUR COMPASS DIRECTIONS (NORTH, EAST, SOUTH AND WEST) AND NOTE THE LED COLOR FOR EACH DIRECTION. PLACE THE SENSOR IN AN OPEN FIELD SO THAT ITS NORTH SIDE FACES NORTH AND WHERE YOU CAN SEE IT FROM INSIDE YOUR HOUSE. COLOR OF FLASHING LED OR LEDS WILL INDICATE THE APPROXIMATE DIRECTION OF LIGHTNING BOLTS.

## INFRARED SENSOR

A THERMISTOR IS A TEMPERATURE-SENSITIVE RESISTOR. INSTALL A THERMISTOR AT THE FOCAL POINT OF A FLASHLIGHT REFLECTOR TO DETECT INFRARED RADIATION FROM HEAT SOURCES.

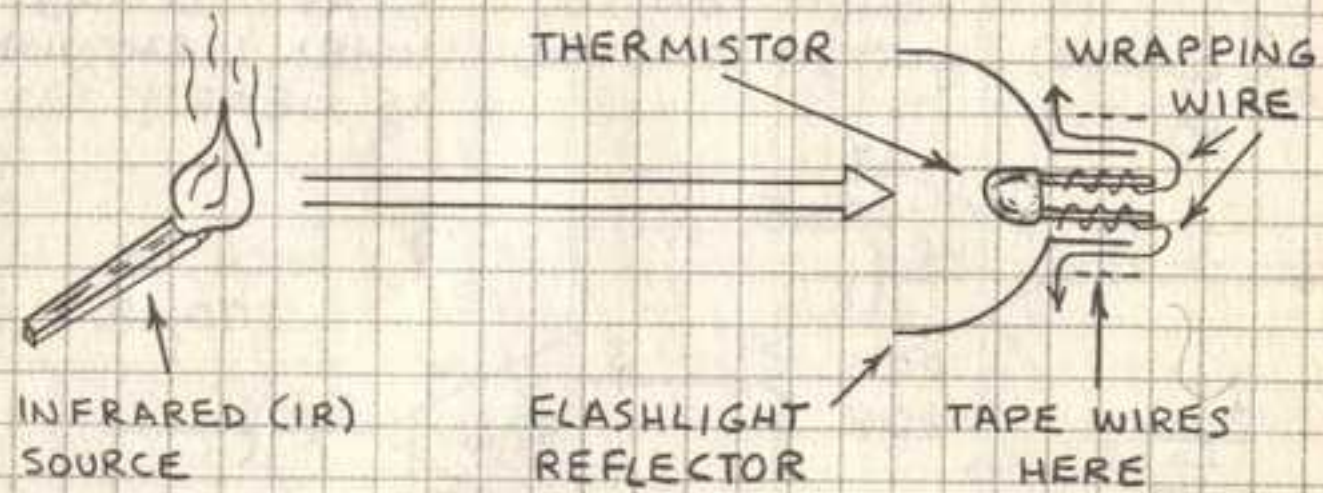

## INFRARED SWITCH

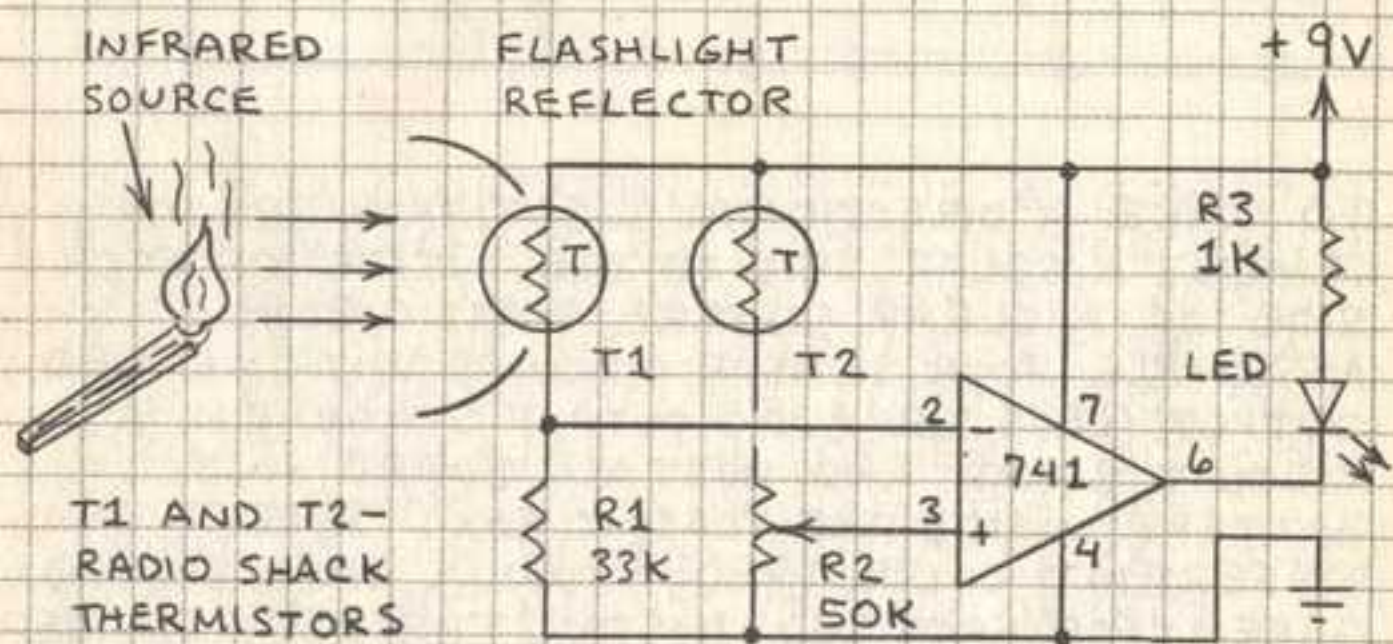

CONNECT BATTERY AND WAIT SEVERAL SECONDS TO ALLOW THERMISTORS TO STABILIZE. ADJUST R2 UNTIL LED JUST SWITCHES OFF. PLACE YOUR HAND NEAR REFLECTOR AND LED SHOULD TURN ON. A MATCH WILL TRIGGER THE CIRCUIT FROM UP TO 1 METER (ABOUT 3 FEET) OR MORE. NOTE THAT CHANGES IN AIR TEMPERATURE CAUSE EQUAL CHANGES IN T1 AND T2. BUT AN INFRARED SOURCE AFFECTS ONLY T1. TO ADD RELAY SEE SIMILAR CIRCUITS IN THIS BOOK.

42

## INFRARED AMPLIFIER

THIS CIRCUIT WILL INDICATE THE PRESENCE OF A FLAME OR HOT SOLDERING IRON. THE OUTPUT VOLTAGE ( $V_{out}$ ) INCREASES AS INFRARED INCREASES.

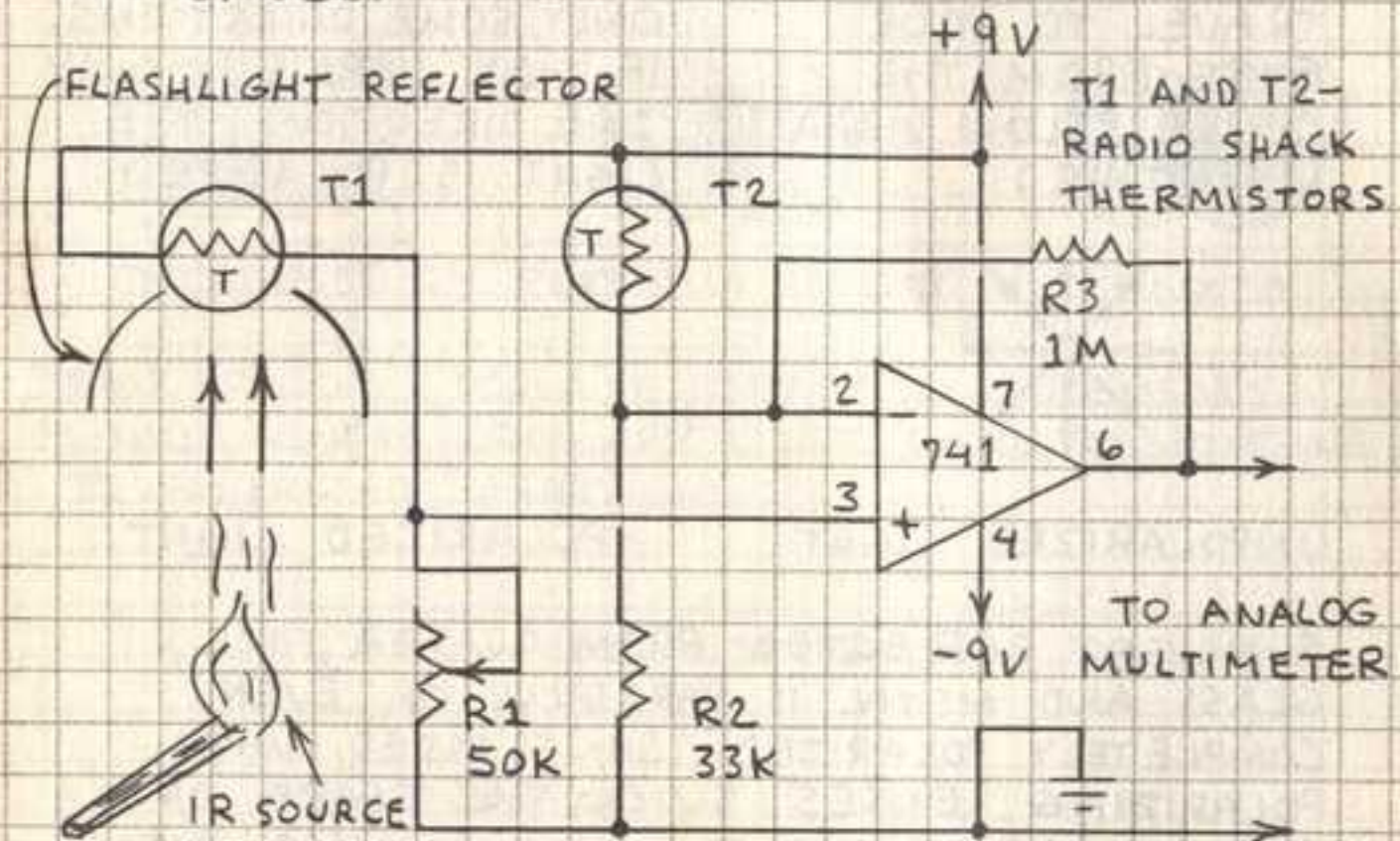

SET MULTIMETER TO 0-5 OR 0-10 VOLTS DC. ADJUST R1 UNTIL METER NEEDLE IS NEAR CENTER OF METER SCALE. AN INFRARED SOURCE WITHIN FIELD OF VIEW OF REFLECTOR WILL CAUSE THE METER NEEDLE TO DEFLECT UPWARD (TO RIGHT). REMOVE IR SOURCE AND THE METER NEEDLE WILL MOVE DOWNWARD (TO LEFT). CORRECT ALIGNMENT OF T1 INSIDE THE REFLECTOR IS IMPORTANT.

## REFLECTOR ALIGNMENT

THERMISTOR MUST BE AT REFLECTOR FOCAL POINT. THE FOCAL POINT IS WHERE FILAMENT OF FLASHLIGHT BULB WOULD BE. LOOK INTO REFLECTOR AND SEE

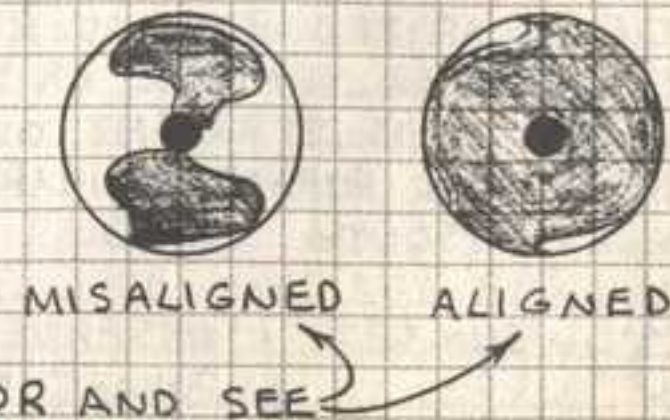

43

# POLARIZED LIGHT

WAVES OF ORDINARY LIGHT VIBRATE IN MANY DIRECTIONS. LIGHT WAVES THAT TRAVEL TO YOUR EYES FROM THE CIRCLE BELOW VIBRATE LIKE THIS:



UNPOLARIZED LIGHT

RAY OF REFLECTED LIGHT AND LIGHT THAT PASSES THROUGH SOME MATERIALS VIBRATE IN ONLY SOME DIRECTIONS. IF THEY VIBRATE IN ONLY ONE DIRECTION, THE LIGHT IS POLARIZED:



POLARIZED LIGHT

SUNLIGHT REFLECTED FROM WATER, ICE, GLASS AND METAL IS PARTIALLY OR EVEN COMPLETELY POLARIZED. SUNGLASSES WITH POLARIZING LENSES BLOCK THE GLARE OF REFLECTED SUNLIGHT, WHICH MAKES THEM POPULAR WITH PEOPLE WHO FISH OR SKI. THE SKY 90° AWAY FROM THE SUN IS PARTIALLY POLARIZED. YOU CAN SEE THIS YOURSELF WITH THE HELP OF POLARIZED SUNGLASSES.

THE MOST POLARIZED SECTION OF THE SKY APPEARS AS A DARK BAND WHEN VIEWED THROUGH POLARIZED SUNGLASSES. WITH YOUR BACK TO THE SUN, LOOK AT THE SKY 90° AWAY FROM THE SUN TO SEE THIS: THE POLARIZED BAND IS BEST SEEN NEAR SUNRISE OR SUNSET WHEN IT IS STRAIGHT OVER HEAD AND FORMS A NEARLY NORTH-SOUTH BAND.

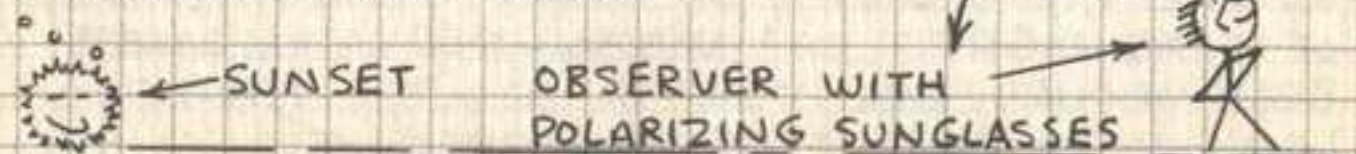

# POLARIZED LIGHT SENSOR

POLARIZING FILTERS ARE AVAILABLE FROM CAMERA AND SCIENCE STORES, OR USE LENSES FROM INEXPENSIVE POLARIZING SUNGLASSES. CROSSING TWO POLARIZERS BLOCKS MOST LIGHT.

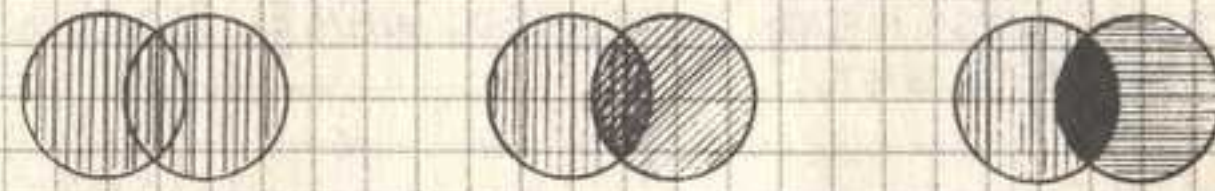

UNCROSSED PARTIALLY CROSSED CROSSED

THIS PRINCIPLE CAN BE USED TO MAKE SENSORS WHICH IGNORE ORDINARY LIGHT WHILE RESPONDING TO POLARIZED LIGHT.

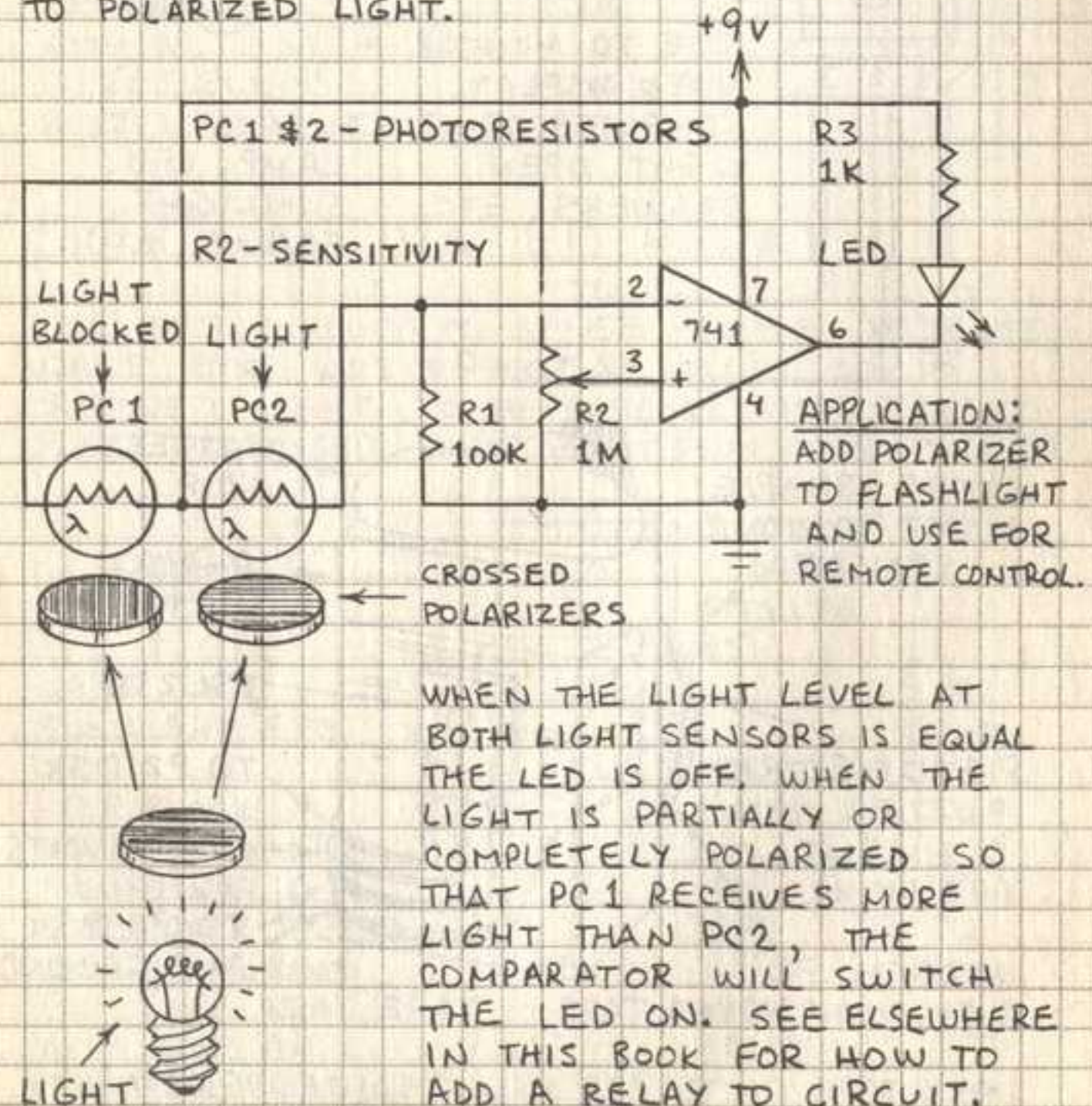

WHEN THE LIGHT LEVEL AT BOTH LIGHT SENSORS IS EQUAL THE LED IS OFF, WHEN THE LIGHT IS PARTIALLY OR COMPLETELY POLARIZED SO THAT PC1 RECEIVES MORE LIGHT THAN PC2, THE COMPARATOR WILL SWITCH THE LED ON. SEE ELSEWHERE IN THIS BOOK FOR HOW TO ADD A RELAY TO CIRCUIT.



# INTEGRATED LIGHT SENSORS

INTEGRATED LIGHT SENSORS COMBINE A LIGHT-SENSITIVE PHOTODIODE AND AMPLIFIER OR OSCILLATOR IN A MINIATURE PACKAGE WITH A BUILT-IN WINDOW OR LENS. SOME ARE ENCAPSULATED IN DYED PLASTIC THAT TRANSMITS NEAR INFRARED WHILE BLOCKING VISIBLE LIGHT.

## LIGHT-TO-TONE SENSOR

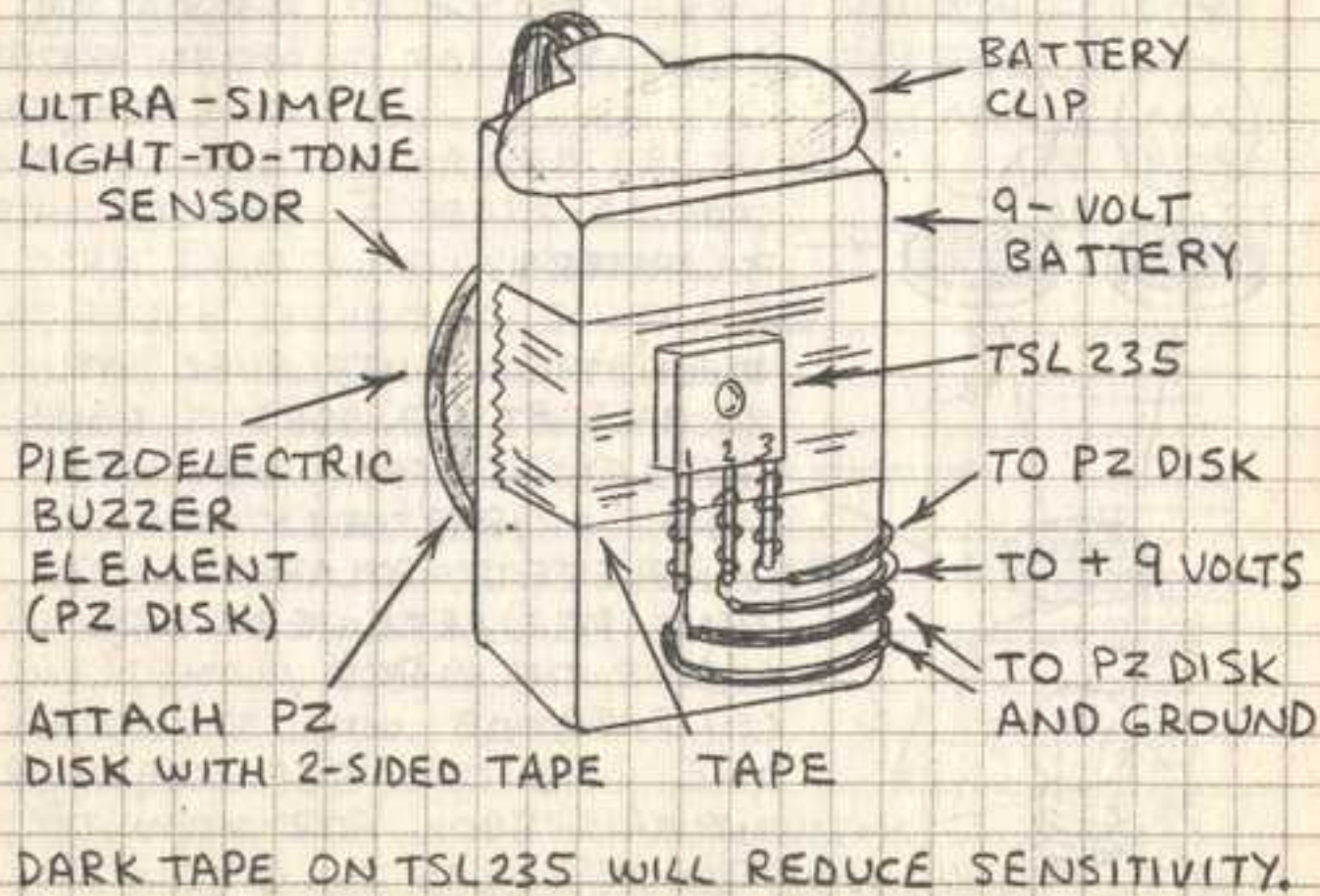
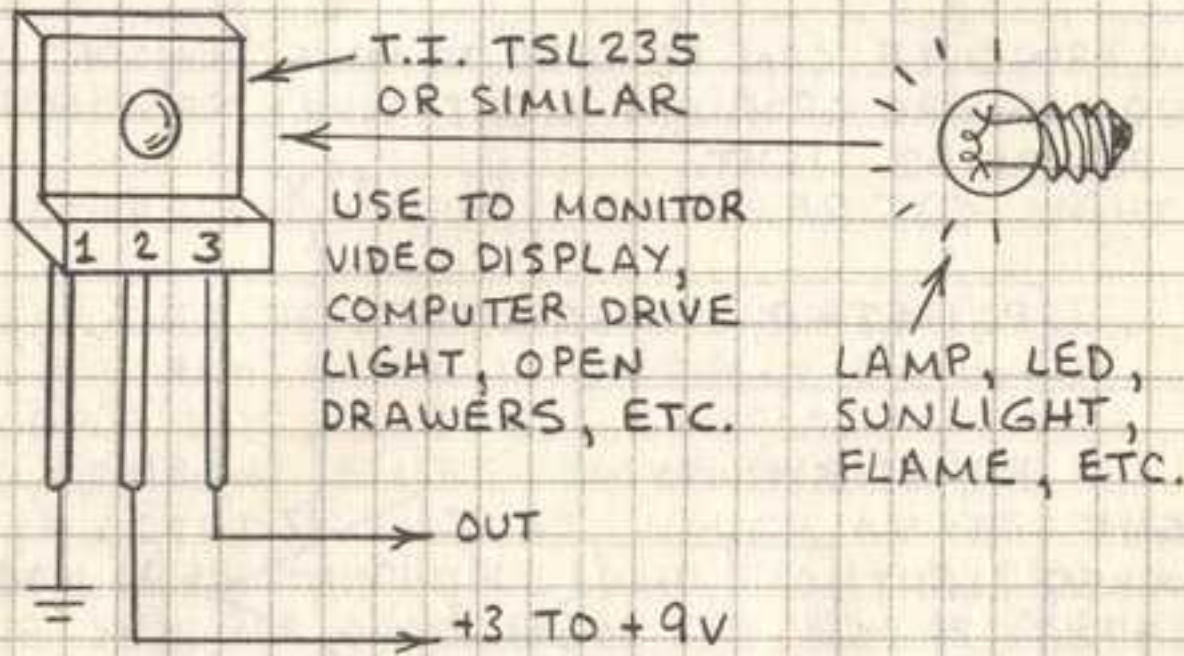

46

# IR REMOTE CONTROL SENSOR

LED WILL GLOW OR PULSATE IF IR REMOTE CONTROL TRANSMITTER IS TRANSMITTING.

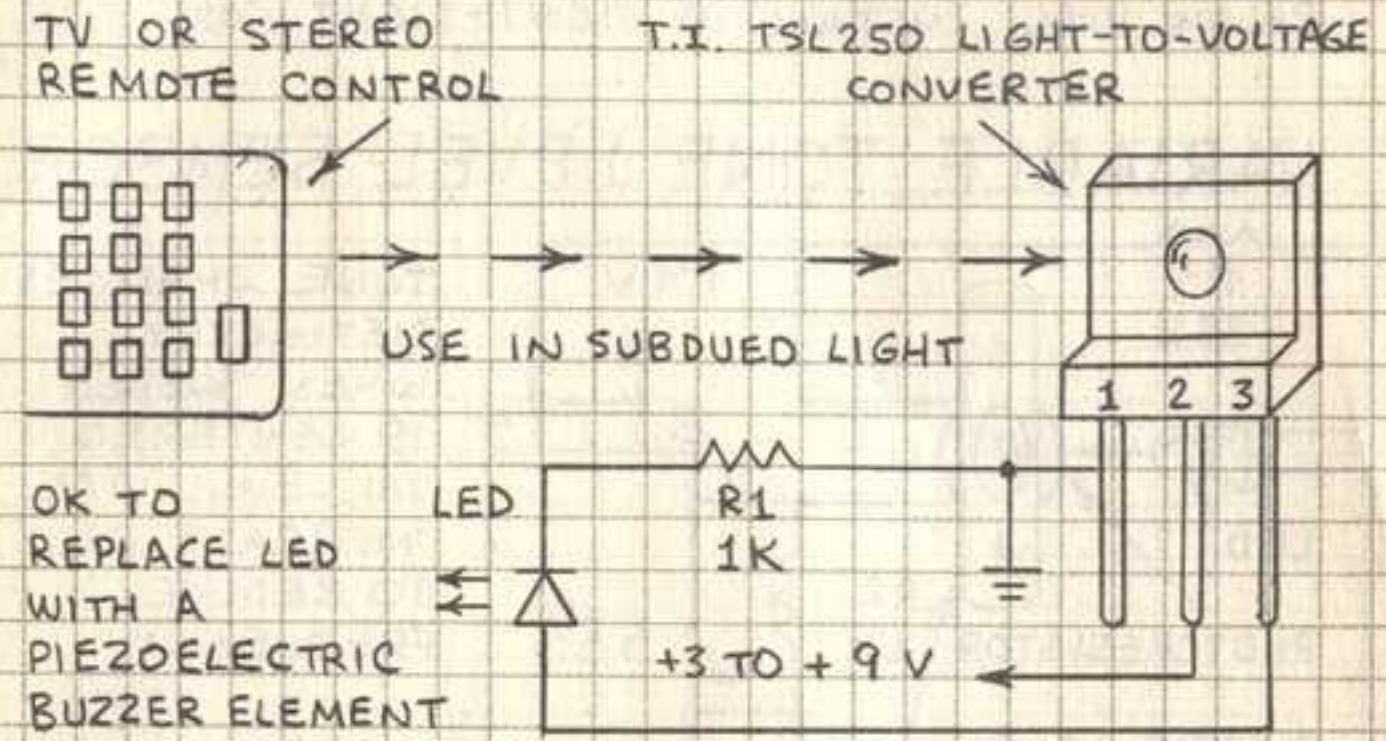

## LIGHT-ACTIVATED RELAY

USE THIS CIRCUIT TO SENSE PEOPLE, OBJECTS, CARS, ETC. WORKS BEST AT NIGHT OR IN SUBDUED LIGHT. TO HELP BLOCK VISIBLE LIGHT PLACE PROCESSED COLOR PRINT FILM OVER TSL250.

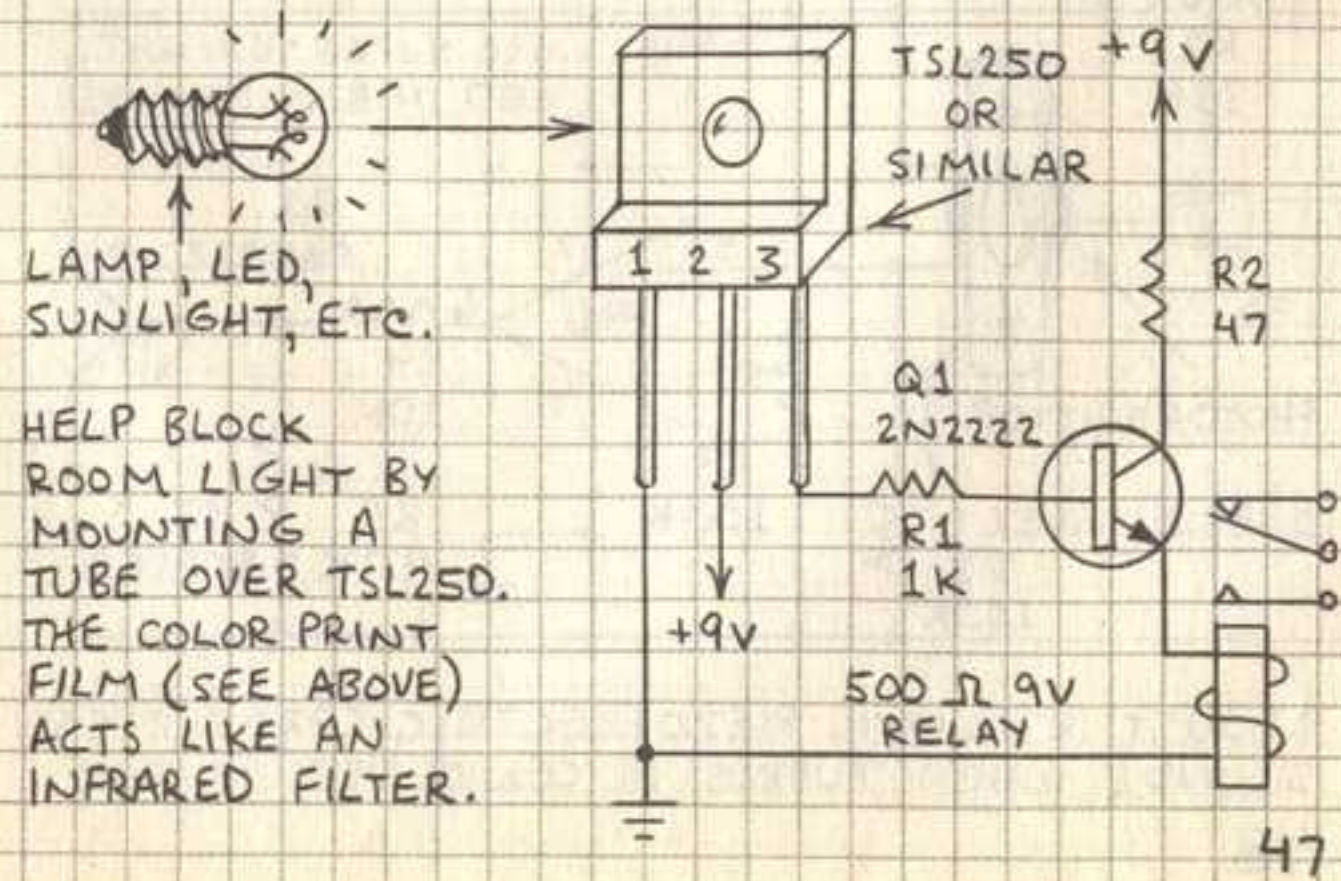

47

# OPTICAL LEVEL SENSORS

THESE OPTICAL LEVEL SENSORS HAVE AUDIBLE OUTPUTS. FOR BEST RESULTS ILLUMINATE SIDE OF LEVEL VIAL WITH LED AND PLACE LIGHT SENSOR BELOW VIAL. INSTALL IN LIGHT-TIGHT BOX.

## VARIABLE TONE LEVEL SENSOR

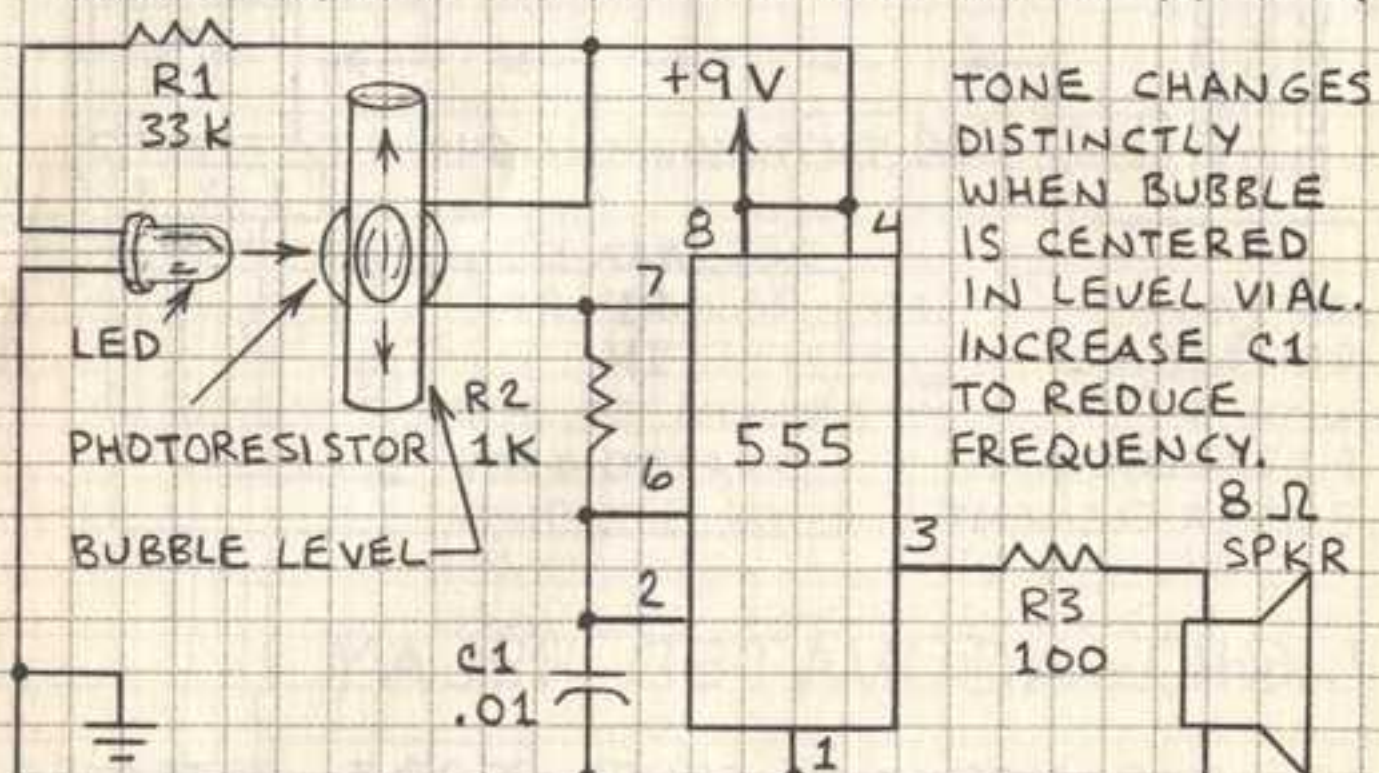

## SWITCHED TONE LEVEL SENSOR

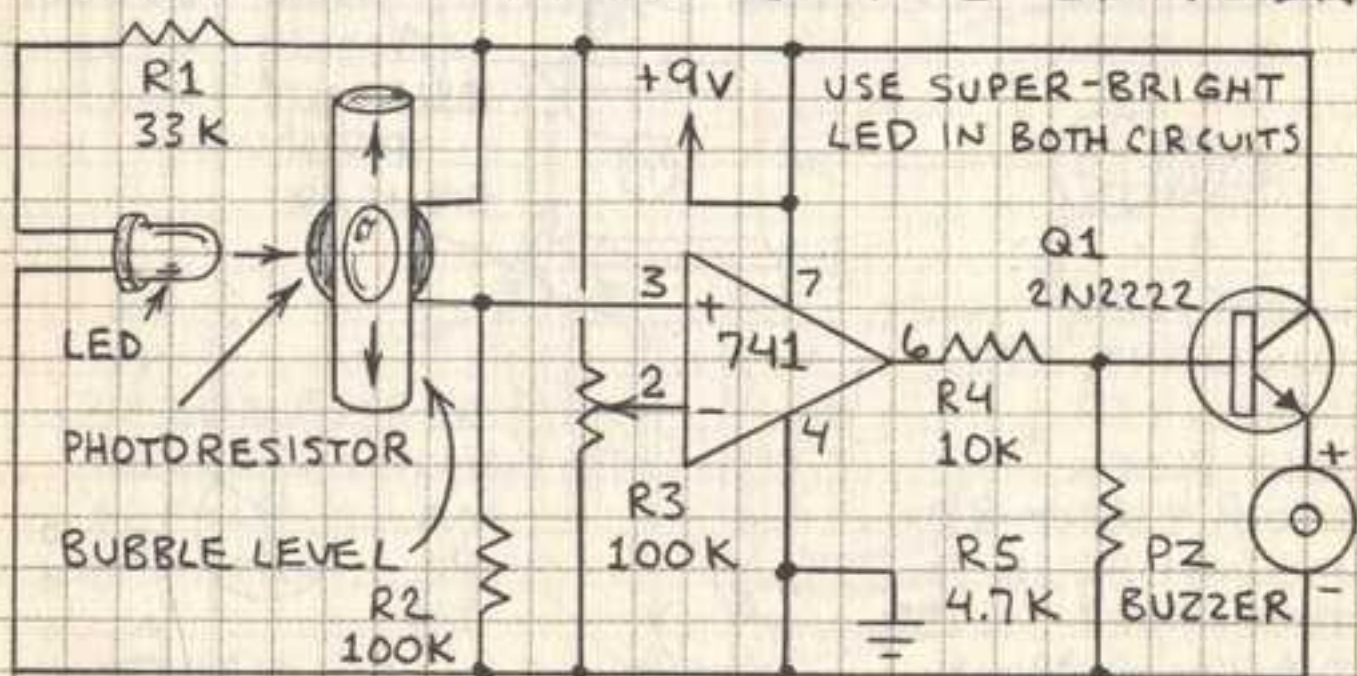

ADJUST R3 UNTIL PIEZOELECTRIC (PZ) BUZZER SOUNDS WHEN BUBBLE IS CENTERED IN VIAL.