

# Engineer's Mini-Notebook

Schematic Symbols, Device Packages,  
Design and Testing

**Radio Shack**  
A Division of Tandy Corporation  
Fort Worth, TX 76102  
PRINTED IN U.S.A.



276-5017

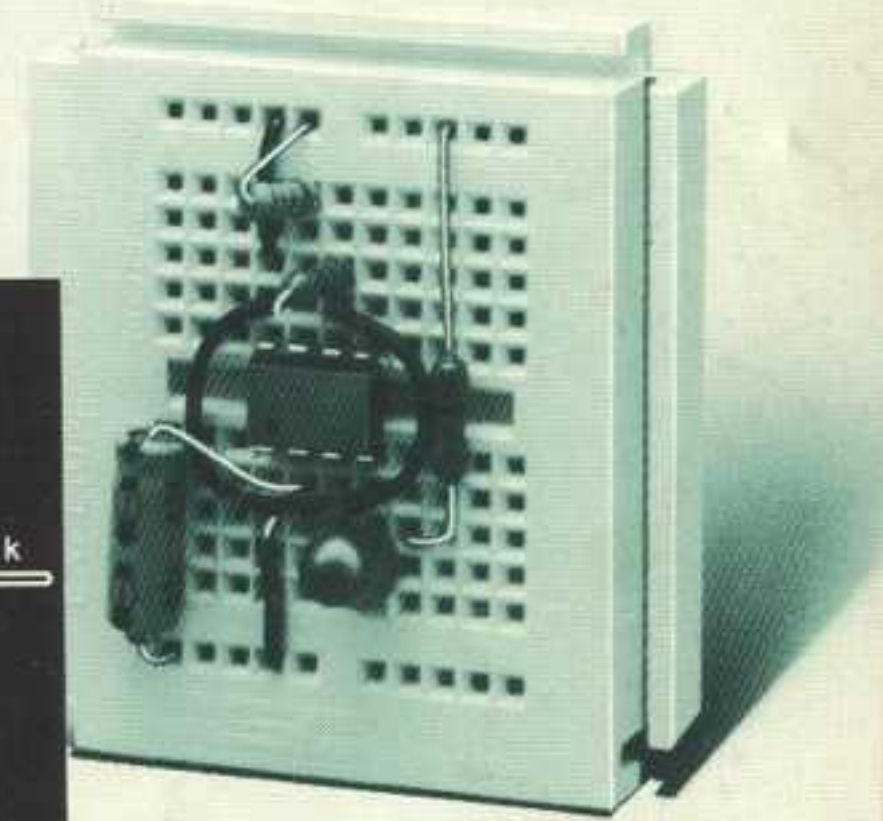
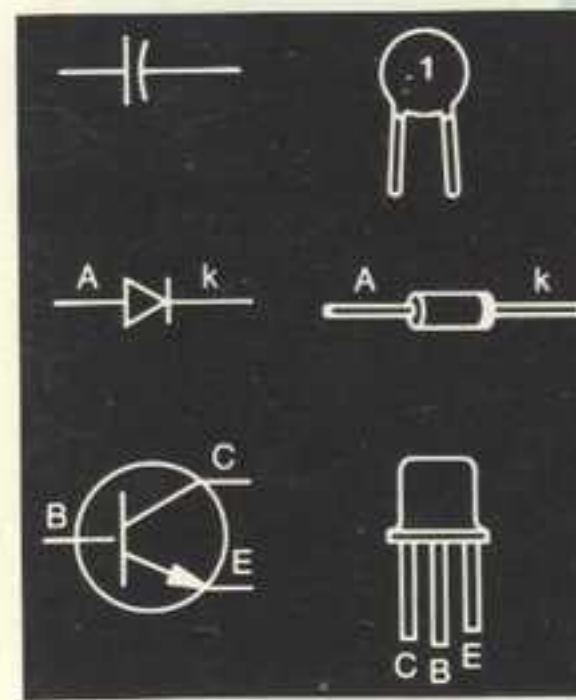

Forrest M. Mims III

**Radio Shack**



# CIRCUIT SYMBOLS

FIXED RESISTOR	VARIABLE RESISTOR	FIXED CAPACITOR	POLARIZED CAPACITOR
RECTIFIER/DIODE	ZENER DIODE	PNP TRANSISTOR	NPN TRANSISTOR
LED	SOLAR CELL	PHOTO-RESISTOR	PHOTO-TRANSISTOR
CONNECTED WIRES	UNCONNECTED WIRES	POSITIVE SUPPLY	GROUND
SPST SWITCH	SPDT SWITCH	NORMALLY OPEN PUSHBUTTON	NORMALLY CLOSED PUSHBUTTON
RELAY	TRANSFORMER	SPEAKER	PIEZO-SPEAKER
METER	LAMP	BATTERY	OP-AMP

# ENGINEER'S MINI-NOTEBOOK

## SCHEMATIC SYMBOLS, DEVICE PACKAGES, DESIGN AND TESTING

BY  
FORREST M. MIMS, III  
CONTRIBUTING EDITOR  
MODERN ELECTRONICS

FIRST EDITION  
SECOND PRINTING - 1990

A SILICONCEPTS™ BOOK

COPYRIGHT © 1988 BY FORREST M. MIMS, III  
ALL RIGHTS RESERVED

PRINTED IN THE UNITED STATES OF AMERICA



# CONTENTS

THIS BOOK INCLUDES STANDARD APPLICATION CIRCUITS AND CIRCUITS DESIGNED BY THE AUTHOR. EACH CIRCUIT WAS ASSEMBLED AND TESTED BY THE AUTHOR AS THE BOOK WAS DEVELOPED. AFTER THE BOOK WAS COMPLETED, THE AUTHOR REASSEMBLED EACH CIRCUIT TO CHECK FOR ERRORS. WHILE REASONABLE CARE WAS EXERCISED IN THE PREPARATION OF THIS BOOK, VARIATIONS IN COMPONENT TOLERANCES AND CONSTRUCTION METHODS MAY CAUSE THE RESULTS YOU OBTAIN TO DIFFER FROM THOSE GIVEN HERE. THEREFORE THE AUTHOR AND RADIO SHACK ASSUME NO RESPONSIBILITY FOR THE SUITABILITY OF THIS BOOK'S CONTENTS FOR ANY APPLICATION. SINCE WE HAVE NO CONTROL OVER THE USE TO WHICH THE INFORMATION IN THIS BOOK IS PUT, WE ASSUME NO LIABILITY FOR ANY DAMAGES RESULTING FROM ITS USE. OF COURSE IT IS YOUR RESPONSIBILITY TO DETERMINE IF COMMERCIAL USE, SALE OR MANUFACTURE OF ANY DEVICE THAT INCORPORATES INFORMATION IN THIS BOOK INFRINGES ANY PATENTS, COPYRIGHTS OR OTHER RIGHTS.

DUE TO THE MANY INQUIRIES RECEIVED BY RADIO SHACK AND THE AUTHOR, IT IS NOT POSSIBLE TO PROVIDE PERSONAL RESPONSES TO REQUESTS FOR ADDITIONAL INFORMATION (CUSTOM CIRCUIT DESIGN, TECHNICAL ADVICE, TROUBLESHOOTING ADVICE, ETC.). IF YOU WISH TO LEARN MORE ABOUT ELECTRONICS, SEE OTHER BOOKS IN THIS SERIES AND RADIO SHACK'S "GETTING STARTED IN ELECTRONICS." ALSO, READ MAGAZINES LIKE MODERN ELECTRONICS AND RADIO-ELECTRONICS. THE AUTHOR WRITES A MONTHLY COLUMN, "ELECTRONICS NOTEBOOK," FOR MODERN ELECTRONICS.

2

1. SCHEMATIC SYMBOLS	
ANTENNAS	4
WIRE, GROUND, CHASSIS	5
INDUCTORS, TRANSFORMERS	6
POWER SUPPLIES, FUSES, SHIELDING	7
ELECTRON TUBES	8
MICROPHONES, SPEAKERS, LAMPS	9
CONNECTORS	10-11
SWITCHES	12-13
RELAYS	14
MOTORS, SOLENOIDS, METERS	15
RESISTORS	16
CAPACITORS	17
SEMICONDUCTORS	18-21
2. DEVICE PACKAGES	
RESISTORS, CAPACITORS	22
DIODES	23
TRANSISTORS	24
INTEGRATED CIRCUITS	25
BATTERIES	26-27
LAMPS	28-30
3. COMPONENT HANDLING	31
ELECTROSTATIC DISCHARGE	32-34
4. COMPONENT TESTING	35
5. CIRCUIT DESIGN TIPS	36
6. CIRCUIT LAYOUT TIPS	37
7. HEATSINKING	38-39
8. SOLDERING	40-43
9. TROUBLESHOOTING	44-47
10. SAFETY PRECAUTIONS	48
	3



# 1. SCHEMATIC SYMBOLS

## ANTENNAS

EXTERNAL



DIPOLE



FOLDED DIPOLE

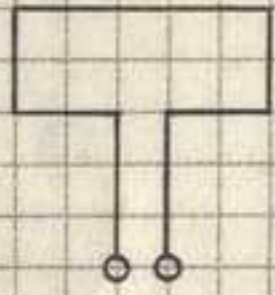

UHF LOOP



UHF BOWTIE

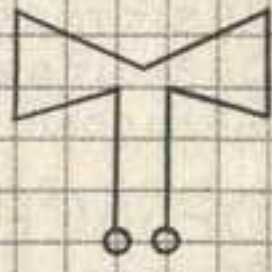

LOOP

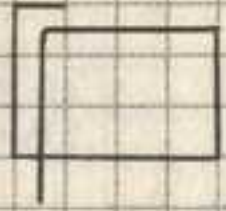

TELESCOPIC



FERRITE CORE

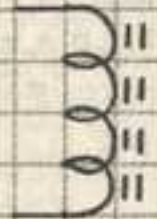

MICROWAVE HORN



ROTATABLE LOOP



EARTH STATION



## WIRE

CONNECTED



NOT CONNECTED



SHIELDED WIRE AND COAXIAL CABLE

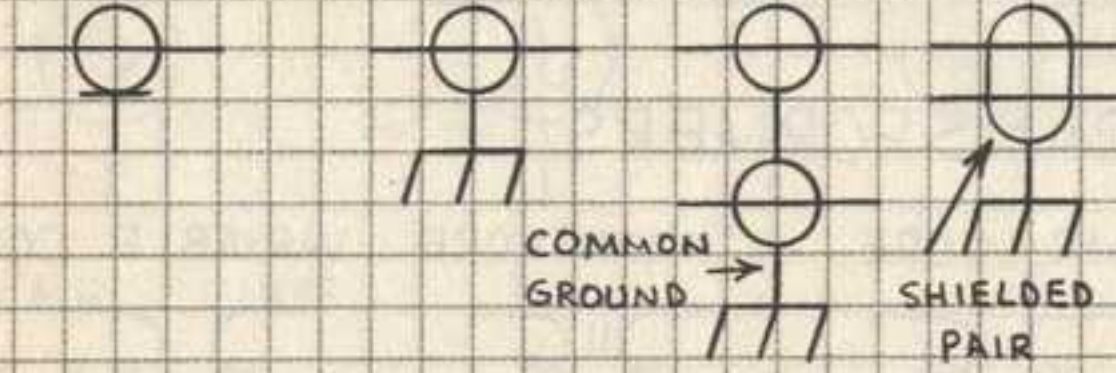

CABLE SHIELDED AT 2 POINTS

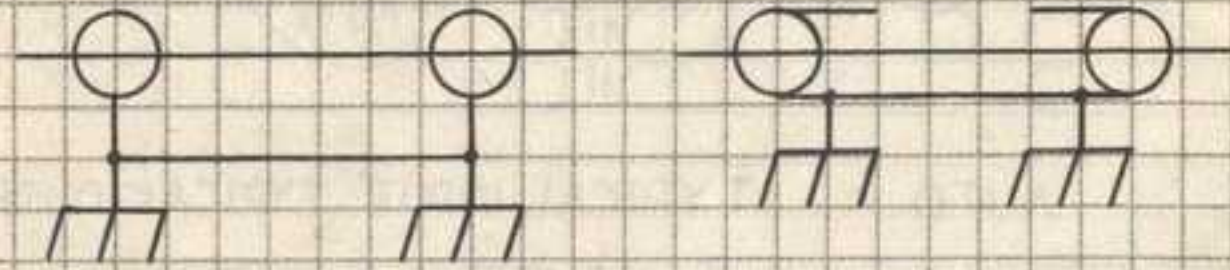

EARTH GROUND

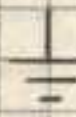

CHASSIS GROUND

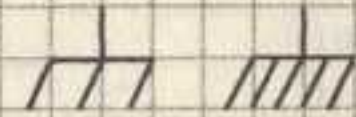

COMMON TIE POINTS

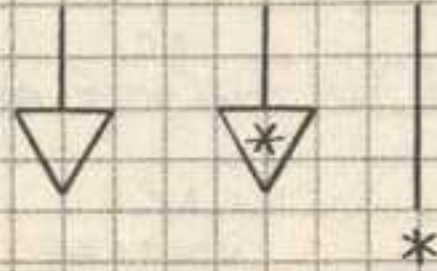

\* USE FOR TWO OR MORE COMMON TIE POINTS IN SAME CIRCUIT AND INSERT NUMBER OF RELEVANT TIE POINT.



# INDUCTORS

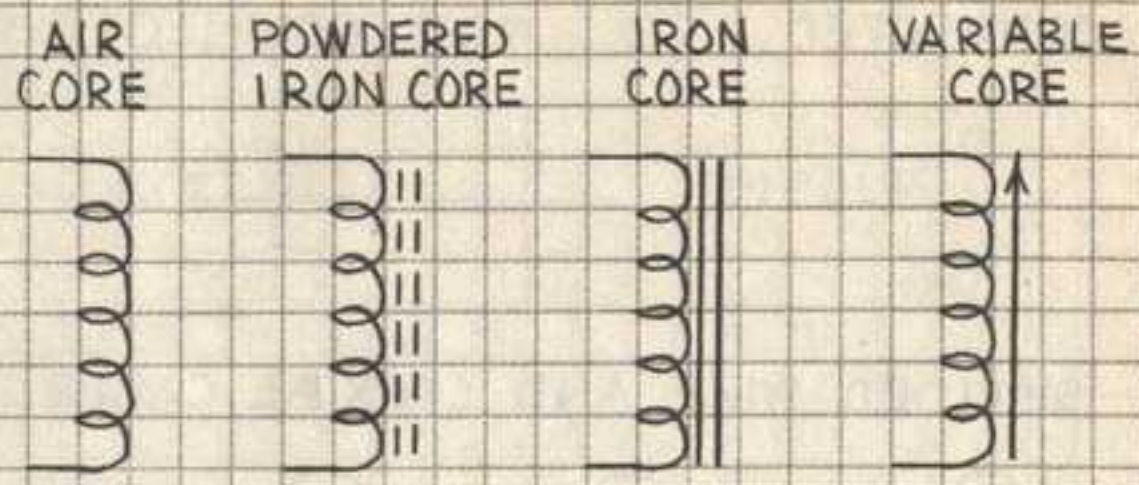

# TRANSFORMERS

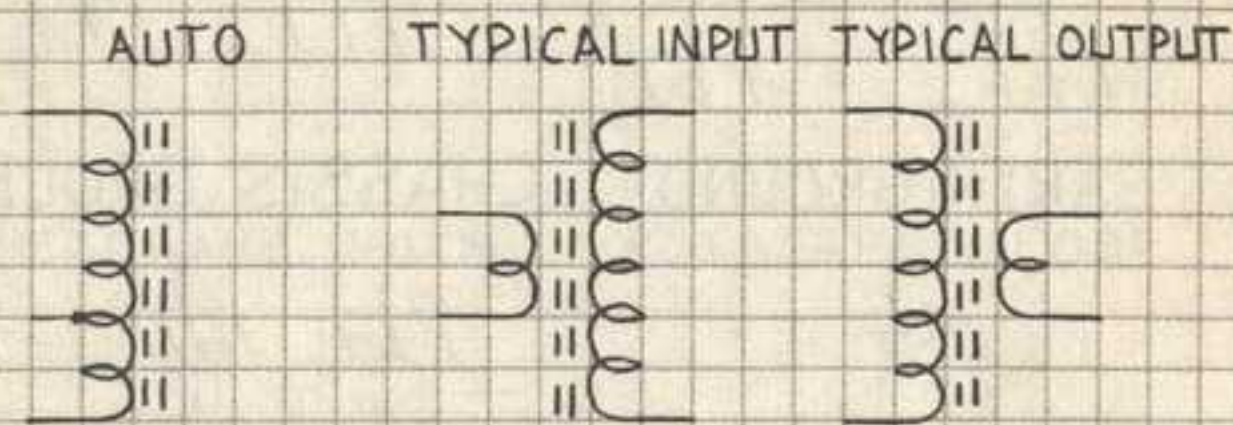
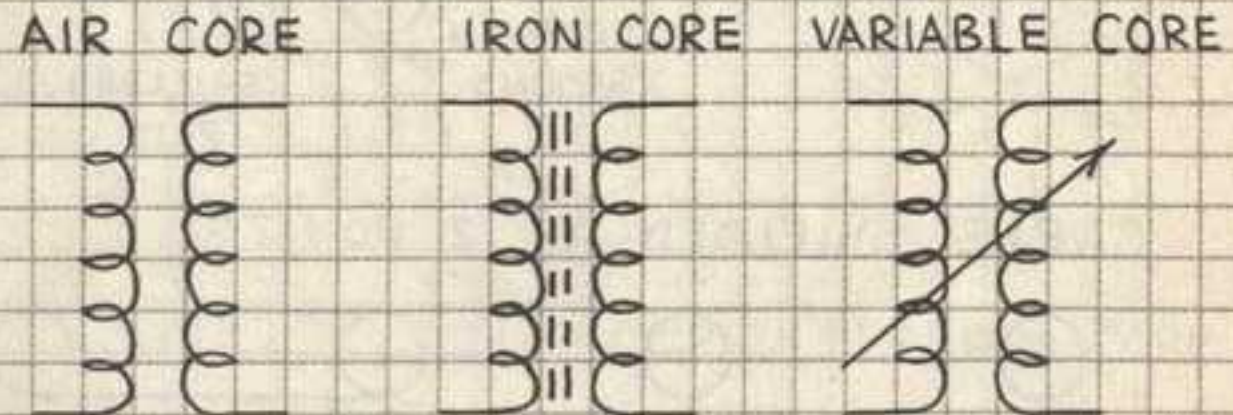

# TYPICAL POWER TRANSFORMER (TAPPED)

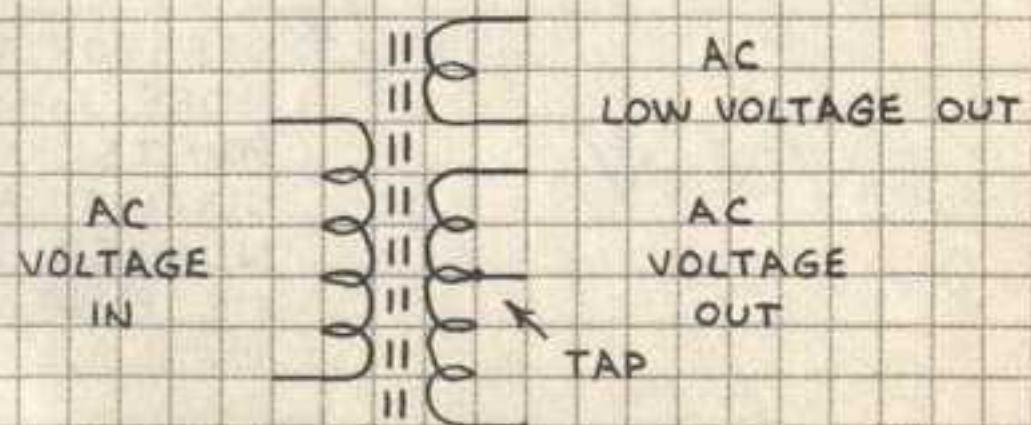

# POWER SUPPLIES



# AC CURRENT SOURCES

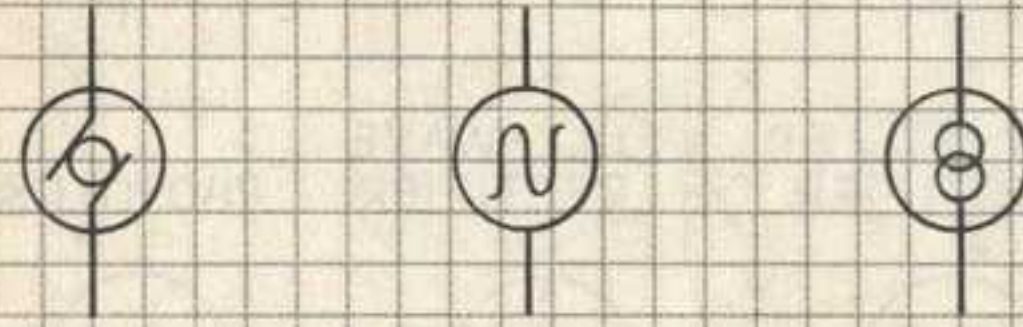

# SOLAR CELLS

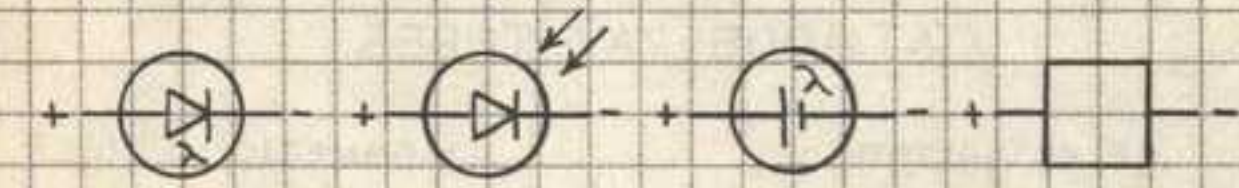

# FUSES

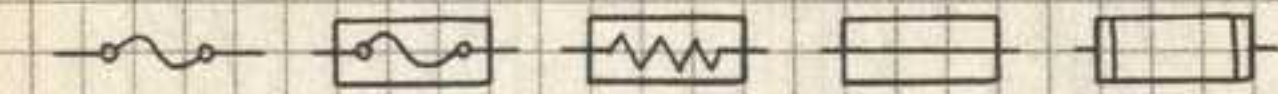

# SHIELDING

NOTE: DASHED LINE(S) ALSO USED TO INDICATE MECHANICAL CONNECTION.

# SHIELDED ENCLOSURE





## ELECTRON TUBES

DIODE

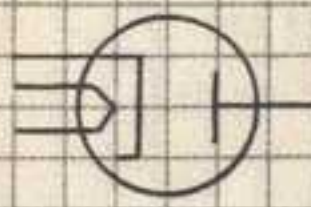

TRIODE

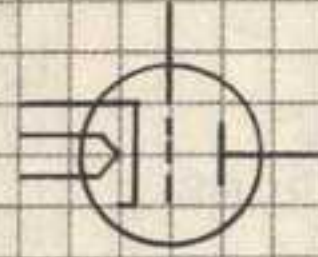

TETRODE

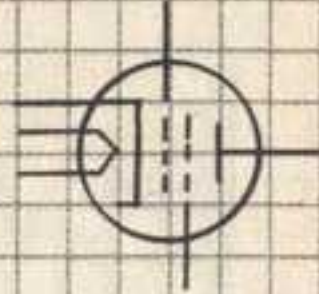

GAS-FILLED RECTIFIER

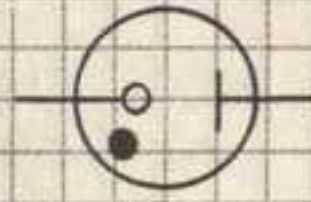

FULL-WAVE RECTIFIER

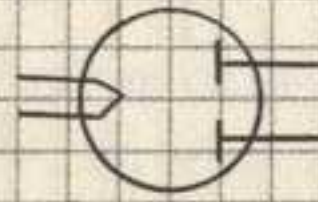

PHOTOTUBE

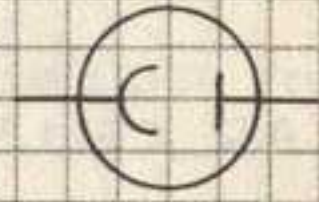

## CATHODE-RAY TUBES

ELECTROSTATIC

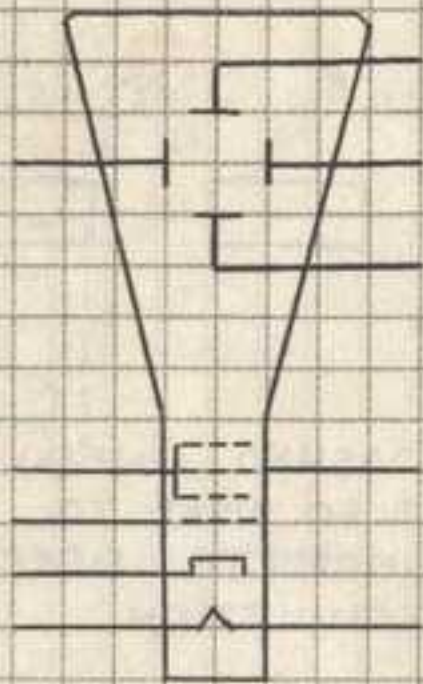

MAGNETIC

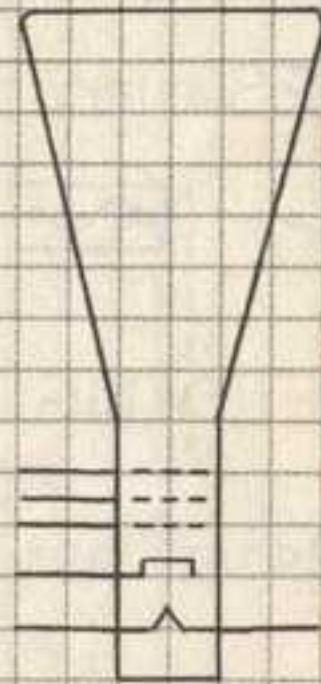

## TUBE ELEMENTS

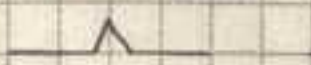

FILAMENT

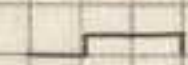

CATHODE

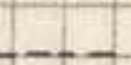

GRID



PLATE

## MICROPHONES



\*



\*

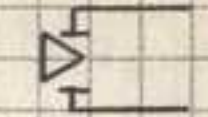

\*

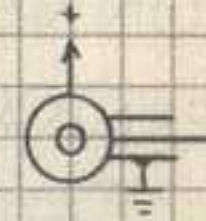

\* SPECIFY TYPE (CERAMIC, DYNAMIC, CRYSTAL, ETC.)

## SPEAKERS AND HEADSETS



SINGLE

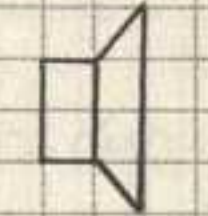

DOUBLE

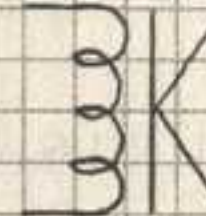

STEREO



HANDSET

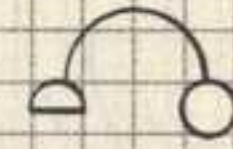
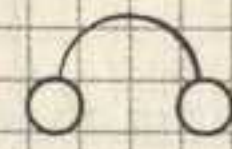
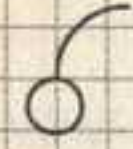

## LAMPS

### INCANDESCENT



### NEON



### XENON FLASHLAMP

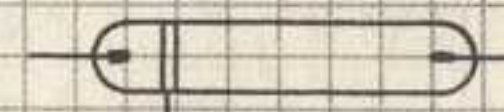

## PIEZOELECTRIC DEVICES

FREQUENCY CONTROL

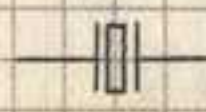

PHONO CARTRIDGES MONO



STEREO



BUZZER





# CONNECTORS

TERMINAL      TEST POINT

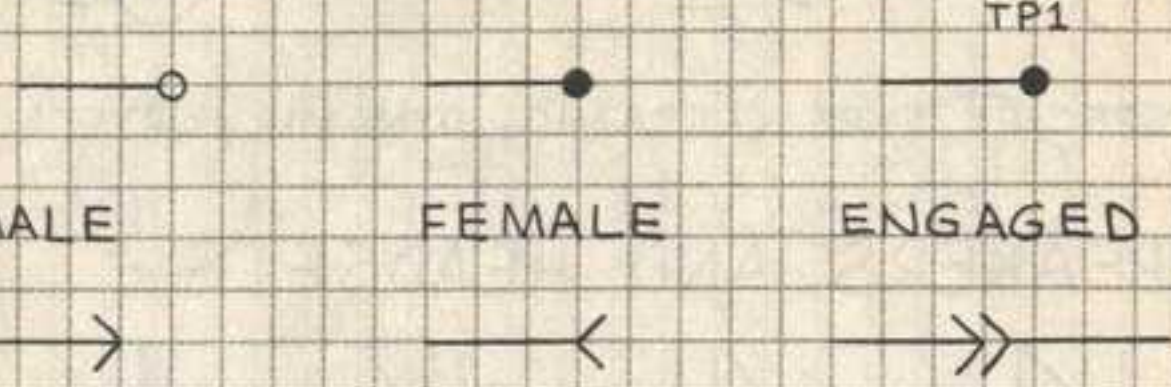

PHONO/COAXIAL PLUG      PHONO/COAXIAL JACK



2-CONDUCTOR PLUG      3-CONDUCTOR PLUG

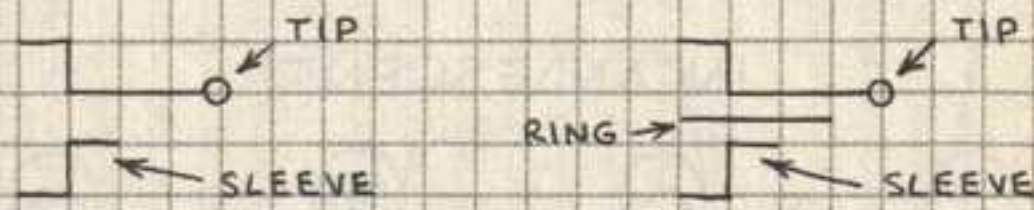

2-CONDUCTOR JACKS



3-CONDUCTOR JACKS

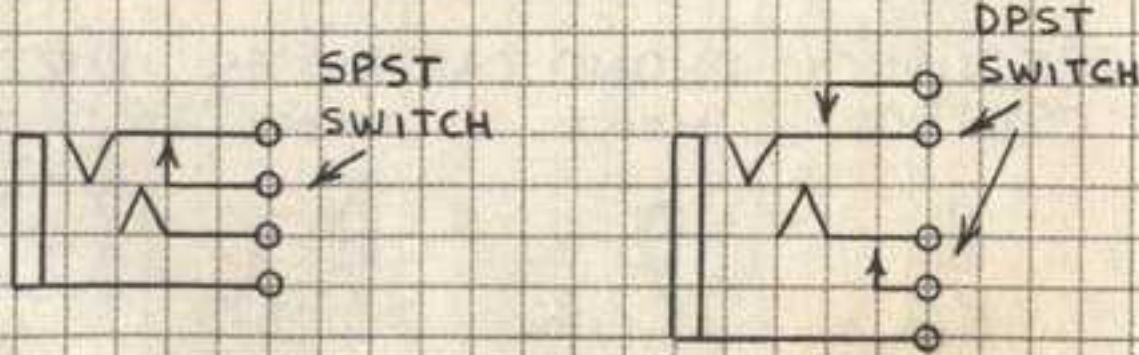

117-VOLT NON-POLARIZED PLUG

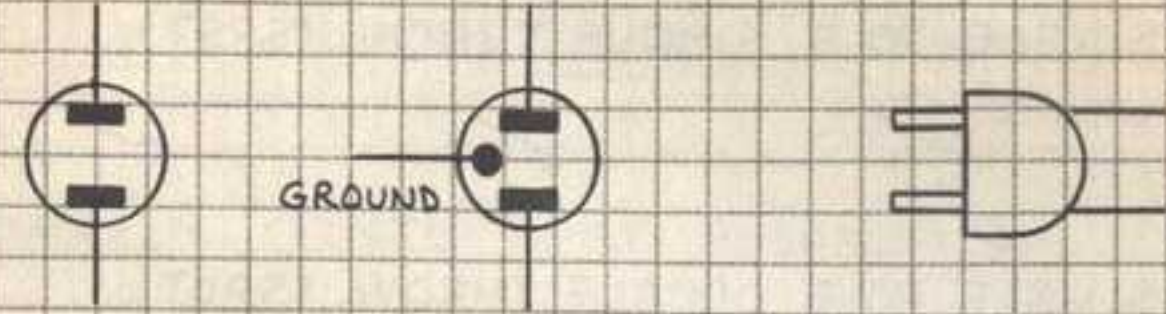

117-VOLT NON-POLARIZED SOCKET

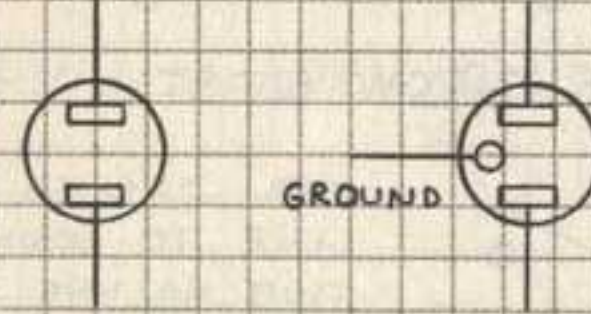

117-VOLT POLARIZED PLUG

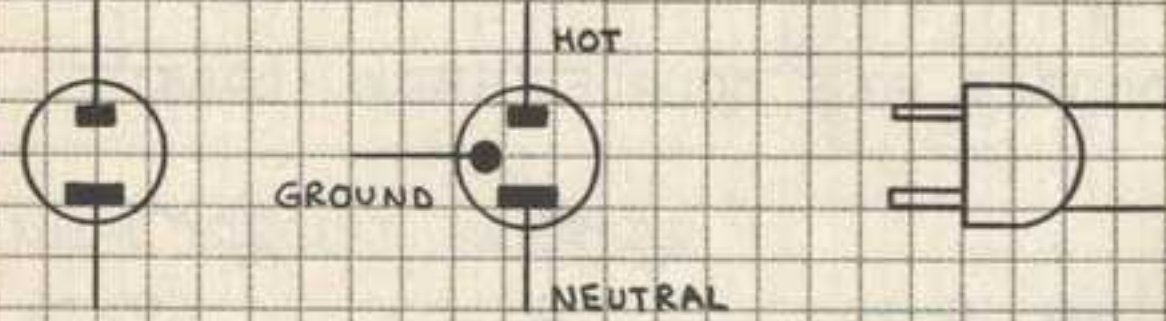

117-VOLT POLARIZED SOCKET

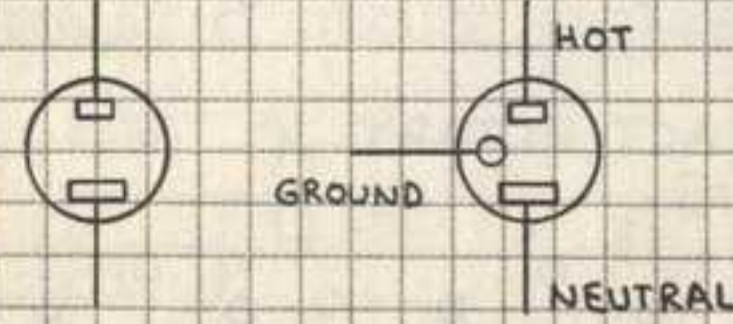

234-VOLT PLUG



234-VOLT SOCKET

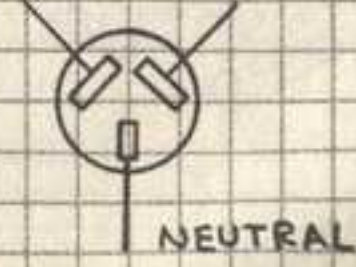



# SWITCHES

## SINGLE POLE SINGLE THROW (SPST)



## SINGLE POLE DOUBLE THROW (SPDT)

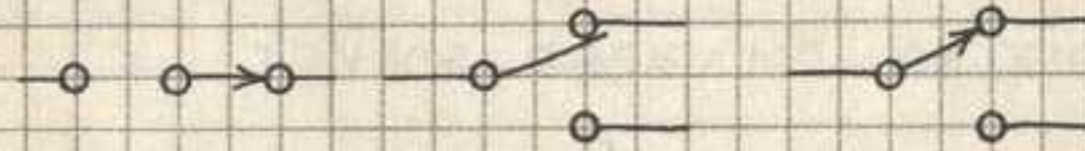

## DOUBLE POLE SINGLE THROW (DPST)

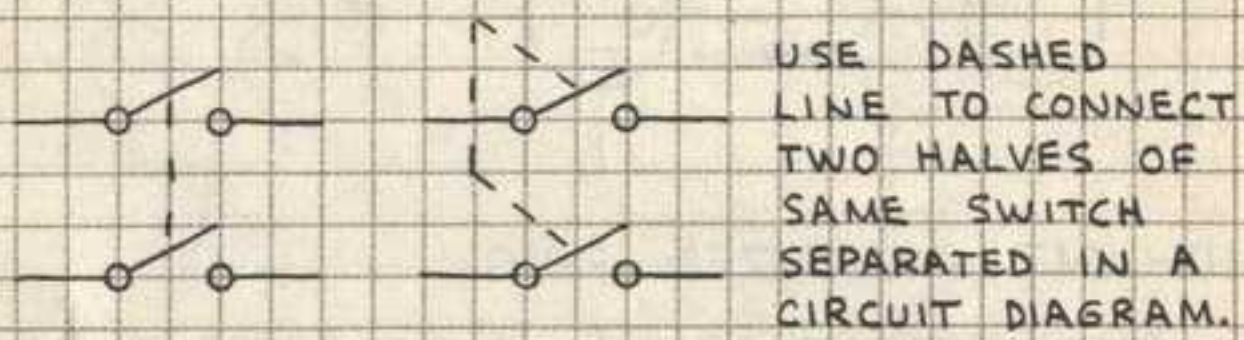

## DOUBLE POLE DOUBLE THROW (DPDT)

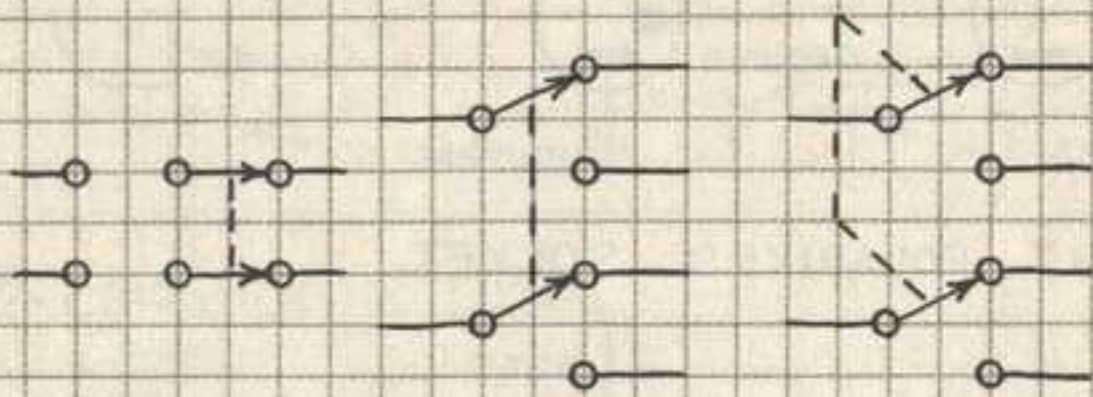

## MULTIPLE CONTACT ROTARY

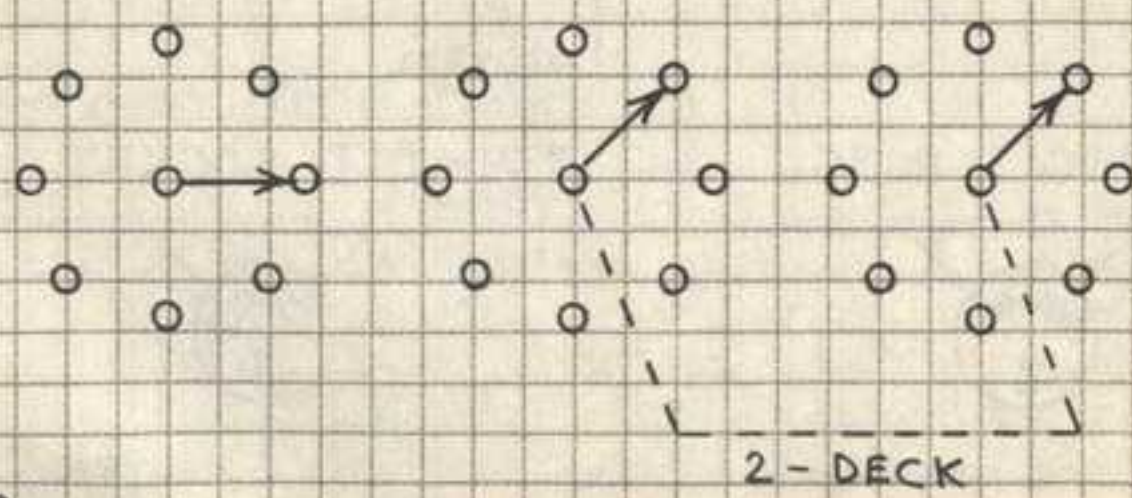

## NORMALLY OPEN SPST PUSHBUTTON

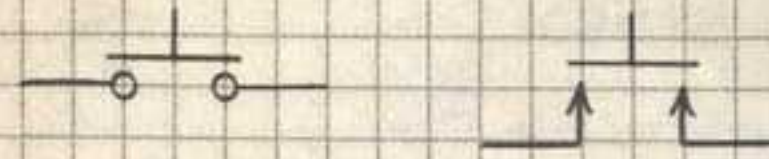

## NORMALLY CLOSED SPST PUSHBUTTON



## NORMALLY OPEN/CLOSED SPDT PUSHBUTTON



## NORMALLY OPEN DPST PUSHBUTTON

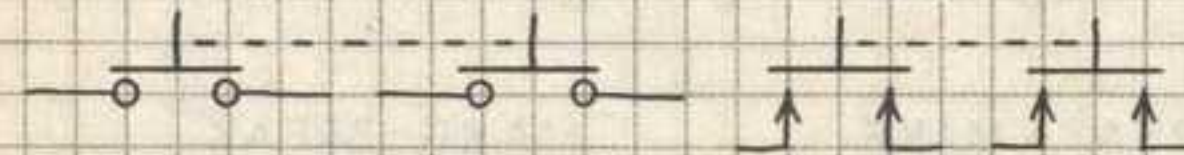

## MANUAL CIRCUIT BREAKER

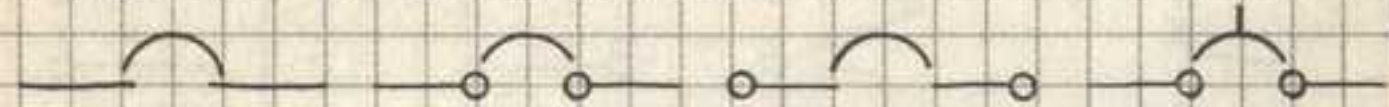

## AUTOMATIC CIRCUIT BREAKER



## TELEGRAPH KEY



## REED SWITCH

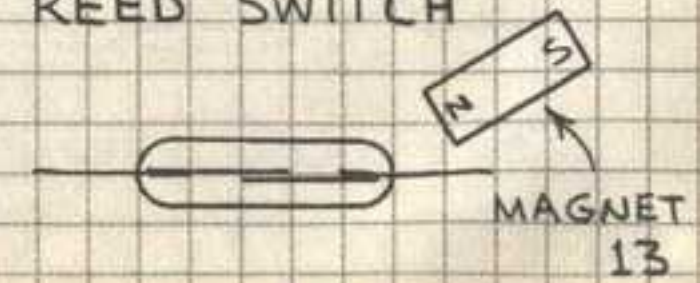



# RELAYS

## COMPLETE RELAY SYMBOLS

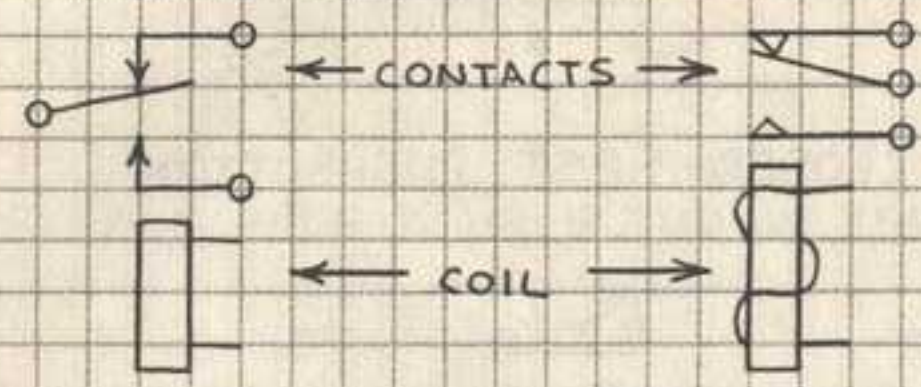

## MOST COMMON RELAY CONTACTS:

MAKE (SPST, NORMALLY OPEN)

BREAK (SPST, NORMALLY CLOSED)

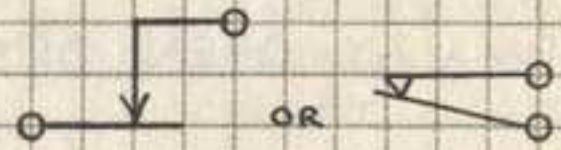
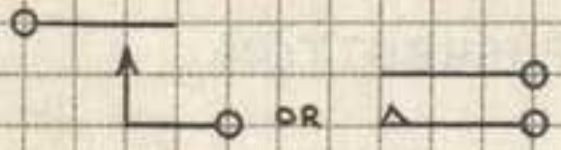

BREAK-MAKE (SPDT)

MAKE-BREAK (SPDT)

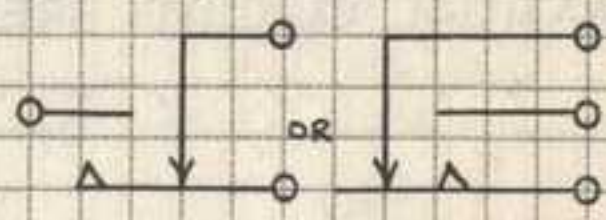
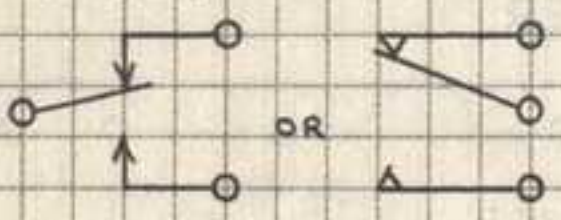

DPST

DPDT

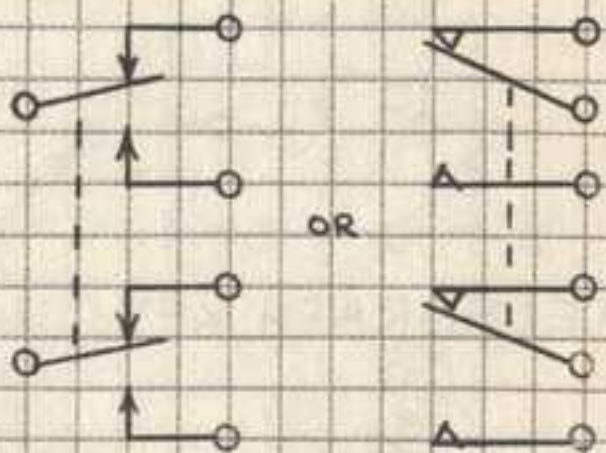
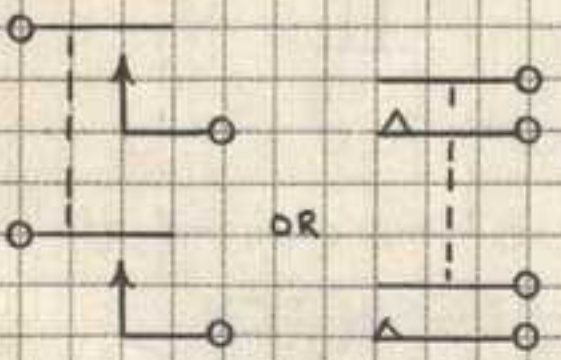

# MOTORS



PHONO MOTOR

3-PHASE

4-PHASE

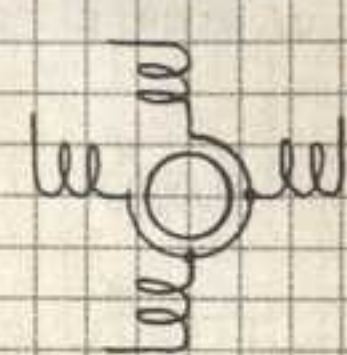
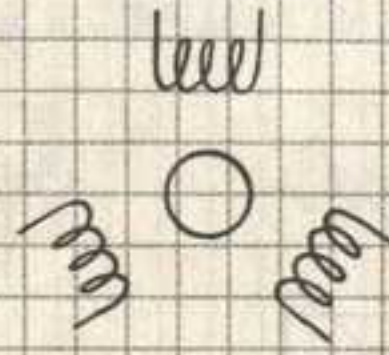
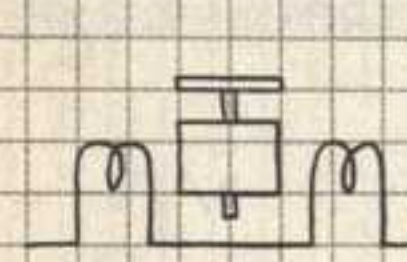

## SOLENOIDS

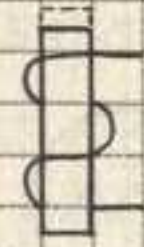

## METERS

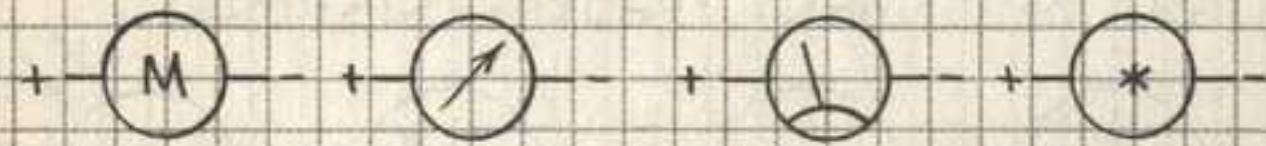

\* INSERT APPROPRIATE DESIGNATION (V=VOLTMETER; A= AMMETER; mA=MILLIAMMETER; ETC.)

## DELAY LINE

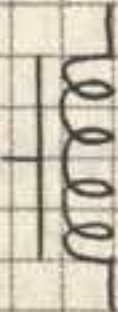

\* INSERT DELAY TIME.



# RESISTORS

FIXED



TAPPED

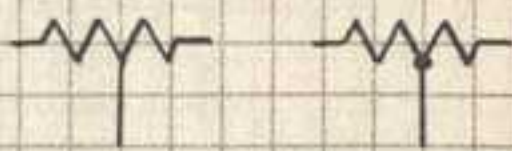

VARIABLE (POTENTIOMETERS, TRIMMERS, ETC.)

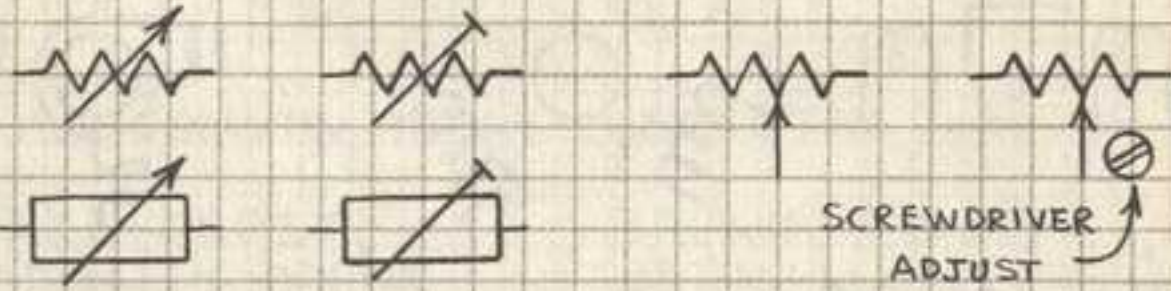

VOLTAGE DEPENDENT      CURRENT DEPENDENT



LIGHT DEPENDENT (PHOTORESISTORS)

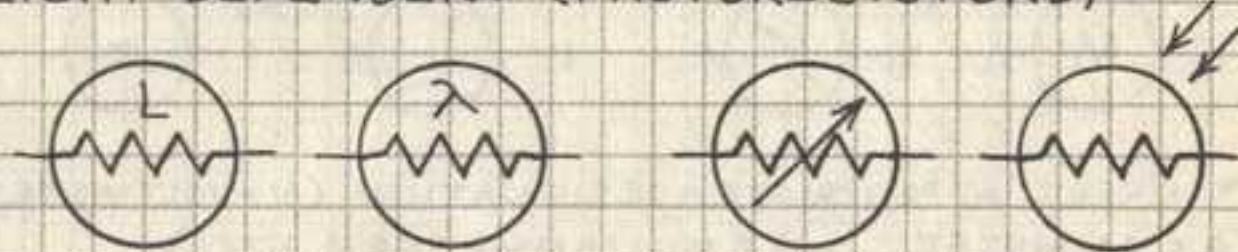

TEMPERATURE DEPENDENT (THERMISTORS)

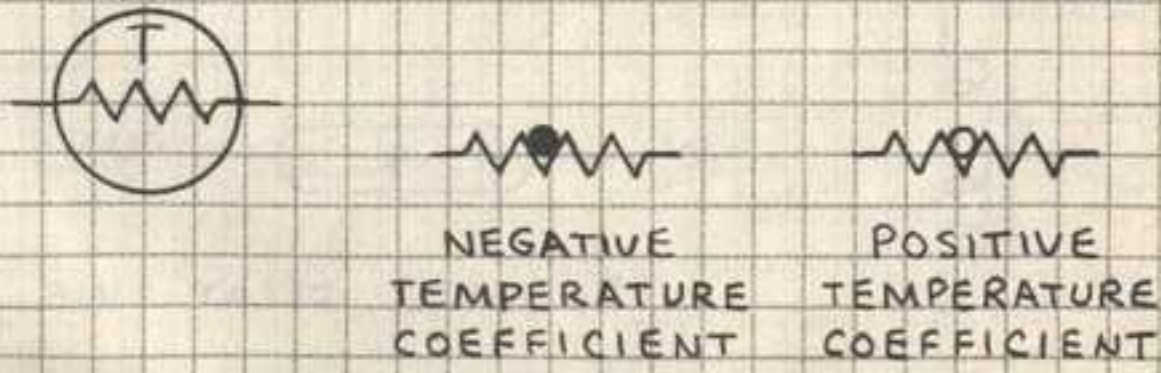

# CAPACITORS

FIXED (NON-POLARIZED)



FIXED (POLARIZED)

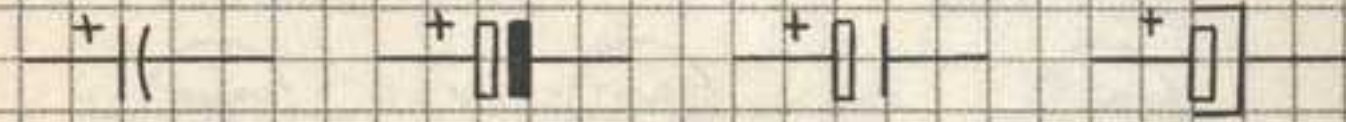

VARIABLE

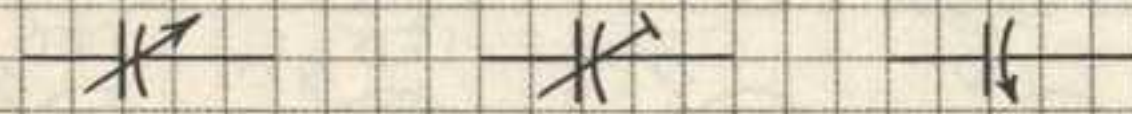

GANGED VARIABLE



SPLIT STATOR



FEED THROUGH

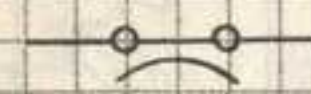

VOLTAGE VARIABLE (VARACTOR)

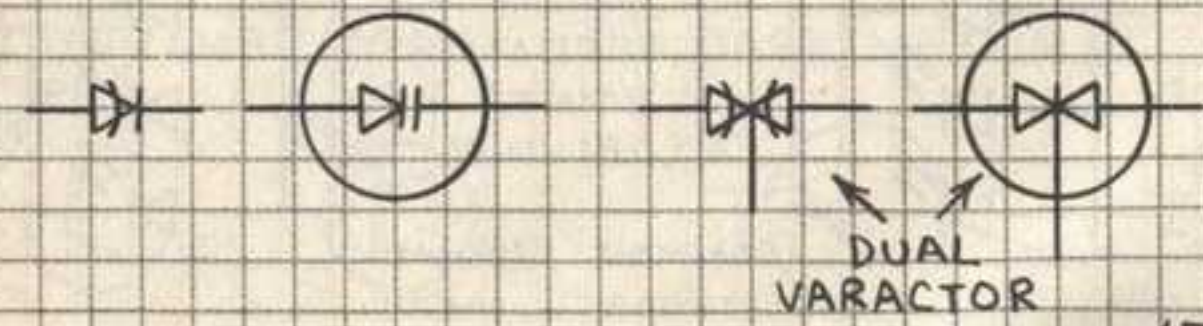



# DIODES

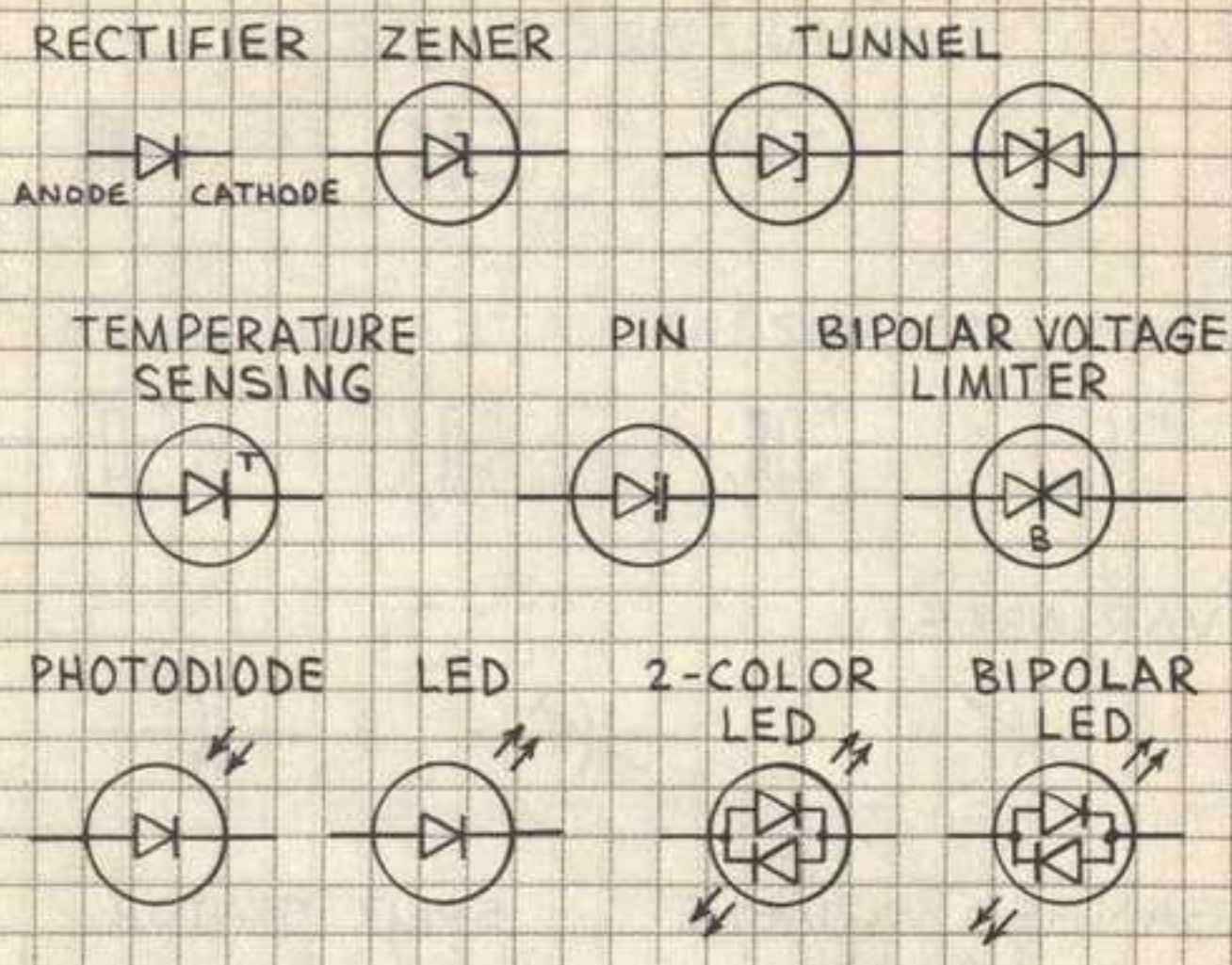

# 7-SEGMENT LED NUMERIC READOUTS

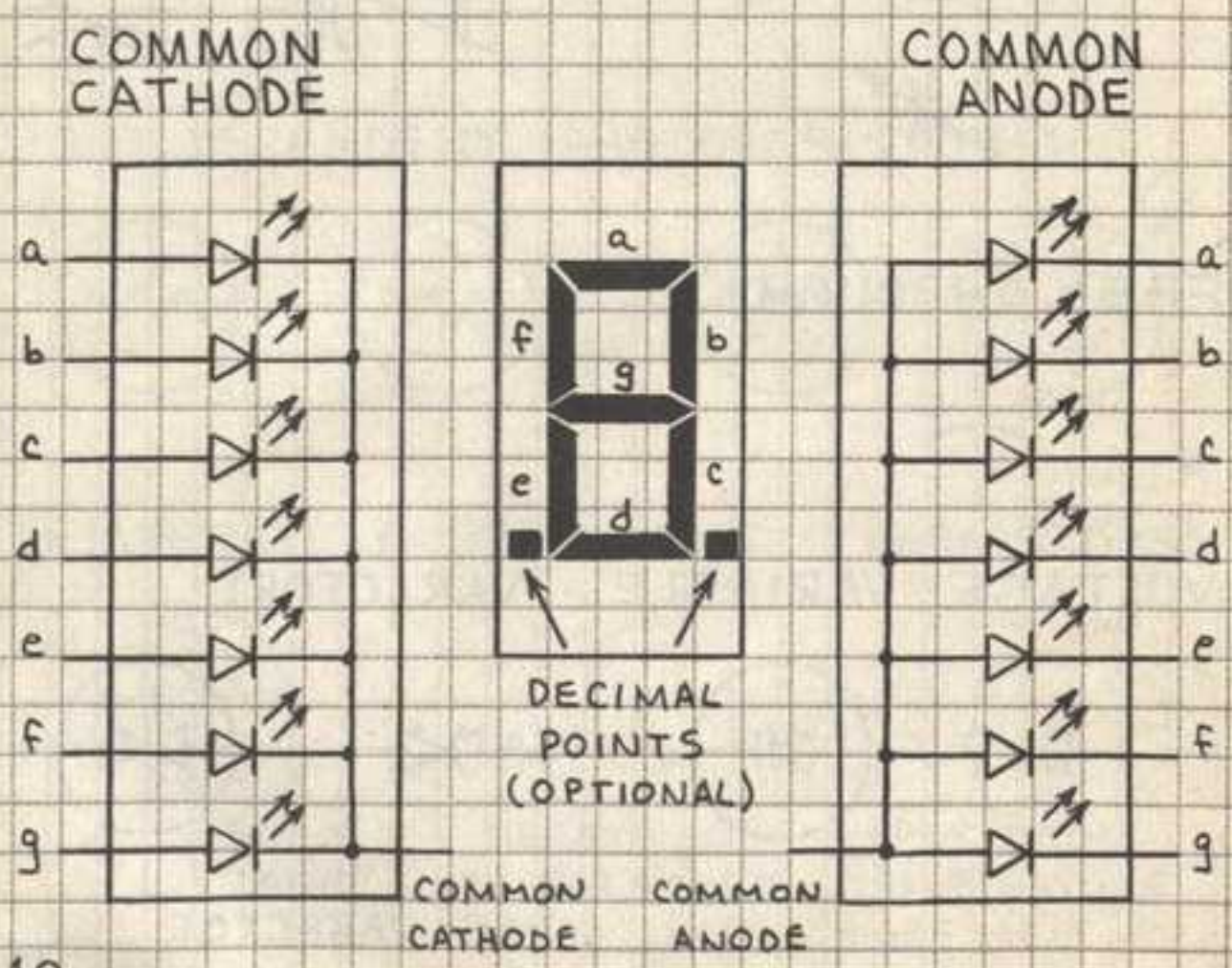

# 3-LAYER SWITCHES (DIACS)

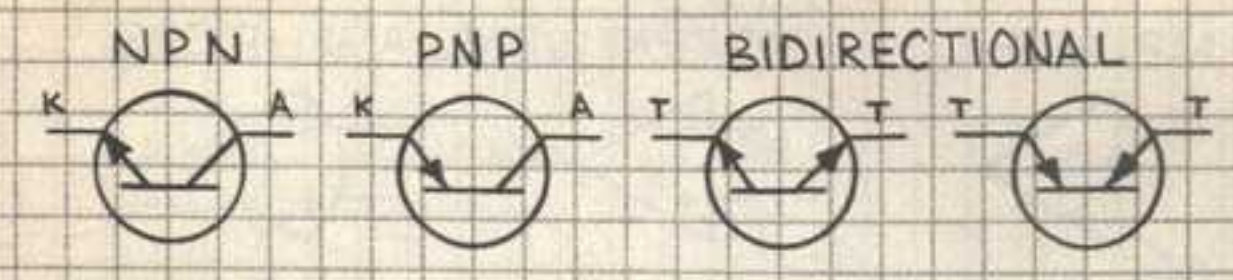

# 4-LAYER SWITCHES

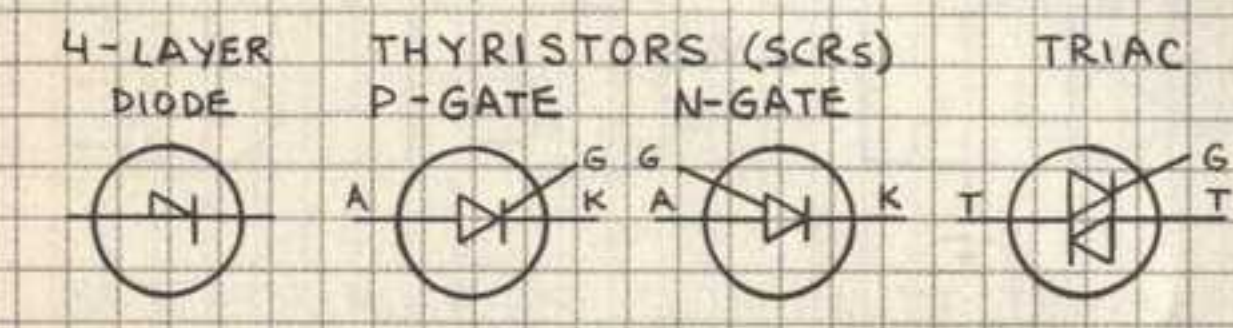

# TRANSISTORS

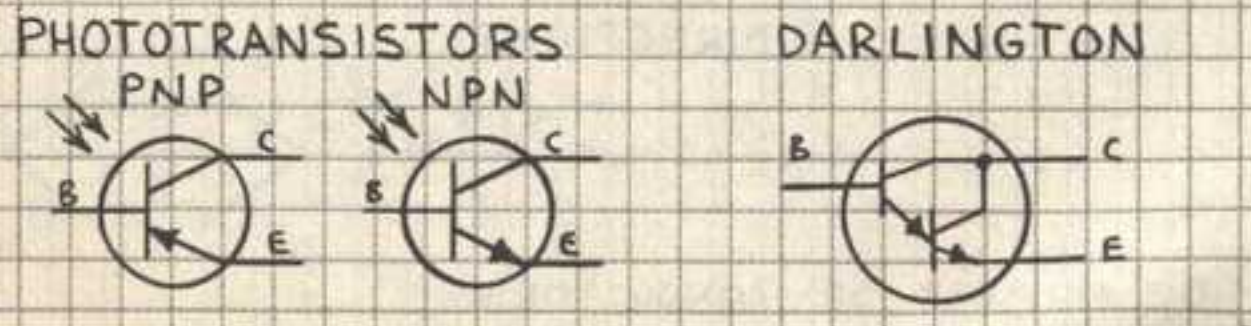
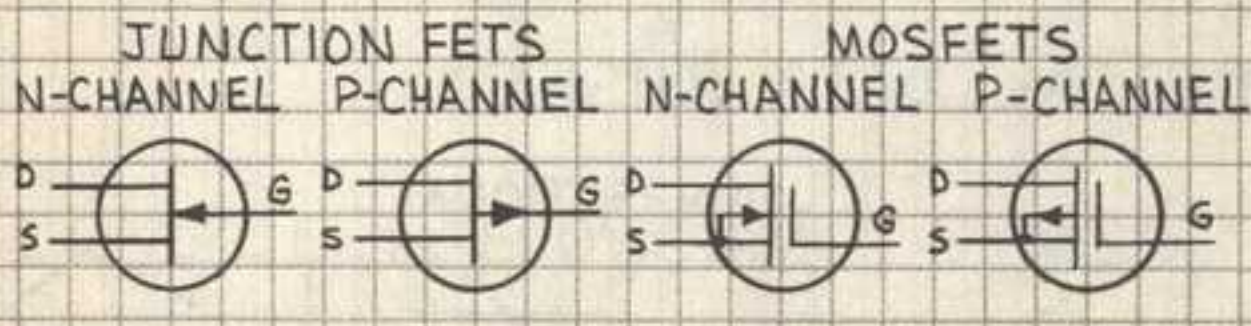
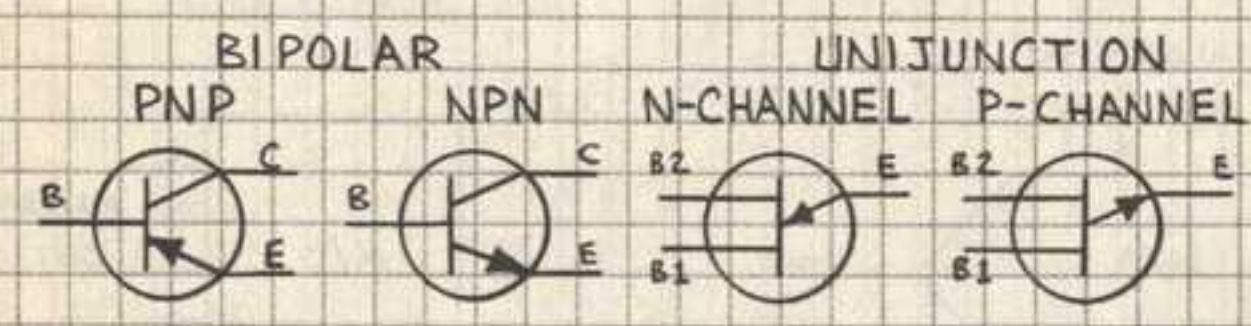



# ANALOG CIRCUITS

AMPLIFIER

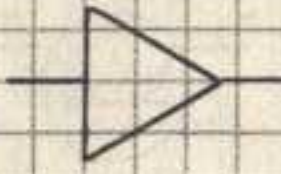

OPERATIONAL AMPLIFIERS

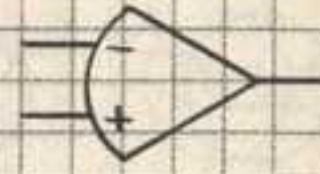

VOLTAGE REGULATOR

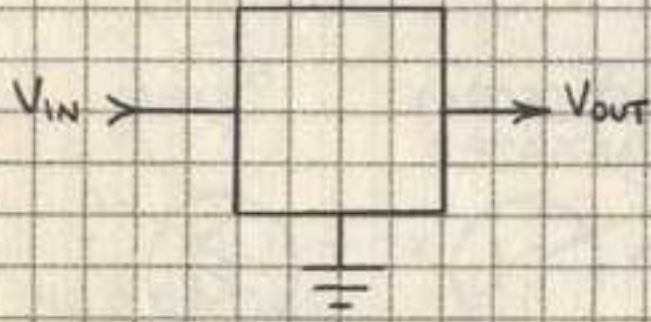

TIMERS, ETC.



# CONVERTER CIRCUITS

DIGITAL-TO-ANALOG

ANALOG-TO-DIGITAL

BINARY IN

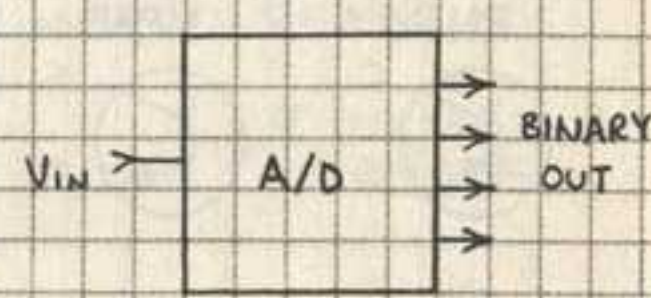
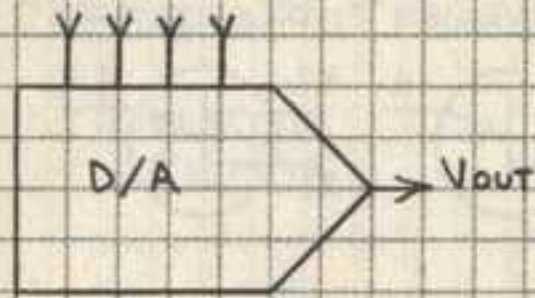

# DIGITAL DATA BUSES

UNIDIRECTIONAL



BIDIRECTIONAL

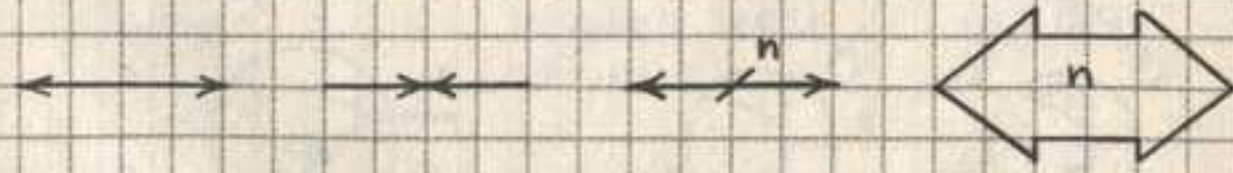

n = NUMBER OF CONDUCTORS  
20

# DIGITAL CIRCUITS

LOGIC GATES

AND

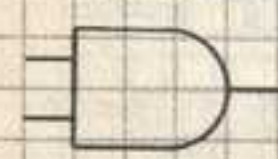

NAND

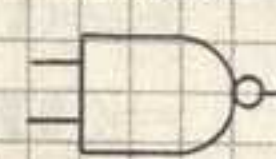

OR



NOR

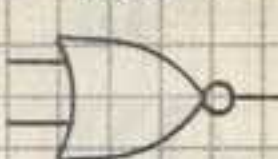

EXCLUSIVE OR



EXCLUSIVE NOR



INVERTERS

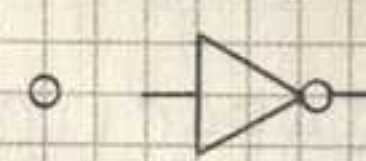

3-STATE BUFFERS

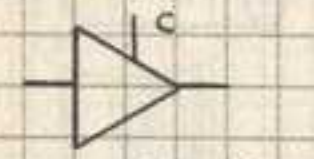

SCHMITT TRIGGERS



C = CONTROL

FLIP-FLOPS

SR

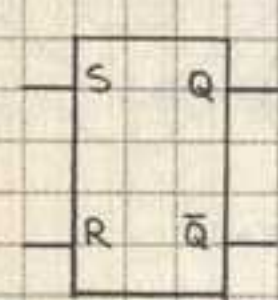

JK

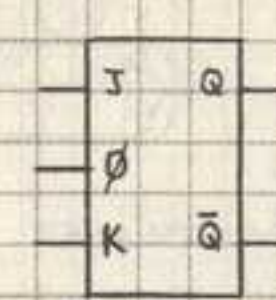

T



# COMPUTER FLOWCHART SYMBOLS

BEGIN/IN DECISION OPERATION FLOW

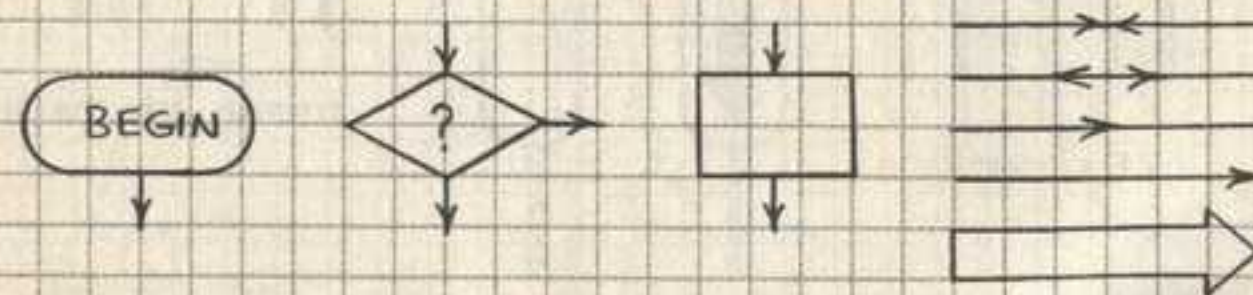



## 2. DEVICE PACKAGES

### RESISTORS

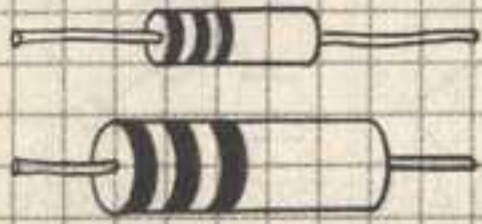

CARBON COMPOSITION



CARBON FILM

### CAPACITORS

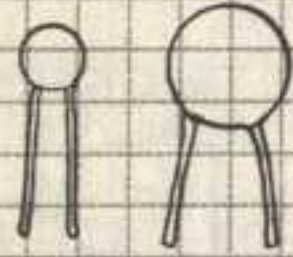

CERAMIC DISK

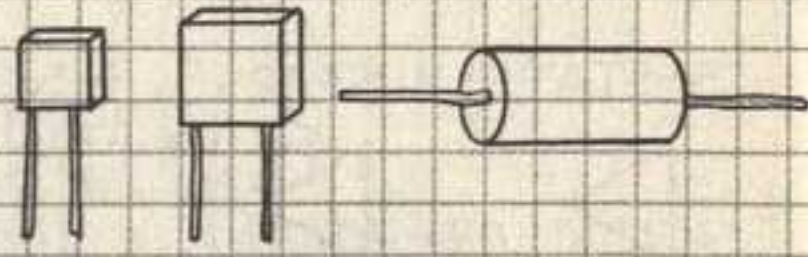

MOLDED MULTILAYER CERAMIC

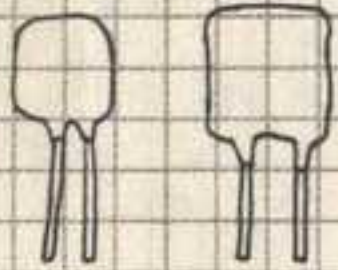

CONFORMALLY COATED MULTILAYER CERAMIC

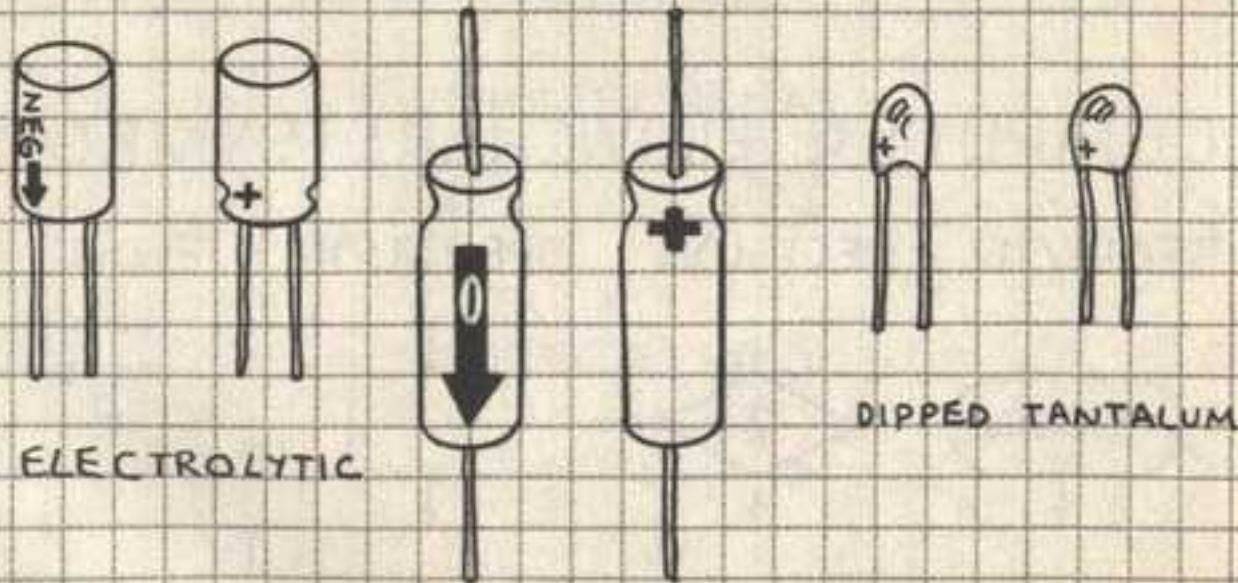

ELECTROLYTIC

DIPPED TANTALUM

### DIODES

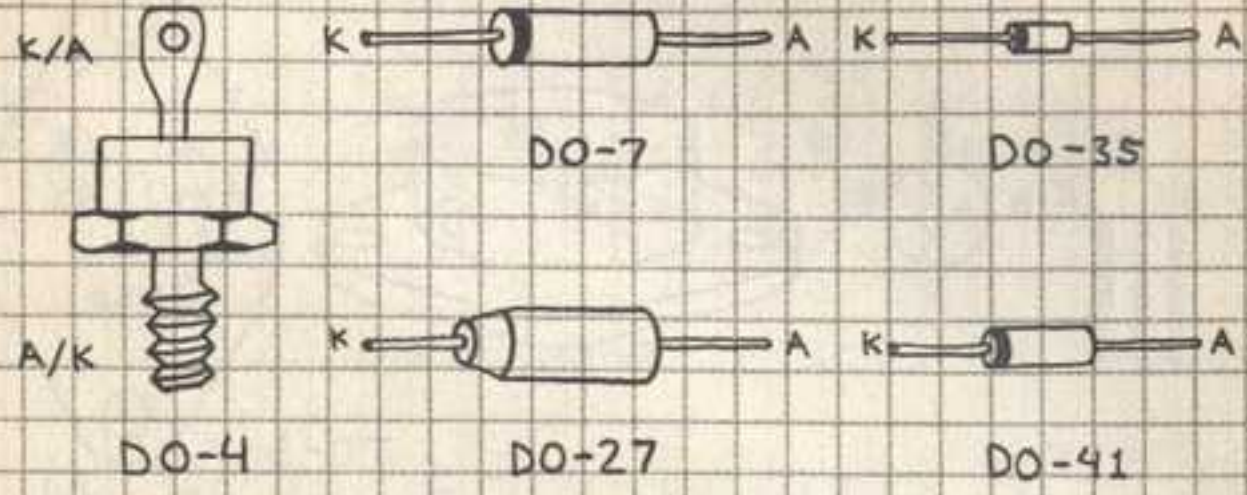

### BRIDGE RECTIFIERS

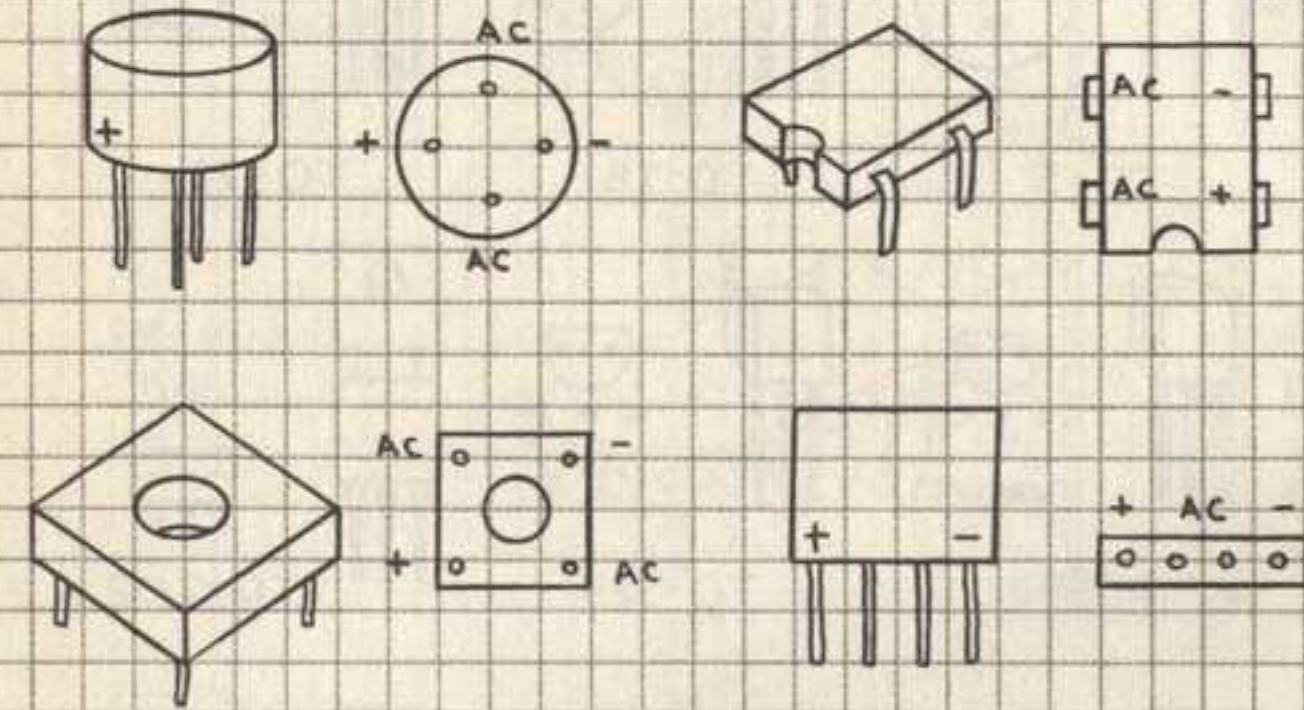

NOTE: ALWAYS CONSULT DEVICE SPECIFICATIONS TO VERIFY PIN IDENTIFICATION.

### LIGHT EMITTING DIODES

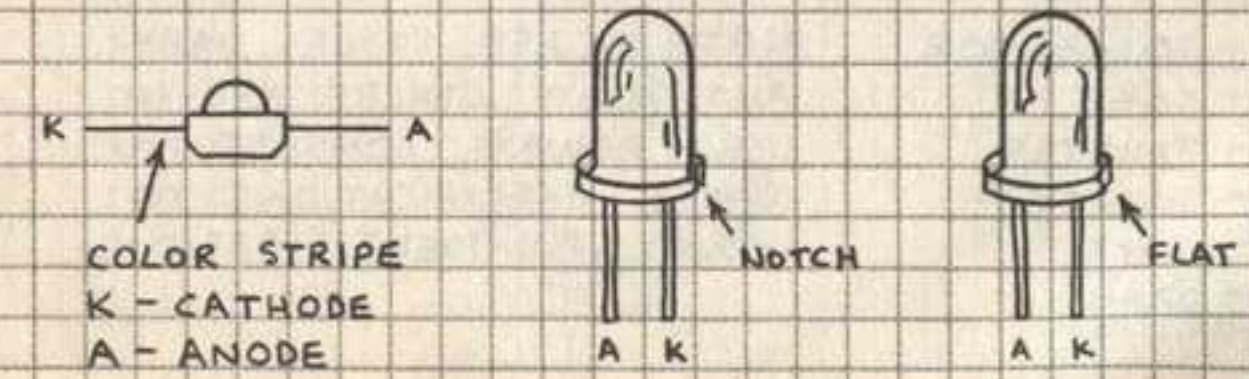



# TRANSISTORS (BOTTOM VIEW)

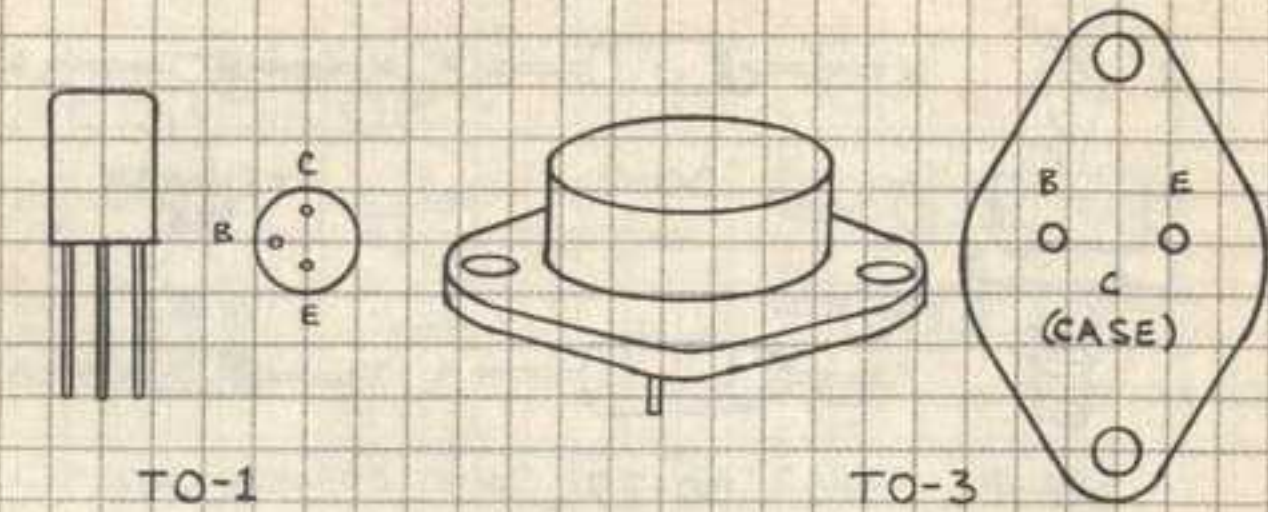

TO-1

TO-3

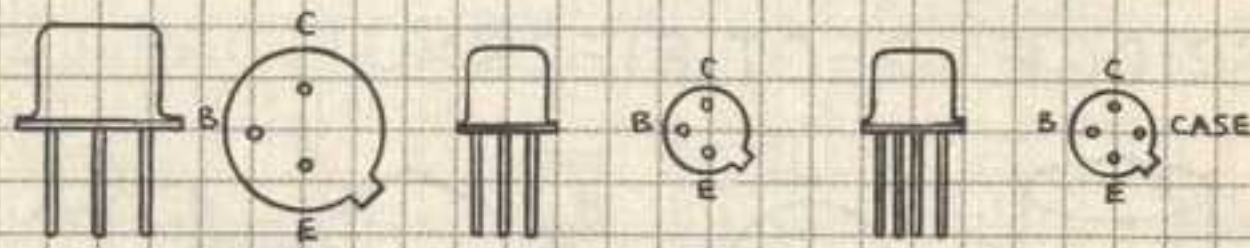

TO-5

TO-18

TO-72

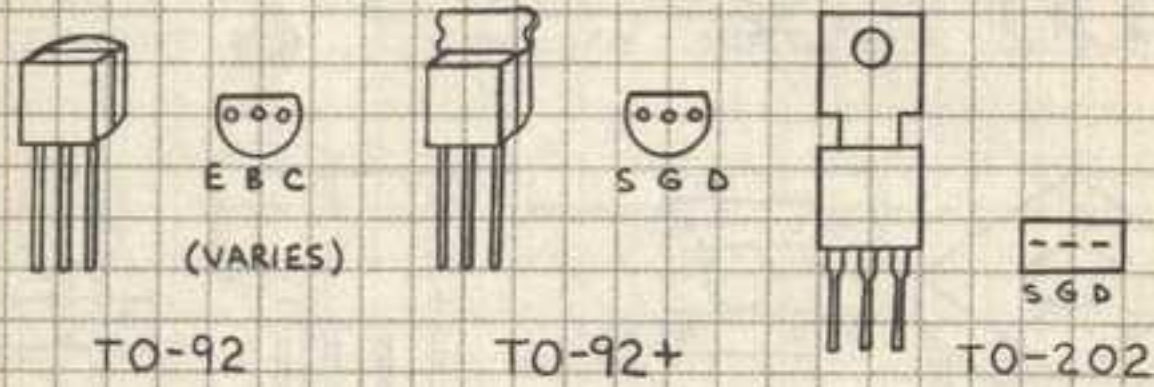

TO-92

TO-92+

TO-202

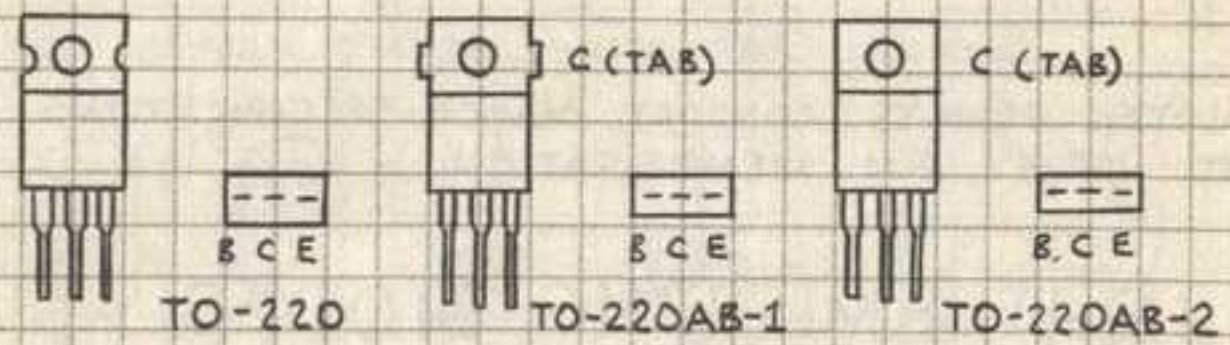

TO-220

TO-220AB-1

TO-220AB-2

C - COLLECTOR  
 B - BASE  
 E - EMITTER  
 S - SOURCE  
 G - GATE  
 D - DRAIN

NOTE: CASE STYLES VARY AND MANY OTHERS ARE IN USE. ALWAYS CONSULT DEVICE SPECIFICATIONS TO VERIFY PIN IDENTIFICATION.

# OPTOCOUPLEDERS (TOP VIEW)

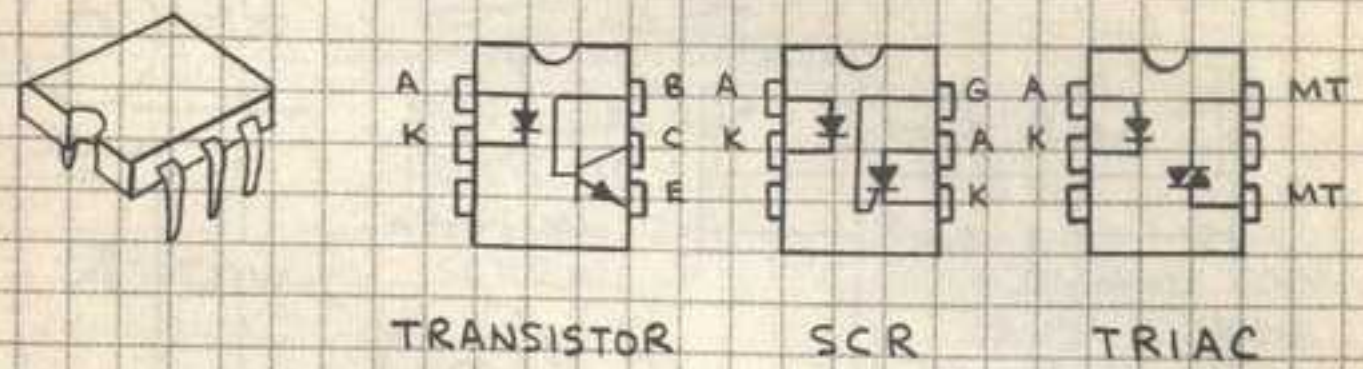

TRANSISTOR

SCR

TRIAC

# INTEGRATED CIRCUITS (TOP VIEW)

8-PIN MINI-DIP

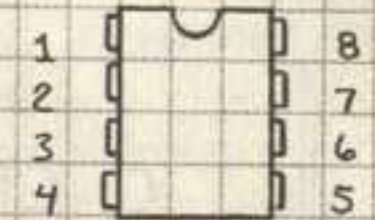
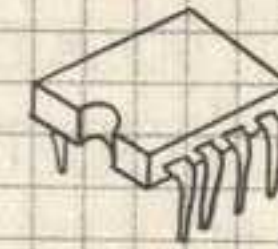

14-PIN DIP

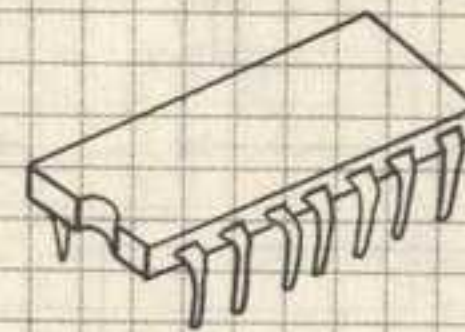

14-PIN SMALL OUTLINE (SO-14)

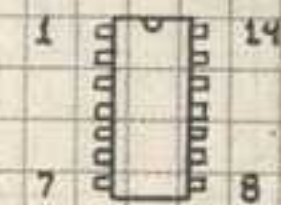
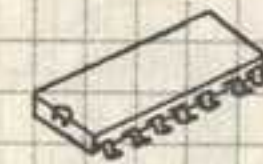

PLASTIC LEADED CHIP CARRIER (PLCC)

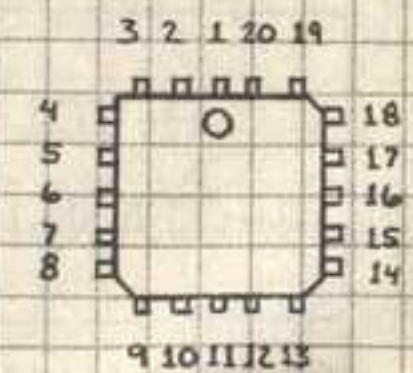
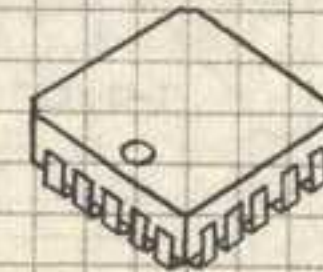



# BATTERIES

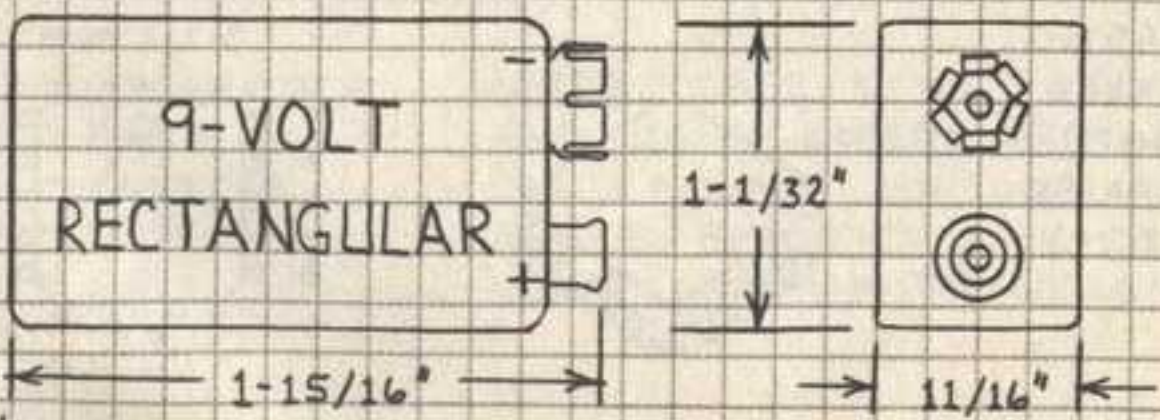
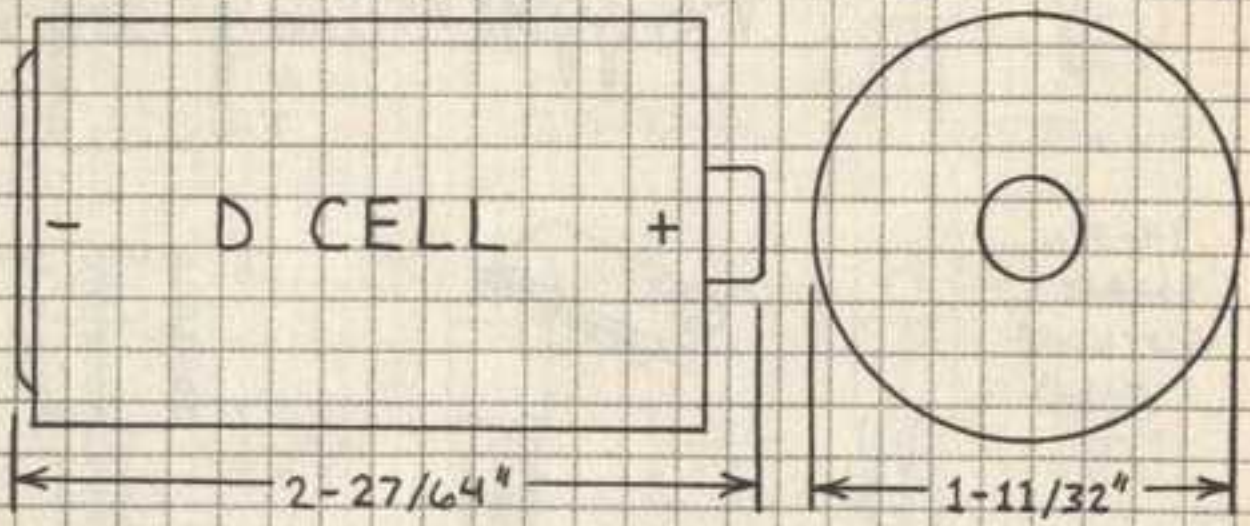
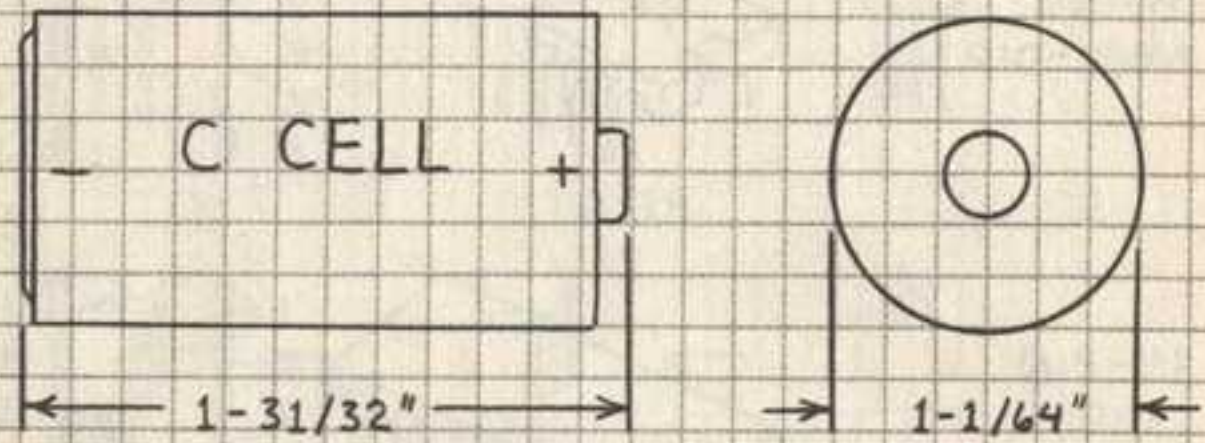
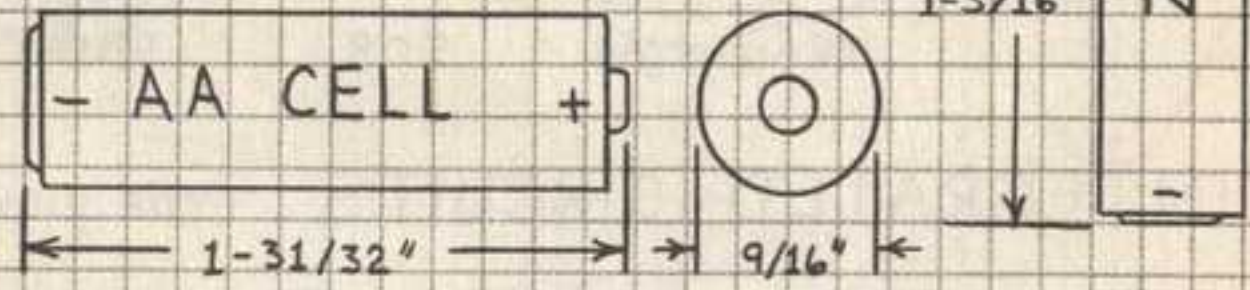
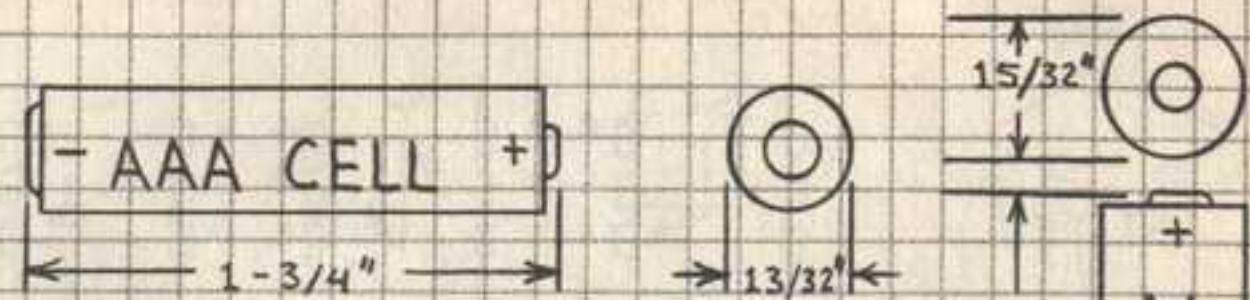

26

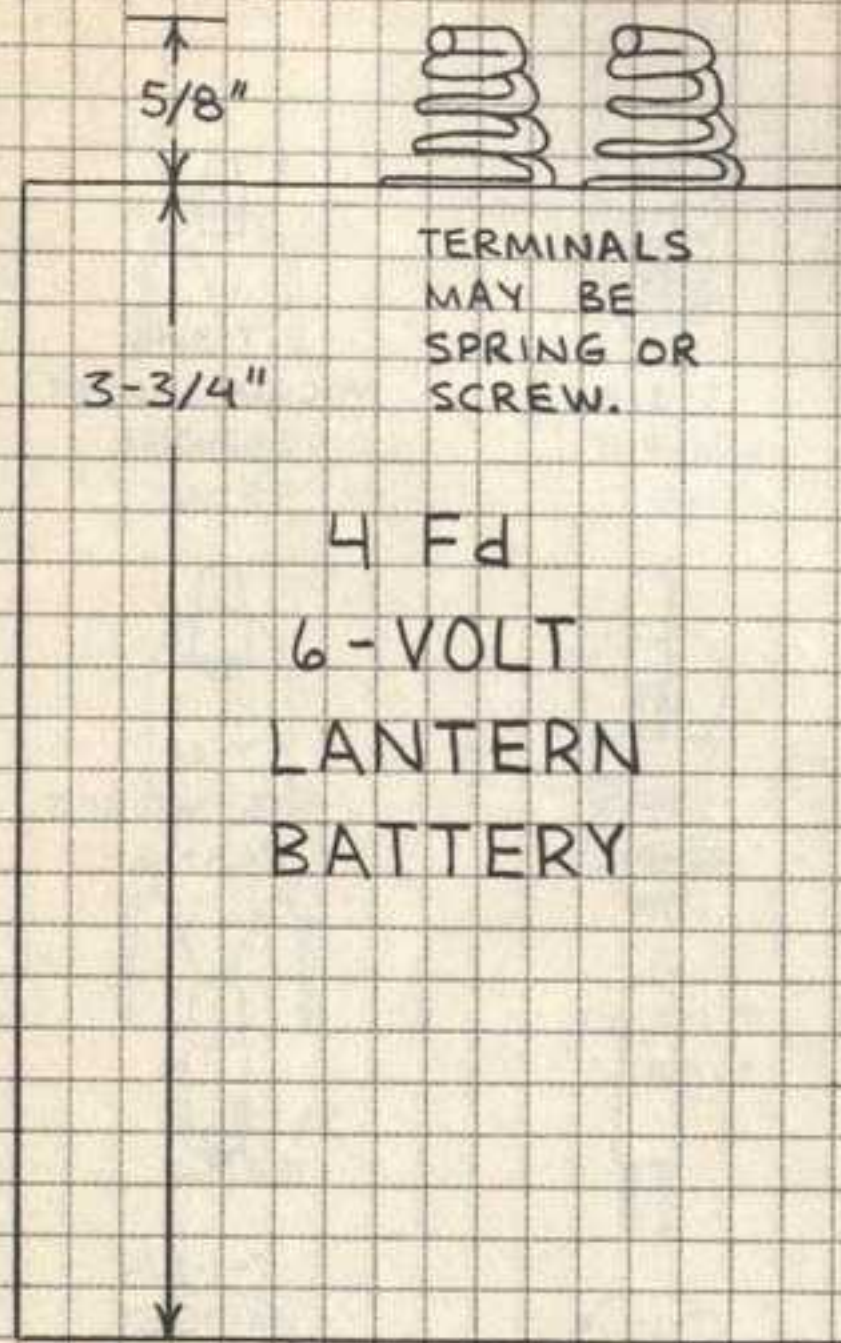

TERMINALS  
MAY BE  
SPRING OR  
SCREW.

4 Fd  
6-VOLT  
LANTERN  
BATTERY

COMMON COIN  
AND BUTTON  
CELLS  
(CELL THICKNESS  
VARIES WITH  
TYPE AND  
CHEMICAL  
COMPOSITION):

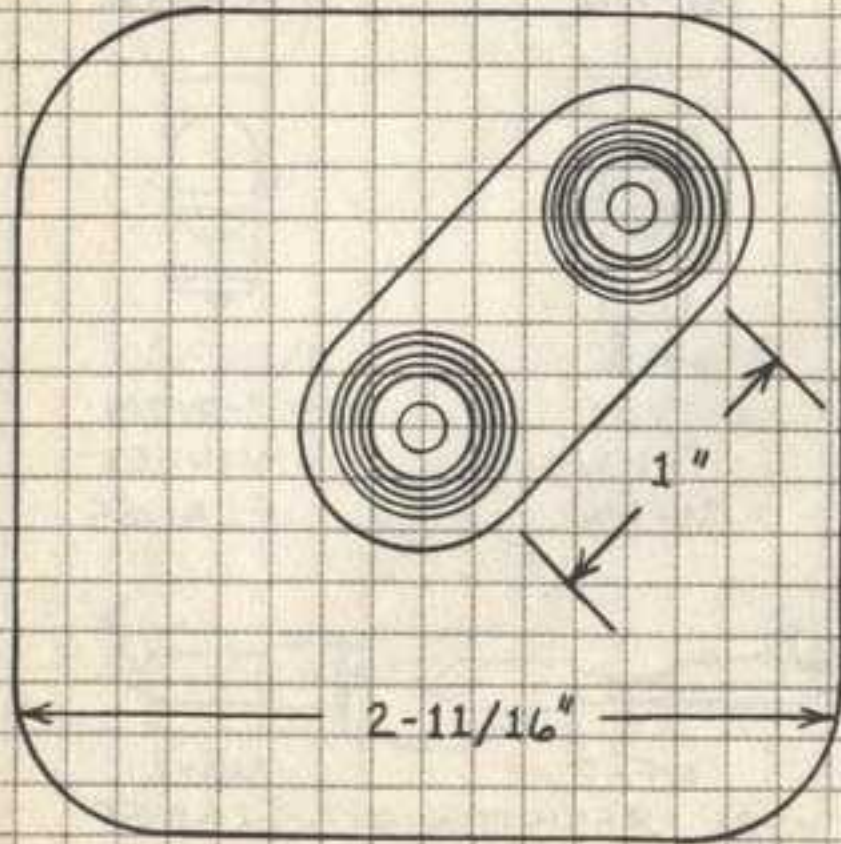
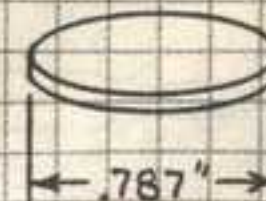
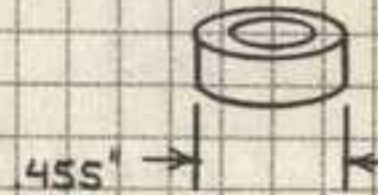
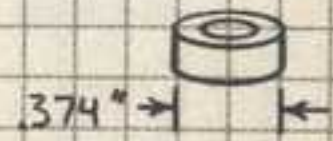
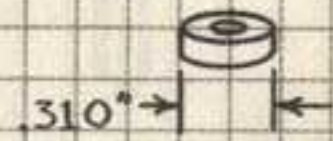
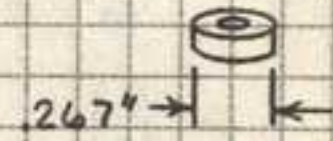

27



# LAMPS



T-3/4  
WIRE



T-3/4  
BI-PIN



T-3/4  
MICRO-MIDGET  
FLANGE

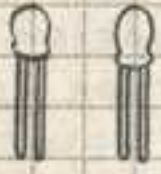

T-1  
WIRE



T-1  
BI-PIN



T-1  
SUB-MIDGET  
FLANGE



T-1-1/4  
WIRE



T-1-1/4  
BI-PIN

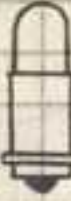

T-1-1/4  
MIDGET  
FLANGE



T-1-3/4  
WIRE



T-1-3/4  
BI-PIN



T-1-3/4  
MIDGET  
FLANGE



NE-2  
WIRE



NE-2  
WIRE + RESISTOR

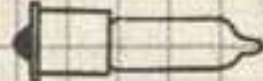

NE-2  
FLANGE

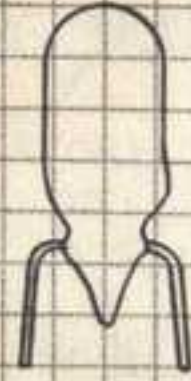

T-3-1/4  
WIRE



T-3-1/4  
SCREW



T-3-1/4  
BAYONET

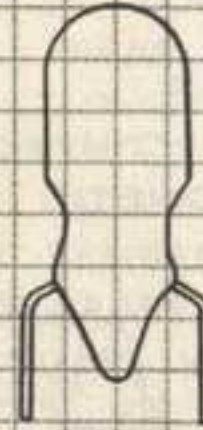

G-3-1/2  
WIRE

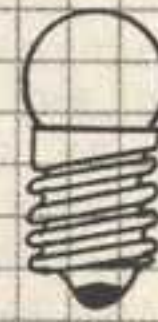

G-3-1/2  
SCREW



G-3-1/2  
BAYONET



G-4-1/2  
BAYONET



G-4-1/2  
SCREW

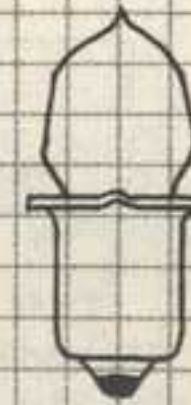

B-3-1/2  
FLANGE

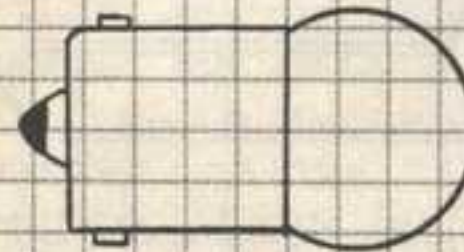

G-6 BAYONET

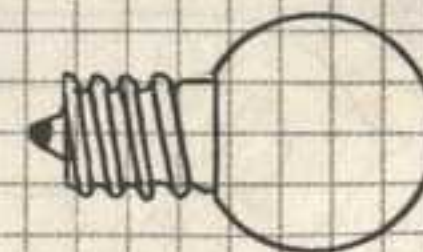

G-6 SCREW



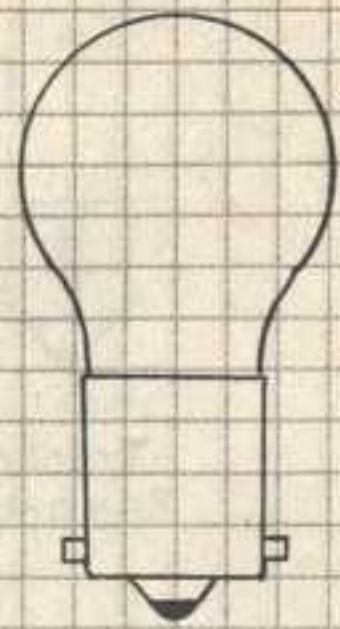

S-8  
SINGLE CONTACT  
BAYONET

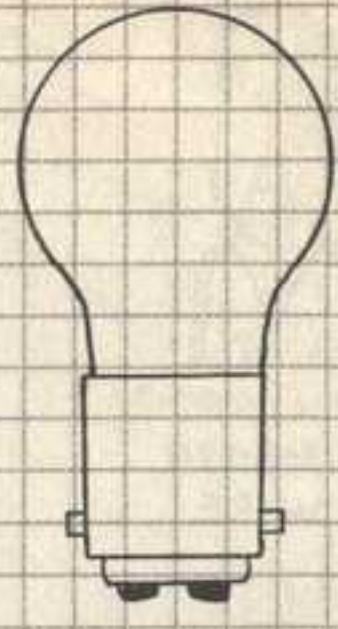

S-8  
DOUBLE CONTACT  
BAYONET



T-4  
HALOGEN

CAUTION: BULB MAY  
SHATTER. OBSERVE  
SAFETY PRECAUTIONS  
ON PACKAGE.



TL-3  
SCREW  
PRE-FOCUS

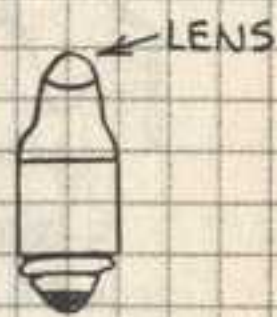

TL-2-3/4  
SPECIAL  
THREAD  
PRE-FOCUS

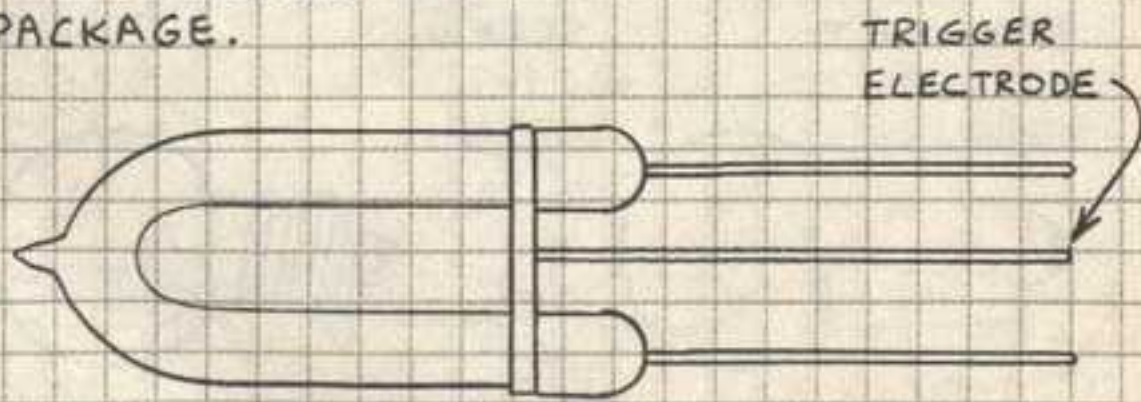

XENON FLASH LAMP

### 3. COMPONENT HANDLING

1. STORE COMPONENTS AT ROOM TEMPERATURE IN A DRY, DUST-FREE PLACE, PREFERABLY IN THE ORIGINAL PACKAGE.

2. AVOID DROPPING COMPONENTS. A FALL TO THE FLOOR SUBJECTS EVEN THE SMALLEST DEVICE TO MANY TIMES THE FORCE OF GRAVITY. A DROPPED DEVICE MAY APPEAR UNDAMAGED, BUT THE FORCE OF IMPACT MAY SEPARATE INTERNAL CONNECTIONS AND FORM TINY MICROCRACKS IN THE FUNCTIONAL PART OF THE DEVICE OR ITS PROTECTIVE COVERING OR COATING. CRACKS IN THE FUNCTIONAL PART OF THE DEVICE MAY RENDER IT USELESS, ALTER ITS SPECIFICATIONS OR DEGRADE ITS PERFORMANCE. CRACKS IN THE COATING WEAKEN THE DEVICE AND PERMIT THE ENTRY OF MOISTURE.



3. AVOID OVERHEATING COMPONENTS WHEN SOLDERING OR DESOLDERING. PROTECT HEAT SENSITIVE COMPONENTS WITH A SOLDERING HEAT SINK OR PLIERS. COOL THESE COMPONENTS BY BLOWING ON THEM, BUT NOT THE CONNECTION, AFTER SOLDERING.

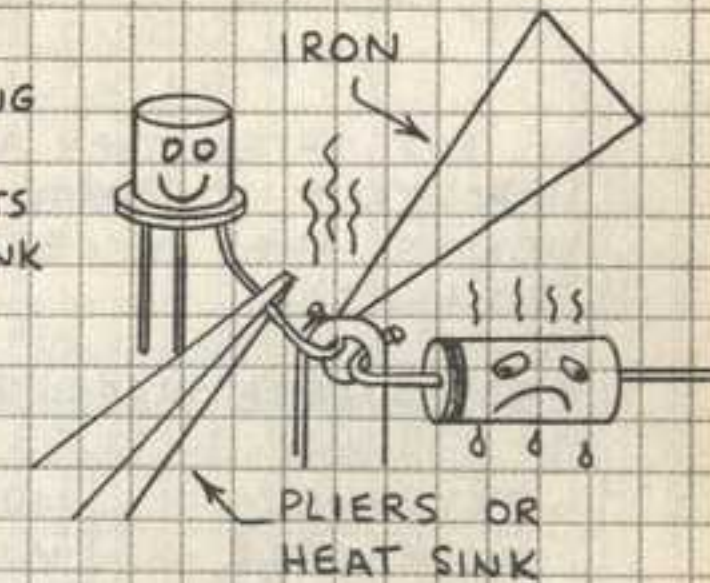

4. TO BEND A COMPONENT LEAD, GRASP THE LEAD WITH LONG NOSE PLIERS NEAR THE DEVICE AND THEN BEND THE LEAD WITH A FINGER. THE RADIUS OF THE BEND SHOULD EXCEED THE DIAMETER OF THE LEAD. BENDING LEADS WITHOUT PLIERS MAY FORM CRACKS BETWEEN LEAD AND DEVICE.

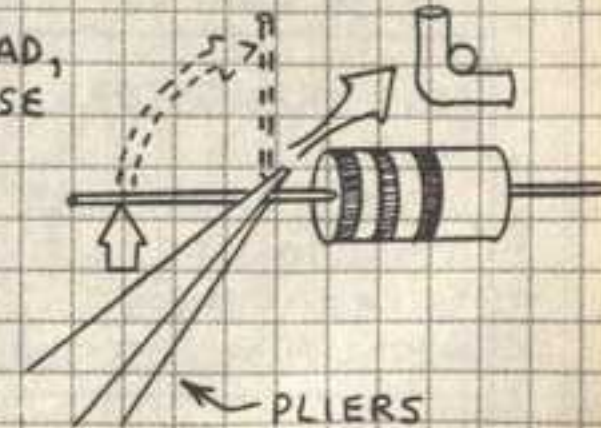



# ELECTROSTATIC DISCHARGE

IT IS WELL KNOWN THAT MOS (METAL-OXIDE-SEMICONDUCTOR) COMPONENTS CAN BE DAMAGED BY ELECTROSTATIC DISCHARGE (ESD). WHAT IS LESS WELL KNOWN IS THAT MANY OTHER COMPONENTS CAN ALSO BE DAMAGED BY ESD. COMPONENTS SUSCEPTIBLE TO DAMAGE FROM ESD ARE SOMETIMES MARKED WITH A WARNING LABEL...



... BUT OFTEN THEY ARE NOT. THEREFORE IT IS IMPORTANT TO KNOW WHICH KINDS OF COMPONENTS ARE SUSCEPTIBLE TO POSSIBLE DAMAGE FROM ESD.

ESD DAMAGE THRESHOLD OF CERTAIN COMPONENTS:

EXTREMELY VULNERABLE (1 TO 1,000 V)	MODERATELY VULNERABLE (1,000 TO 5,000 V)	SOMEWHAT VULNERABLE (5,000 TO 15,000 V)
MOS TRANSISTORS	CMOS ICs	TTL ICs
MOS ICs	LS TTL ICs	SMALL SIGNAL
$\mu$ WAVE TRANSISTORS	SCHOTTKY TTL ICs	DIODES AND
JUNCTION FETS	SCHOTTKY DIODES	TRANSISTORS
LASER DIODES	LINEAR ICs	PIEZOELECTRIC
METAL FILM RESISTORS		CRYSTALS

THIS IS ONLY A PARTIAL LISTING. WHEN DOUBT EXISTS, TREAT SUSPECT DEVICES AS ESD SENSITIVE.

TYPICAL ESD VOLTAGE GENERATED BY VARIOUS MATERIALS (75°F., 60% RELATIVE HUMIDITY):

MATERIAL	ACTION	VOLTAGE
RUBBER COMB	STROKE DRY HAIR	-2,500
DESK CHAIR	ROLL ACROSS PLASTIC FLOOR MAT	-2,000
POLYETHYLENE BAG	CRUMPLE IN HAND	-300
TO-92 TRANSISTORS IN POLY BAG	SHAKE BAG SEVERAL TIMES	-200
PENCIL ERASER	RUB ACROSS CIRCUIT BOARD	+100
PLASTIC PARTS BOX	RUB WITH 100% COTTON FABRIC	+100
CLEAN PLASTIC TAPE (2" WIDE)	RAPIDLY UNROLL SEVERAL INCHES	+500
ADULT MALE (RUBBER SOLE SHOES)	WALK ACROSS CARPET	-1,000

THESE MEASUREMENTS MADE WITH COMMERCIAL STATIC METER. ESD VOLTAGE IS FROM 10 TO 50 TIMES HIGHER WHEN RELATIVE HUMIDITY IS 10 TO 20%.

TYPICAL ESD DAMAGE TO GATE OF MOS FET:





## ESD HANDLING PRECAUTIONS

OBSERVE THE FOLLOWING PRECAUTIONS WHEN HANDLING COMPONENTS SUSCEPTABLE TO DAMAGE FROM ESD:

1. STORE COMPONENTS IN ORIGINAL PACKAGES, ELECTRICALLY CONDUCTIVE CONTAINERS OR CONDUCTIVE PLASTIC FOAM.
2. DO NOT TOUCH LEADS OR PINS.
3. DISCHARGE THE STATIC CHARGE ON YOUR BODY, BEFORE TOUCHING COMPONENTS, BY TOUCHING A GROUNDED METAL SURFACE (CABINET, APPLIANCE, ETC.).
4. PLACE COMPONENTS ON AN ALUMINUM FOIL SHEET OR TRAY OR ON CONDUCTIVE FOAM AFTER REMOVING THEM FROM THEIR CONTAINERS PRIOR TO INSTALLING THEM.
5. DO NOT SLIDE COMPONENTS ACROSS A WORK BENCH OR OTHER SURFACE.
6. KEEP STATIC-GENERATING MATERIALS (C.G. PLASTIC, CELLOPHANE, CANDY WRAPPERS, PAPER, CARDBOARD, ETC.) AWAY FROM WORK AREA.
7. NEVER ALLOW CLOTHING TO MAKE CONTACT WITH COMPONENTS.
8. NEVER INSTALL ESD-SENSITIVE COMPONENTS IN A CIRCUIT WHEN POWER IS APPLIED, AND NEVER REMOVE COMPONENTS FROM A CIRCUIT WHEN POWER IS APPLIED.
9. WHEN POSSIBLE, USE A BATTERY-POWERED IRON TO MAKE SOLDER CONNECTIONS TO ESD-SENSITIVE COMPONENTS. AN AC-POWERED IRON MAY BE USED IF THE TIP DOES NOT CARRY STRAY VOLTAGE.

34

## 4. COMPONENT TESTING

ALTHOUGH COMPONENTS CONNECTED IN A CIRCUIT CAN BE TESTED, BETTER RESULTS ARE OBTAINED BY TESTING COMPONENTS NOT INSTALLED IN A CIRCUIT. SUGGESTED METHODS INCLUDE:

RESISTORS - MEASURE RESISTANCE WITH A MULTIMETER.

CAPACITORS - DISCHARGE CAPACITOR BY SHORTING LEADS. THEN CONNECT AN ANALOG MULTIMETER SET TO HIGHEST RESISTANCE RANGE ACROSS CAPACITOR. (BE SURE TO OBSERVE POLARITY OF ELECTROLYTIC CAPACITORS.) METER NEEDLE SHOULD MOVE TO RIGHT AND THEN FALL BACK TO INITIAL POINT. NEEDLE WILL MOVE MORE WITH LARGE VALUE CAPACITORS. IT MAY NOT MOVE WHEN VALUE IS BELOW  $0.01 \mu\text{F}$ . IF NEEDLE REMAINS AT OR NEAR RIGHT SIDE OF METER, THE CAPACITOR IS SHORTED. IF NEEDLE FAILS TO MOVE, VALUE OF CAPACITOR IS BELOW  $0.01 \mu\text{F}$  OR CAPACITOR IS OPEN.

DIODES - USE A MULTIMETER. RESISTANCE SHOULD BE LOW IN FORWARD DIRECTION AND HIGH IN REVERSE DIRECTION.

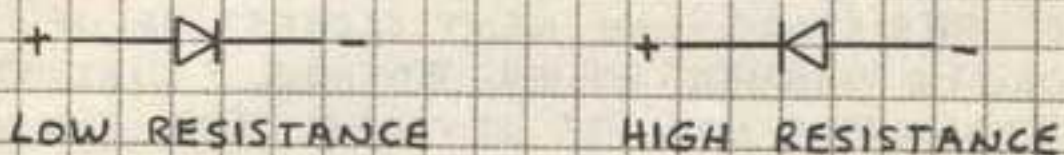

TRANSISTORS - THIS CIRCUIT PROVIDES A "GO/NO-GO" TEST FOR SWITCHING TRANSISTORS. RESPECTIVE LED GLOWS IF TRANSISTOR IS GOOD.

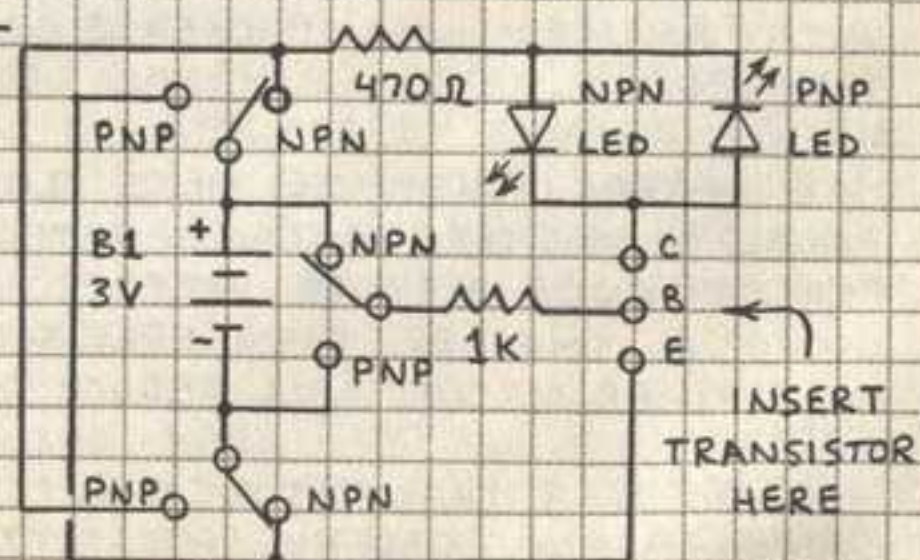

35



## 5. CIRCUIT DESIGN TIPS

1. USE EXISTING CIRCUITS AS BUILDING BLOCKS TO FORM ENTIRELY NEW CIRCUITS.

2. ALWAYS REVIEW THE MANUFACTURER'S SPECIFICATIONS FOR ACTIVE DEVICES (TRANSISTORS, INTEGRATED CIRCUITS, ETC.) BEFORE USING THEM IN A CIRCUIT. PAY PARTICULAR ATTENTION TO OPERATING VOLTAGES, INPUT AND OUTPUT REQUIREMENTS AND POTENTIAL PROBLEMS (SUCH AS OSCILLATION, NOISE, LATCHUP, ETC.).

3. BYPASS CAPACITORS, WHILE NOT ALWAYS REQUIRED, CAN PREVENT NOISE AND OSCILLATION IN ANALOG CIRCUITS AND FALSE TRIGGERING AND MEMORY LOSS IN DIGITAL CIRCUITS. IN ANALOG CIRCUITS PLACE A  $0.1\mu\text{F}$  AND  $1.0\mu\text{F}$  CAPACITOR ACROSS BATTERY LEADS WHERE THEY ENTER THE CIRCUIT BOARD. USE  $0.1\mu\text{F}$  CAPACITORS FROM POWER SUPPLY PINS OF OPERATIONAL AMPLIFIERS TO GROUND. IN DIGITAL CIRCUITS PLACE A  $0.1\mu\text{F}$  CAPACITOR ACROSS THE POWER SUPPLY PINS OF EACH CHIP.

4. COMPONENT SUBSTITUTION IS GENERALLY OKAY. HERE ARE SOME GENERAL GUIDELINES:

a. RESISTORS—USE NEXT CLOSEST VALUE. USE EQUAL OR HIGHER POWER RATING. CIRCUIT PERFORMANCE MAY BE ALTERED. FOR EXAMPLE, A SMALLER THAN SPECIFIED RESISTOR IN SERIES WITH AN LED WILL INCREASE CURRENT THROUGH THE LED.

b. CAPACITORS—USE NEXT CLOSEST VALUE. USE EQUAL OR HIGHER VOLTAGE RATING. CIRCUIT PERFORMANCE MAY BE ALTERED. FOR EXAMPLE, USING A SMALLER THAN SPECIFIED CAPACITOR IN A TIMER CIRCUIT WILL REDUCE THE TIMING CYCLE.

c. BIPOLAR TRANSISTORS—SUBSTITUTE WITHIN SAME FAMILY. OBSERVE POLARITY AND POWER.

36

## 6. CIRCUIT LAYOUT TIPS

1. CONNECTIONS BETWEEN COMPONENTS SHOULD BE AS SHORT AS POSSIBLE IN HIGH-SPEED DIGITAL CIRCUITS AND HIGH-FREQUENCY ANALOG CIRCUITS.

2. THE INPUT AND OUTPUT SECTIONS OF HIGH-GAIN AMPLIFIERS SHOULD BE PHYSICALLY ISOLATED FROM ONE ANOTHER. OTHERWISE INDUCTANCE BETWEEN THE INPUT AND OUTPUT WIRING MAY CAUSE A PORTION OF THE OUTPUT SIGNAL TO BE FED BACK TO THE INPUT. THE RESULT WILL BE SEVERE OSCILLATION.

3. POWER TRANSISTORS, ICs AND SOME OTHER COMPONENTS THAT BECOME WARM DURING OPERATION OFTEN PERFORM BETTER WITH A HEAT SINK. THEREFORE, LEAVE SPACE AROUND SUCH COMPONENTS FOR A HEAT SINK. AVOID PLACING HEAT SENSITIVE COMPONENTS NEAR COMPONENTS THAT MAY BECOME HOT.

4. USE INSULATED WIRE FOR INTERCONNECTIONS. INSULATE EXPOSED COMPONENT LEADS MOUNTED CLOSE TO OTHER EXPOSED LEADS OR HARDWARE.

5. ALL LEADS THAT CARRY HOUSEHOLD LINE CURRENT MUST BE INSULATED.

6. CIRCUITS IN WHICH A CURRENT FLOW IS SUDDENLY SWITCHED OFF OR ON MAY EMIT RADIO FREQUENCY RADIATION THAT CAN CAUSE SIGNIFICANT INTERFERENCE IN NEARBY RADIOS AND TELEVISIONS. RADIO FREQUENCY EMISSION CAN BE REDUCED BY ENCLOSING THE ENTIRE CIRCUIT IN A GROUNDED METAL ENCLOSURE. EXTERNAL CONNECTIONS TO OR FROM THE ENCLOSURE SHOULD BE MADE WITH SHIELDED CABLES.

7. USE STRANDED WIRE FOR ALL CONNECTIONS THAT ARE NOT FIXED IN POSITION (BATTERY CLIP LEADS, ETC.). USE SOLID WIRE FOR FIXED CONNECTIONS.

37



## 7. HEATSINKING

HEAT IS PRODUCED WHEN AN ELECTRICAL CURRENT FLOWS THROUGH A COMPONENT OR A CONDUCTOR. MOST COMPONENTS ARE SPECIFIED FOR OPERATION WITHIN A GIVEN TEMPERATURE RANGE. A HEATSINK WILL HELP REMOVE EXCESS HEAT FROM A COMPONENT. THERE ARE THREE PRIMARY MEANS BY WHICH HEAT LEAVES A COMPONENT:

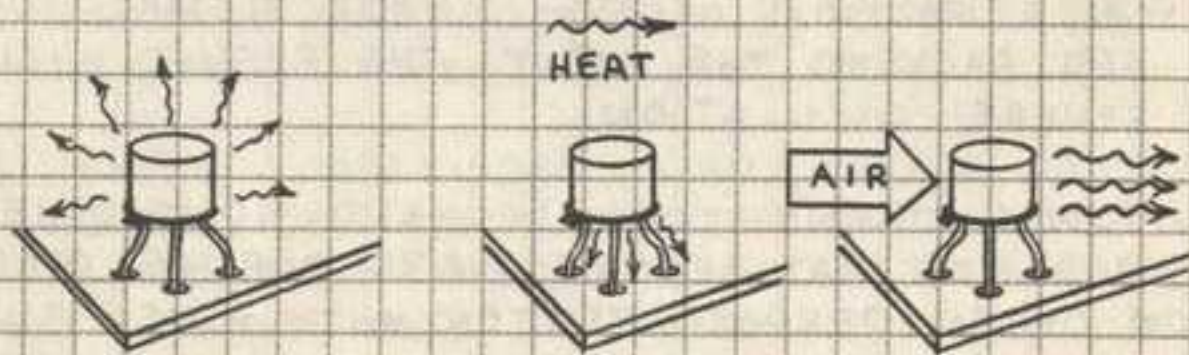

### RADIATION

HEAT IS RADIATED INTO SPACE AS ELECTROMAGNETIC RADIATION.

### CONDUCTION

HEAT IS CONDUCTED AWAY THROUGH DEVICE LEADS.

### CONVECTION

HEAT IS CONDUCTED INTO SURROUNDING AIR AND WAFTED AWAY.

HEATSINKS ARE METAL STRUCTURES THAT IMPROVE THE EFFICIENCY WITH WHICH HEAT LEAVES A COMPONENT. THE THERMAL CONDUCTIVITY OF VARIOUS MATERIALS IS COMPARED BELOW:

MATERIAL	CONDUCTIVITY (RELATIVE TO SILVER)	
DIAMOND (II)	5.4	
WATER	1.4	
SILVER	1.0	ALUMINUM IS THE MOST COMMON HEAT SINK MATERIAL.
COPPER	93	NOTE THAT COPPER IS NEARLY AS GOOD AS SILVER.
GOLD	74	
ALUMINUM	56	
NICKEL	21	
IRON	19	
TIN	16	
MICA	0.014	
AIR	0.00085	

38

A HEATSINK WILL PERMIT A DEVICE SUCH AS A POWER SEMICONDUCTOR TO DISSIPATE AS MUCH AS TEN TIMES OR MORE HEAT THAN OTHERWISE. A HEATSINK WILL ALSO INCREASE A DEVICE'S RELIABILITY AND LIFETIME.

THE INTERFACE BETWEEN A HEATSINK AND A COMPONENT IS NOT PERFECTLY FLAT. THEREFORE A THERMALLY CONDUCTIVE PAD OR FILM OF SILICONE GREASE MUST BE PLACED BETWEEN THE HEATSINK AND THE DEVICE:

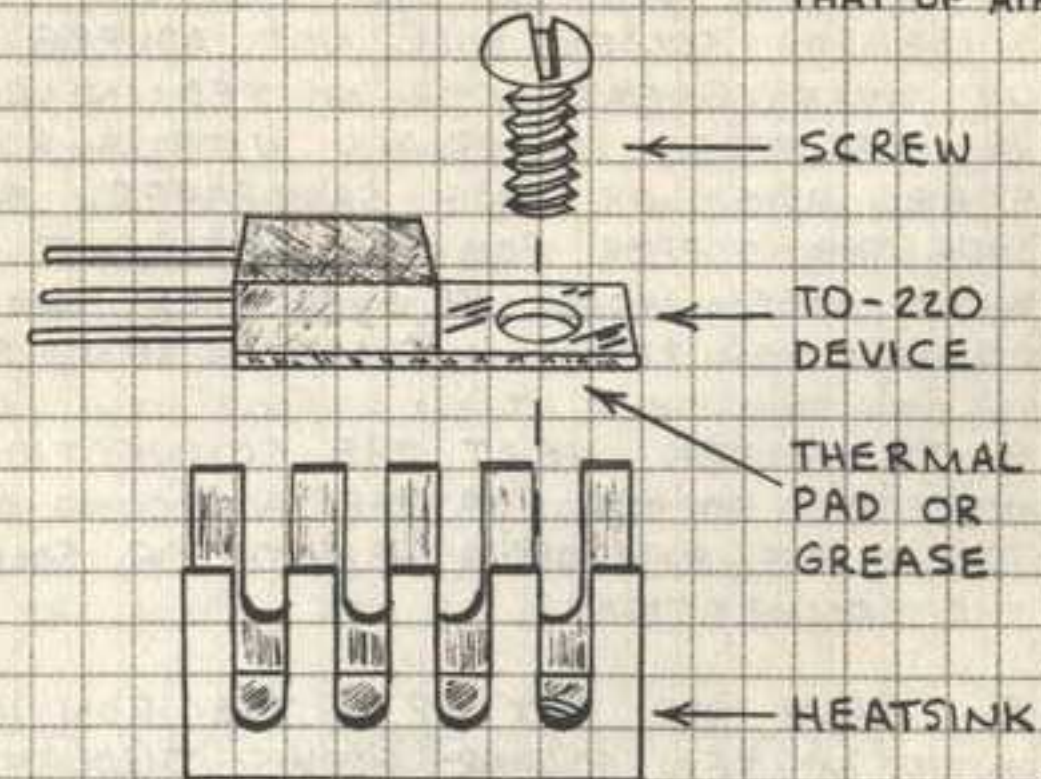
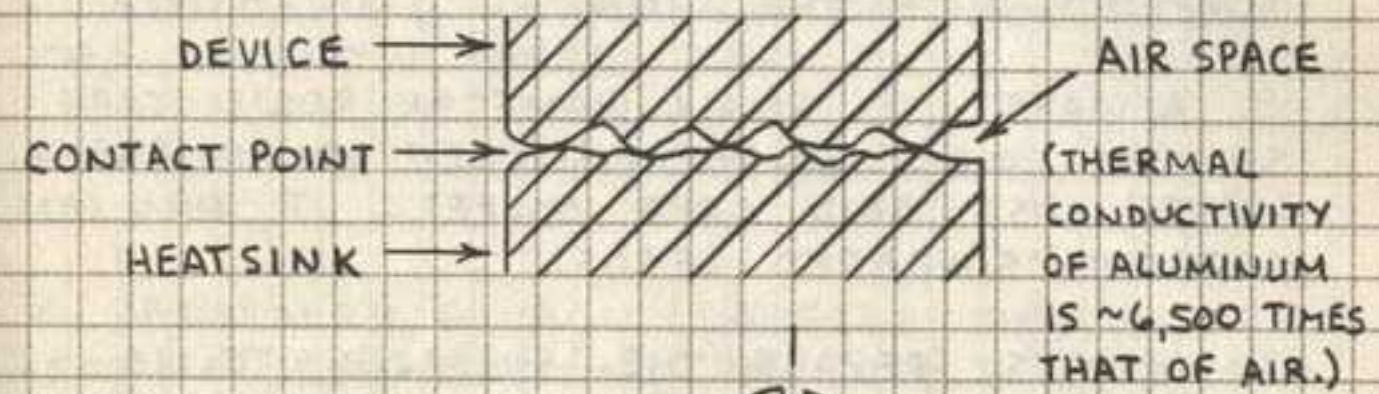

TYPICAL HEATSINK INSTALLATION

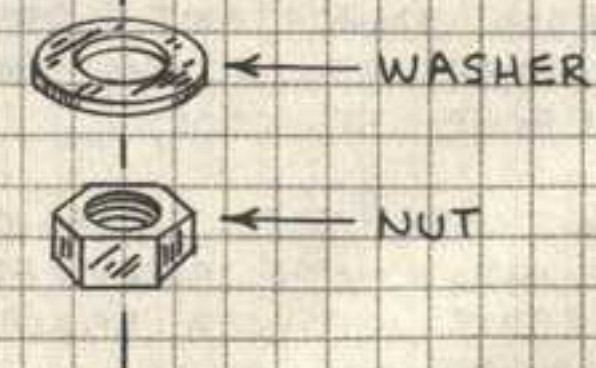

39



## 8. SOLDERING

FOLLOW THESE STEPS TO PRODUCE SUCCESSFUL SOLDER CONNECTIONS:

1. ELECTRONIC COMPONENTS AND CIRCUIT BOARDS CAN BE DAMAGED BY EXCESSIVE HEAT. THEREFORE, WHEN SOLDERING COMPONENTS TO A BOARD, ALWAYS USE A LOW-WATTAGE SOLDERING IRON (15 TO 40 WATTS). BE SURE TO TIN THE TIP ACCORDING TO THE INSTRUCTIONS SUPPLIED WITH THE IRON.
2. ALWAYS USE SMALL DIAMETER ROSIN CORE SOLDER WHEN SOLDERING ELECTRONIC PARTS. NEVER USE ACID CORE SOLDER. IT WILL CORRODE SOLDERED LEADS.
3. ALWAYS PREPARE THE SURFACES TO BE SOLDERED. SOLDER WILL NOT ADHERE TO PAINT, OIL, WAX, GREASE OR MELTED INSULATION. REMOVE THESE MATERIALS WITH A SOLVENT, STEEL WOOL OR FINE SANDPAPER. ALWAYS BUFF THE COPPER FOIL OF A CIRCUIT BOARD WITH STEEL WOOL. BE SURE THERE IS A GOOD CONNECTION BETWEEN SURFACES BEING SOLDERED.
4. TO SOLDER, HEAT THE CONNECTION FIRST, NOT THE SOLDER. AFTER A SECOND OR TWO TOUCH THE END OF A LENGTH OF SOLDER TO THE CONNECTION.
5. LEAVE THE HOT TIP OF THE IRON IN PLACE UNTIL MOLTEN SOLDER FLOWS THROUGH AND AROUND THE CONNECTION. THEN REMOVE THE IRON. IMPORTANT: DO NOT APPLY TOO MUCH SOLDER OR ALLOW THE CONNECTION TO MOVE BEFORE IT COOLS.
6. KEEP THE TIP OF THE IRON CLEAN AND SHINY. WIPE AWAY EXCESS SOLDER AND DEBRIS WITH A DAMP SPONGE OR CLOTH.

40

## DESOLDERING

A COMPONENT CAN BE REMOVED FROM A BOARD BY HEATING ITS CONNECTIONS WITH A HOT SOLDERING IRON UNTIL THE SOLDER MELTS AND THEN PULLING ON THE LEADS UNTIL THE COMPONENT IS FREE. UNLESS SPECIALIZED DESOLDERING TIPS ARE USED, THIS METHOD IS SUITABLE ONLY FOR INDIVIDUAL WIRES OR COMPONENTS WITH TWO LEADS. TO REMOVE COMPONENTS WITH MULTIPLE LEADS OR PINS, A DESOLDERING IRON OR TOOL SHOULD BE USED. FOLLOW THESE STEPS:

1. HEAT THE CONNECTION UNTIL THE SOLDER MELTS.
2. DESOLDERING IRON - SQUEEZE BULB BEFORE HEATING CONNECTION; RELEASE BULB WHEN SOLDER MELTS.  
DESOLDERING TOOL - SQUEEZE BULB OR ACTUATE PLUNGER. WHEN SOLDER MELTS, TOUCH TIP OF TOOL TO SOLDER AND RELEASE BULB OR PLUNGER. REPEAT IF NECESSARY.  
DESOLDERING BRAID - PLACE BRAID OVER SOLDER CONNECTION. PRESS BRAID AGAINST CONNECTION WITH TIP OF IRON UNTIL SOLDER MELTS AND FLOWS INTO BRAID.
3. REPAIR BROKEN AND SEPARATED FOIL PATTERN. SPLICES CAN BE MADE BY SOLDERING SHORT LENGTHS OF WIRE ACROSS BREAKS.

## SOLDERING PRECAUTIONS

1. A HOT SOLDERING IRON CAN CAUSE A FIRE OR BURN A FINGER. UNPLUG AN UNUSED SOLDERING IRON!
2. AVOID BREATHING SMOKE AND VAPOR FROM HOT SOLDER. SOLDER IN A WELL-VENTILATED AREA.
3. SUPERVISE CHILDREN WHO USE SOLDERING IRONS.

41



# HOW TO SOLDER

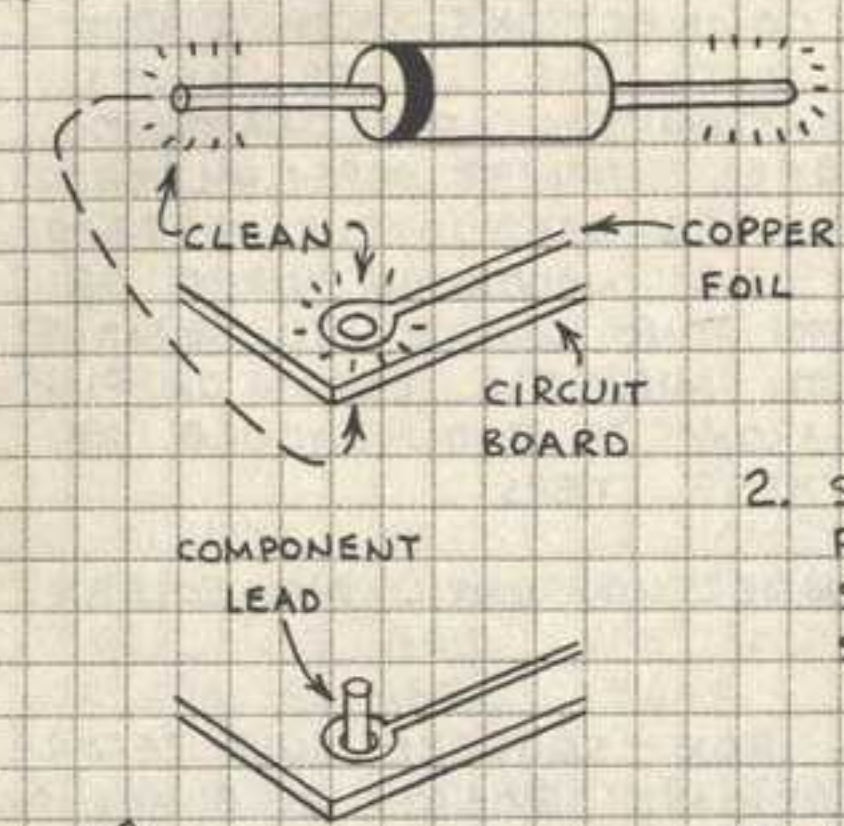

1. PREPARE THE SURFACES TO BE SOLDERED BY REMOVING ALL OXIDATION, GREASE, ADHESIVE AND PARTICLES.

2. SECURE IN FIXED POSITION THE SURFACES TO BE SOLDERED TOGETHER.

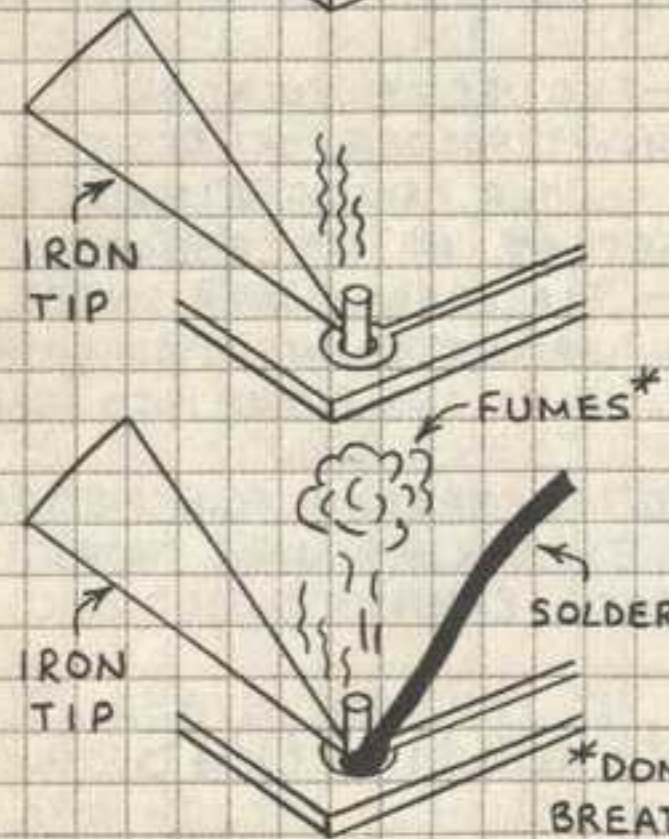

3. HEAT THE SURFACES TO BE SOLDERED FOR A FEW SECONDS WITH A HEATED SOLDERING IRON. HOLD THE IRON IN PLACE AND ...

4. ... TOUCH THE END OF A LENGTH OF ROSIN CORE SOLDER TO THE HEATED JUNCTION. ALLOW SOLDER TO MELT AND FLOW THROUGH AND OVER THE JUNCTION.

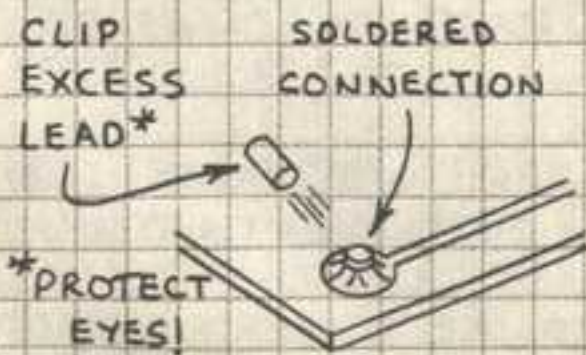

5. REMOVE THE IRON AND SOLDER AND ALLOW THE JUNCTION TO COOL BEFORE MOVING THE BOARD.

# HOW TO DESOLDER

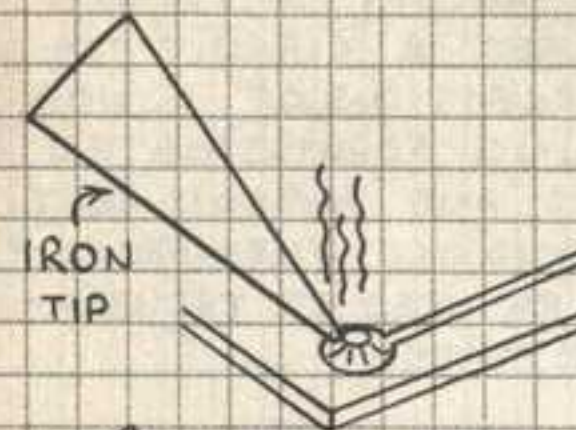

1. HEAT THE JUNCTION TO BE DESOLDERED WITH A HEATED SOLDERING IRON UNTIL THE SOLDER MELTS OR ...

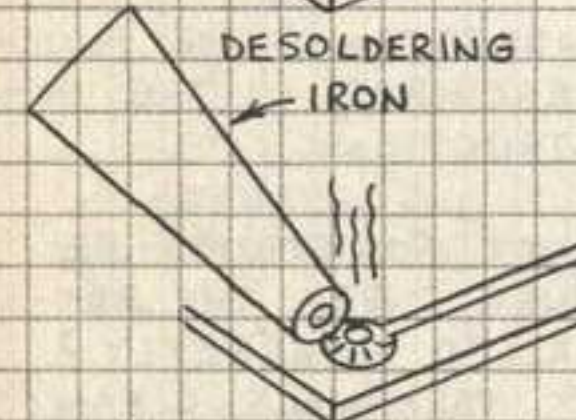

2. ... HEAT THE JUNCTION WITH A HEATED DESOLDERING IRON UNTIL THE SOLDER MELTS.

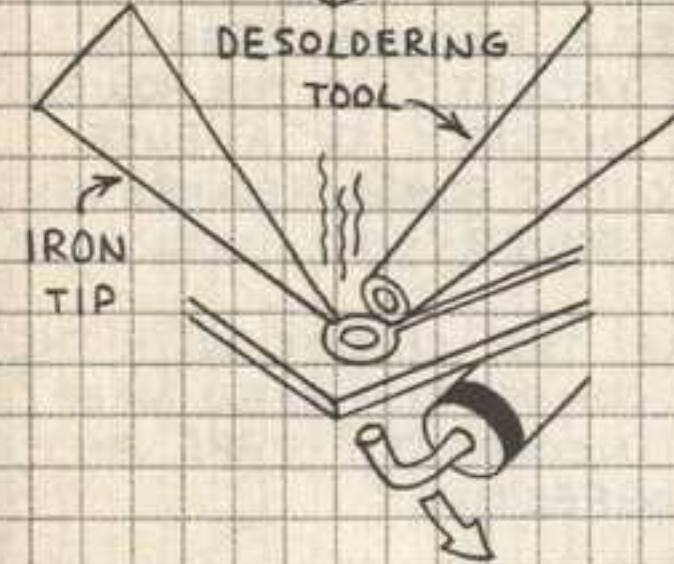

3. SQUEEZE THE BULB OF A DESOLDERING TOOL (OR IRON), PLACE TIP OF TOOL (OR IRON) AS CLOSE AS POSSIBLE TO SOLDER AND RELEASE BULB. SOLDER WILL BE SLURPED UP INTO TOOL. COMPONENT LEAD CAN NOW BE REMOVED. NOTE THAT LEAD CAN BE REMOVED BY PULLING ON IT WHEN SOLDER IS MOLTEN.



4. CLEAN TERMINAL.



5. REPAIR BROKEN FOIL PATTERN WITH WIRE BRIDGE. SOLDER IN PLACE.



## 9 TROUBLESHOOTING

TROUBLESHOOTING IS THE PROCESS OF IDENTIFYING THE PROBLEM THAT CAUSES A CIRCUIT TO MALFUNCTION. WITH THE EXCEPTION OF MINOR PROBLEMS, TROUBLESHOOTING SOPHISTICATED SYSTEMS LIKE COMPUTERS AND VCRS IS BEST LEFT TO QUALIFIED TECHNICIANS. THE PROCEDURES LISTED BELOW CAN BE USED TO TROUBLESHOOT DO-IT-YOURSELF PROJECTS:

1. BE SURE YOU FULLY UNDERSTAND THE FUNCTION OF THE CIRCUIT AS DESCRIBED IN THE INSTRUCTIONS FOR ITS CONSTRUCTION.

2. IF THE CIRCUIT DOES NOT FUNCTION, BE SURE IT IS RECEIVING POWER. ARE THE BATTERIES FRESH AND INSTALLED CORRECTLY? ARE THE BATTERY HOLDER'S TERMINALS CLEAN? HAS A BATTERY CLIP LEAD BECOME BROKEN INSIDE ITS INSULATING JACKET? IS THE POWER CORD INSERTED IN AN OUTLET? IS A FUSE BLOWN? DOES THE CIRCUIT'S POWER REQUIREMENT EXCEED THE AVAILABLE POWER?

3. CAREFULLY COMPARE THE CIRCUIT WITH THE SCHEMATIC. HAS EVERY CONNECTION BEEN MADE? ARE ANY CONNECTIONS INCORRECT? ARE ANY SOLDER CONNECTIONS DEFECTIVE?

4. ARE POLARITY-SENSITIVE COMPONENTS LIKE ELECTROLYTIC CAPACITORS, DIODES AND TRANSISTORS INSTALLED CORRECTLY? ARE INTEGRATED CIRCUITS INSTALLED CORRECTLY?

5. ARE UNUSED INPUTS OF DIGITAL LOGIC CHIPS CONNECTED TO GROUND OR ONE SIDE OF THE POWER SUPPLY?

6. FOR BEST RESULTS FOLLOW AN ORGANIZED, LOGICAL APPROACH TO TROUBLESHOOTING. THE TROUBLESHOOTING TREE ON THE FACING PAGE ILLUSTRATES THIS APPROACH.

44

## TROUBLESHOOTING TREE

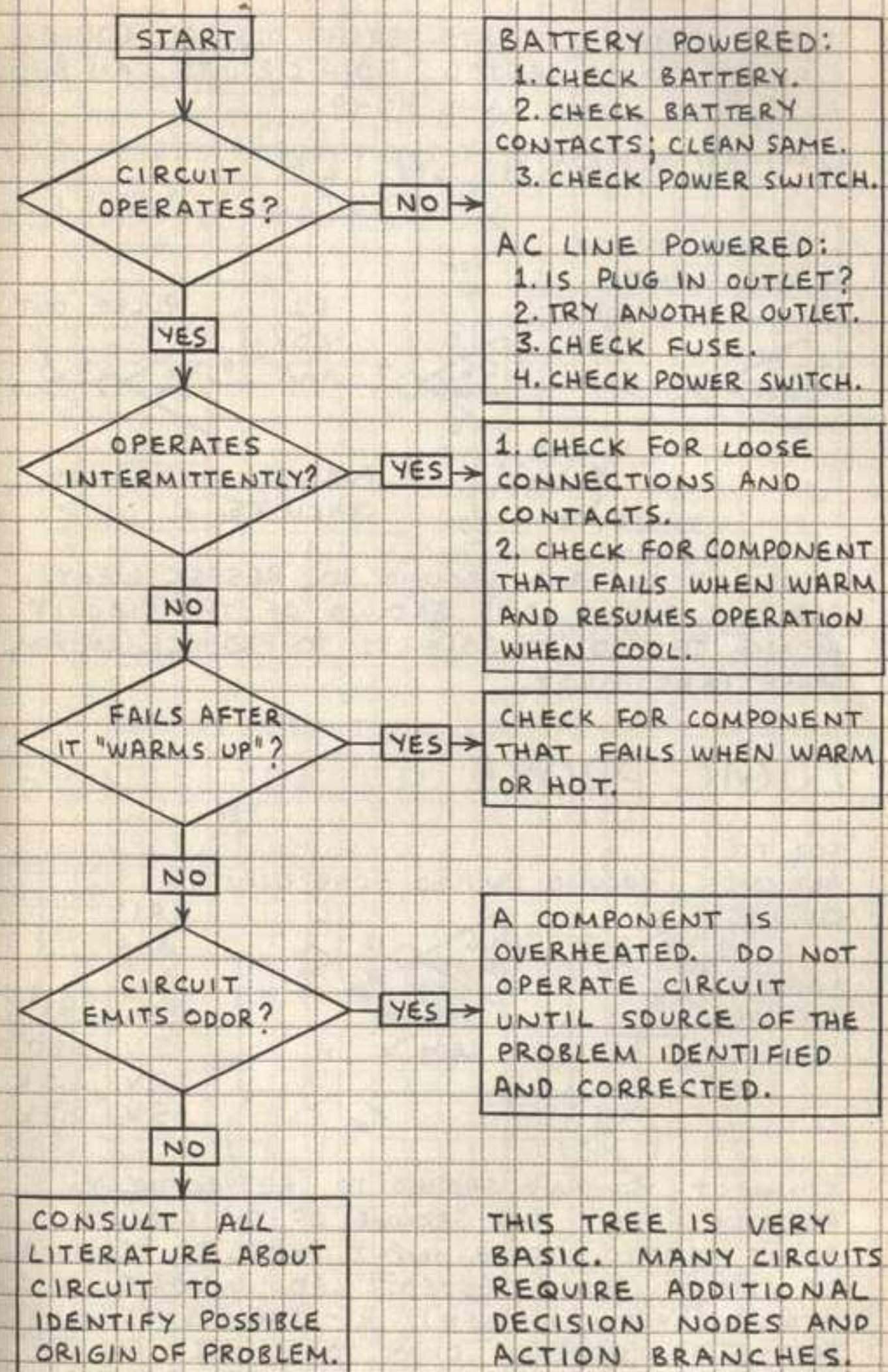

BATTERY POWERED:  
1. CHECK BATTERY.  
2. CHECK BATTERY CONTACTS; CLEAN SAME.  
3. CHECK POWER SWITCH.

AC LINE POWERED:  
1. IS PLUG IN OUTLET?  
2. TRY ANOTHER OUTLET.  
3. CHECK FUSE.  
4. CHECK POWER SWITCH.

1. CHECK FOR LOOSE CONNECTIONS AND CONTACTS.  
2. CHECK FOR COMPONENT THAT FAILS WHEN WARM AND RESUMES OPERATION WHEN COOL.

CHECK FOR COMPONENT THAT FAILS WHEN WARM OR HOT.

A COMPONENT IS OVERHEATED. DO NOT OPERATE CIRCUIT UNTIL SOURCE OF THE PROBLEM IDENTIFIED AND CORRECTED.

THIS TREE IS VERY BASIC. MANY CIRCUITS REQUIRE ADDITIONAL DECISION NODES AND ACTION BRANCHES.

45



## DIGITAL TROUBLESHOOTING

THESE SIMPLE CIRCUITS PERMIT DIGITAL LOGIC CIRCUITS TO BE TESTED. BOTH CIRCUITS CAN BE ASSEMBLED USING SAME 4049.

### BOUNCELESS SWITCH

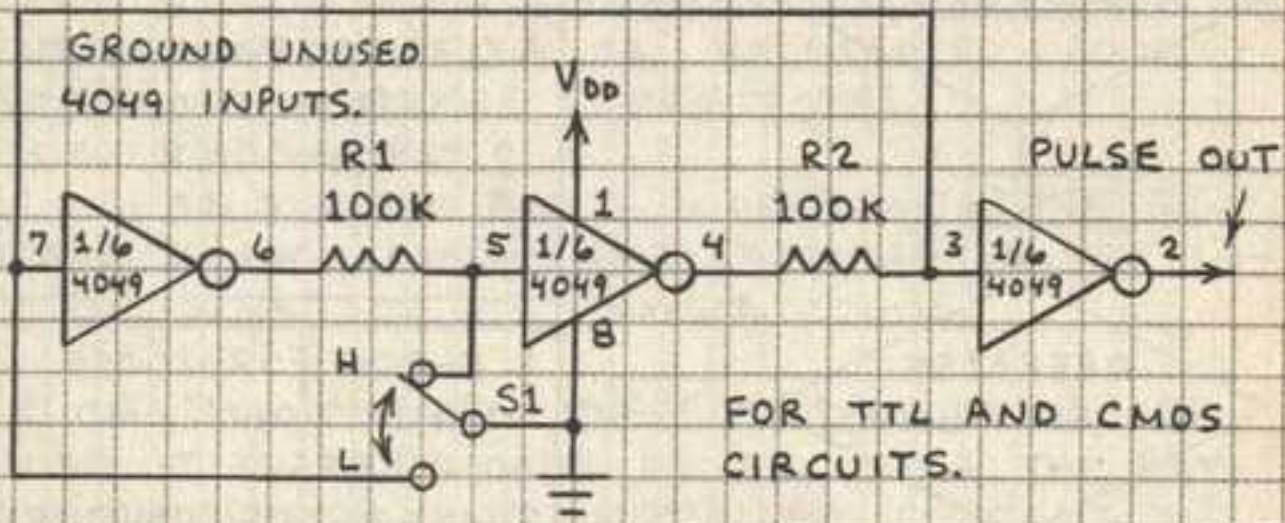

CONNECT  $V_{DD}$  AND GROUND TO, RESPECTIVELY, POSITIVE SUPPLY AND GROUND OF THE CIRCUIT BEING TESTED. TOGGLE  $S_1$  TO PRODUCE CLEAN, NOISE-FREE PULSE.

### LOGIC PROBE

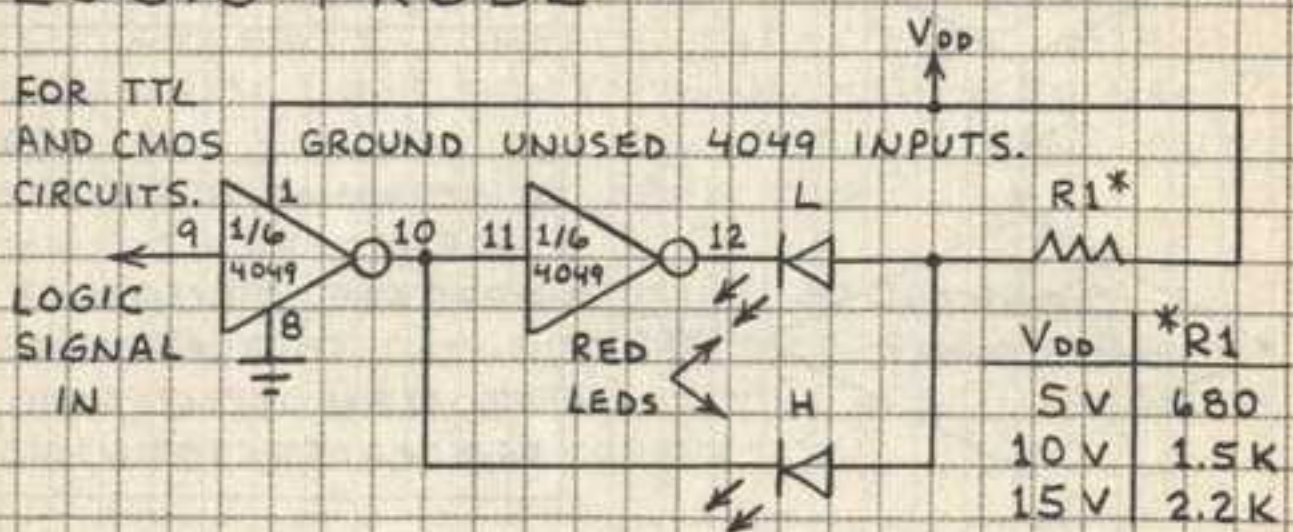

CONNECT  $V_{DD}$  AND GROUND TO, RESPECTIVELY, POSITIVE SUPPLY AND GROUND OF THE CIRCUIT BEING TESTED. TOUCH INPUT PROBE TO TERMINAL OF CIRCUIT BEING TESTED. LEDs INDICATE LOGIC STATUS (L=LOW; H=HIGH).  $R_1$ - TABLE GIVES VALUES FOR  $\sim 5$  mA CURRENT. OKAY TO USE 2.2K FOR ALL VALUES OF  $V_{DD}$  IF LEDs ARE SUPER-BRIGHT UNITS.

46

## ANALOG TROUBLESHOOTING

THESE CIRCUITS CAN BE USED TO TROUBLESHOOT AUDIO AMPLIFIERS AND TO DETERMINE THE CONTINUITY OF MULTI-CONDUCTOR WIRE AND CABLE. (SEE SAFETY PRECAUTIONS ON FOLLOWING PAGE.)

### SIGNAL INJECTOR

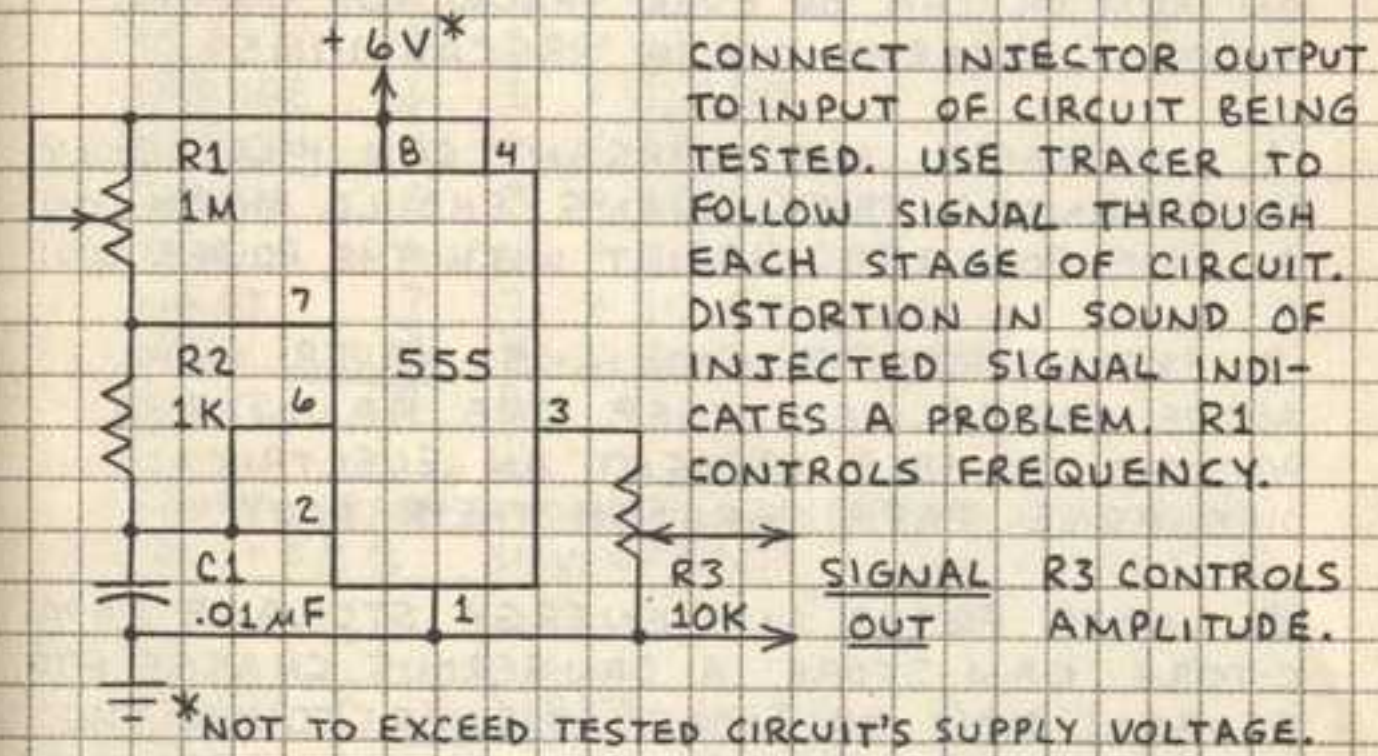

\*NOT TO EXCEED TESTED CIRCUIT'S SUPPLY VOLTAGE.

### SIGNAL TRACER

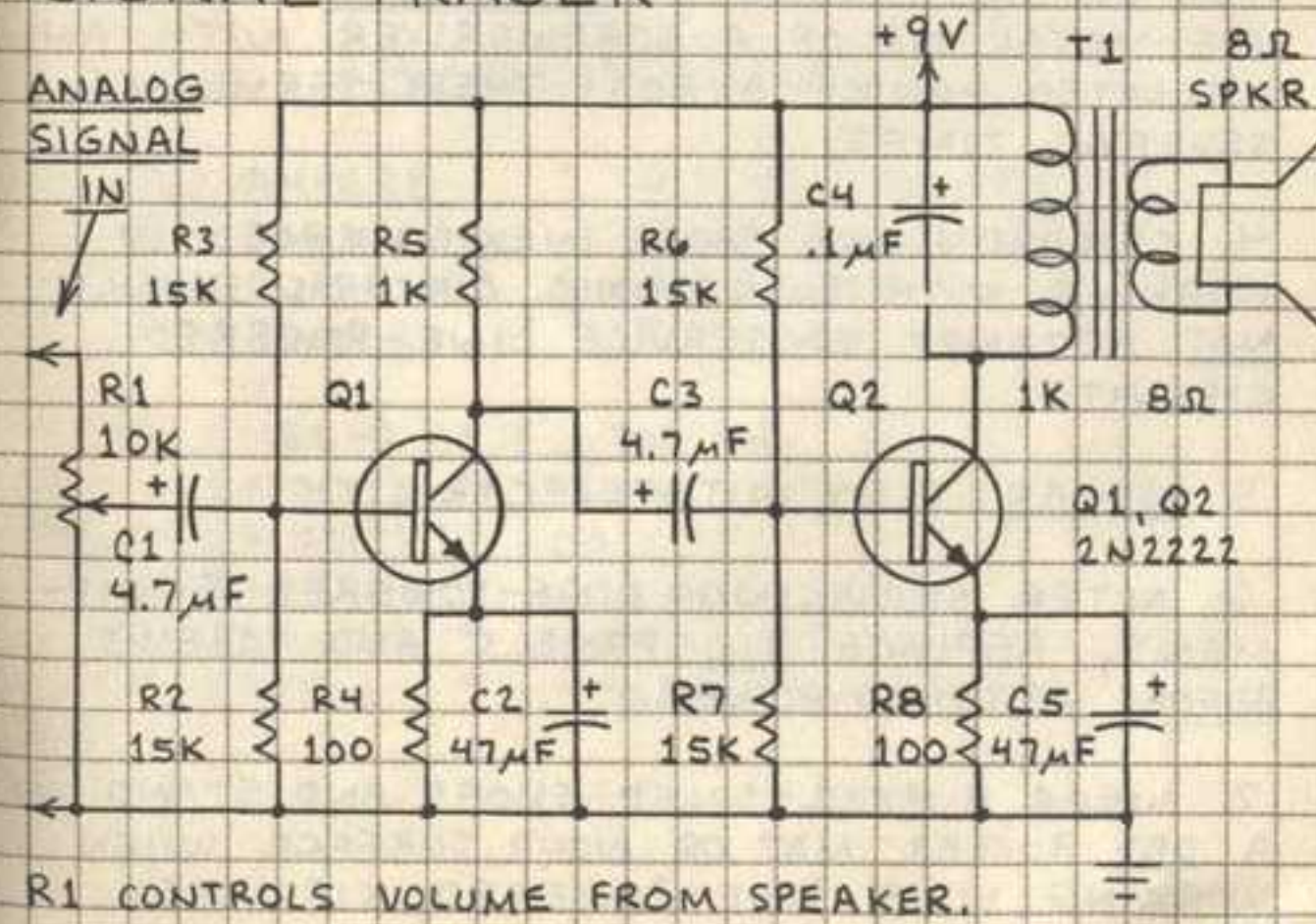

$R_1$  CONTROLS VOLUME FROM SPEAKER.

47



## 10. SAFETY PRECAUTIONS

ELECTRONIC CIRCUITS POWERED BY HOUSEHOLD LINE CURRENT AND SOME BATTERY-POWERED CIRCUITS CAN CAUSE DANGEROUS ELECTRICAL SHOCKS. AN ELECTRICAL SHOCK CAN CAUSE HEART FAILURE. A SHOCK CAN ALSO CAUSE A VIOLENT MUSCLE REFLEX THAT MAY INJURE AN ARM OR LEG OR EVEN THROW YOU TO THE FLOOR. OBSERVE THESE PRECAUTIONS:

1. HOUSEHOLD LINE CURRENT CAN KILL! ONLY EXPERIENCED TECHNICIANS SHOULD WORK ON A LINE-POWERED CIRCUIT WITH THE POWER ON!

2. EXPERIENCED TECHNICIANS NEVER WORK ALONE AND ALWAYS KEEP ONE HAND IN A POCKET TO HELP PREVENT AN ELECTRICAL DISCHARGE PATH THROUGH THEIR BODY.

3. LARGE FILTER AND ENERGY STORAGE CAPACITORS CAN STORE A DANGEROUS CHARGE FOR SEVERAL DAYS OR MORE! NEVER TOUCH THE TERMINALS OF SUCH CAPACITORS! CAPACITORS CAN BE DISCHARGED BY CAREFULLY TOUCHING THE METAL TIP OF A SCREWDRIVER WITH AN INSULATED HANDLE ACROSS THEIR TERMINALS SEVERAL TIMES.

4. CHILDREN AND THOSE INEXPERIENCED IN WORKING WITH ELECTRONIC CIRCUITS SHOULD NOT ATTEMPT TO SERVICE LINE-POWERED CIRCUITS!

5. NEVER PLAY WITH ELECTRICITY!

6. AFTER SERVICING LINE-POWERED EQUIPMENT, REPLACE ALL PANELS AND SCREWS BEFORE APPLYING POWER.

7. WEAR RUBBER-SOLED SHOES AND STAND ON A DRY RUBBER MAT OR WOOD SURFACE WHEN WORKING WITH LINE-POWERED CIRCUITS.

48

## RESISTOR COLOR CODE

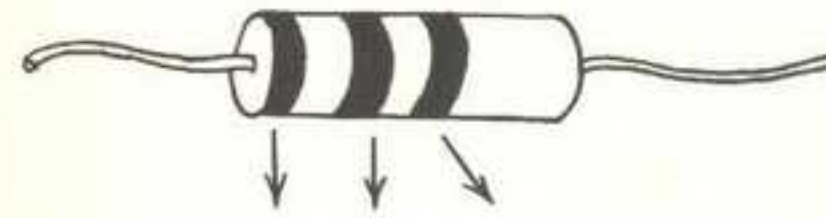

BLACK	0	0	x 1
BROWN	1	1	x 10
RED	2	2	x 100
ORANGE	3	3	x 1,000
YELLOW	4	4	x 10,000
GREEN	5	5	x 100,000
BLUE	6	6	x 1,000,000
VIOLET	7	7	x 10,000,000
GRAY	8	8	x 100,000,000
WHITE	9	9	—

FOURTH BAND INDICATES TOLERANCE (ACCURACY):  
GOLD = ±5%    SILVER = ±10%    NONE = ±20%

OHM'S LAW:  $V = IR$      $R = V/I$   
 $I = V/R$      $P = VI = I^2R$

## ABBREVIATIONS

A = AMPERE    R = RESISTANCE  
F = FARAD    V (OR E) = VOLT  
I = CURRENT    W = WATT  
P = POWER     $\Omega$  = OHM

M (MEG-) = x 1,000,000  
K (KILO-) = x 1,000  
m (MILLI-) = ,001  
 $\mu$  (MICRO-) = ,000 001  
n (NANO-) = ,000 000 001  
p (PICO-) = ,000 000 000 001