

**HALLICRAFTERS
MODEL S-38**

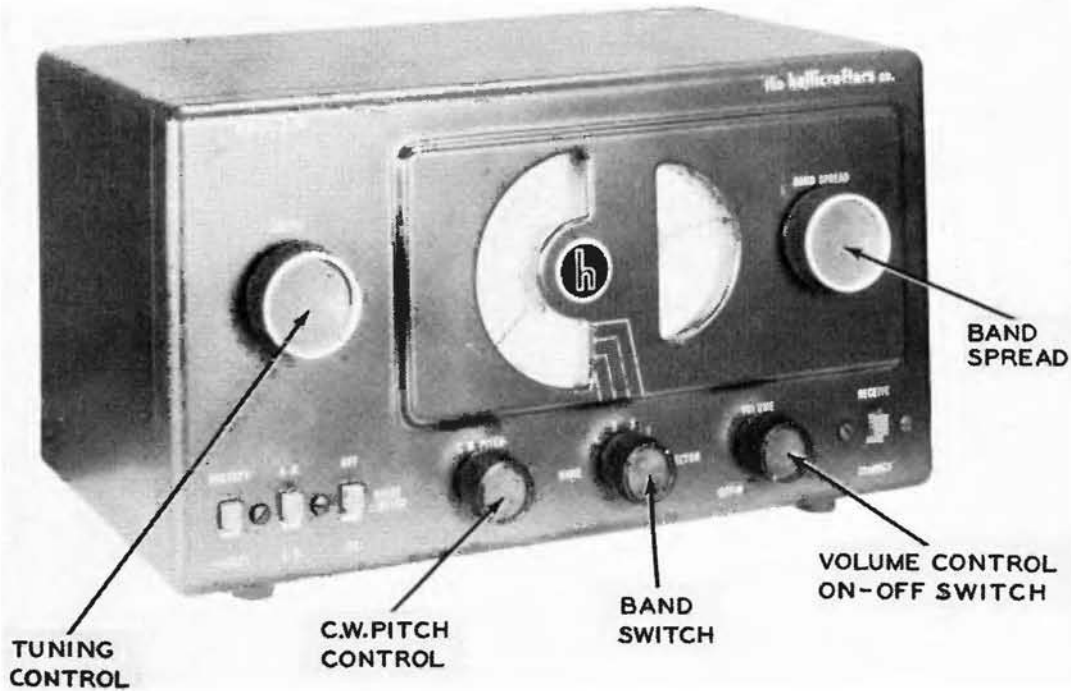

HALLICRAFTERS MODEL S-38

**HALLICRAFTERS
MODEL S-38**

TRADE NAME Hallcrafters Model S-38
 MANUFACTURER Hallcrafters Co., 2611 S. Indiana Ave., Chicago, Illinois
 TYPE SET AC - DC Superheterodyne - 4 Band Communications Receiver
 TUBES (SIX) Types 12SA7GT Converter, 12SK7GT 1 $\frac{1}{2}$ Amp., 12SQ7GT Det.-AVC-AF, 12SQ7GT BFO-ANL, 35L6GT Power Output, 35Z5GT Rectifier.
 POWER SUPPLY 105-125 Volts AC-DC Rating .245 Amps. @ 117 Volts AC
 TUNING RANGE Band #1- 540-1650KC Band #2- 1650KC-5.0MC Band #3 5.0MC-14.5 μ C Band #4- 13.5MC-32.0MC

ALIGNMENT INSTRUCTIONS

| DUMMY ANTENNA | SIGNAL GENERATOR COUPLING | SIGNAL GENERATOR FREQUENCY | BAND SWITCH POS. | RADIO DIAL SETTING | OUTPUT METER | ADJUST | REMARKS |
|--|--|----------------------------|------------------|--------------------|-------------------|---------------|---|
| NONE | High side to stator plates of rear section of tuning gang. Low side to "C" on antenna strip. | 455KC | "1" | 1000KC | Across voice coil | A1,A2, A3,A4. | Adjust for maximum output. Repeat adjustment. |
| " | " | " | " | " | " | BFO Slug | Turn off 400 Ω modulation on signal generator. Set CW/AM switch at CW. Remove pitch control knob and adjust slotted screw shaft for zero beat. |
| 390 Ω carbon res. | High side to "A1" on antenna strip. Low side to "G" on antenna strip. | 30 μ C | "4" | 30 μ C | " | A5,A6 | Adjust for maximum output. Rock gang slightly when adjusting A6. |
| " | " | 14MC | "3" | 14MC | " | A7,A8 | Adjust for maximum output. Rock gang slightly when adjusting A8. |
| " | " | 5MC | "2" | 5 μ C | " | A9 | Adjust for maximum output. |
| " | " | 1.8MC | " | 1.8MC | " | A10 | Adjust for maximum output and repeat A9 at 5 μ C. |
| " | " | 5MC | " | 5MC | " | A11 | Adjust for maximum output. Rock gang slightly. |
| " | " | 1500KC | "1" | 1500KC | " | A12 | Adjust for maximum output. |
| " | " | 600KC | " | 600KC | " | A13 | Adjust for maximum output and repeat A12 at 1500KC. |
| " | " | 1500KC | " | 1500KC | " | A14 | Adjust for maximum output. Rock Gang Slightly. |
| Set receiver controls as follows: "Speaker-Phones" switch at speaker; Volume control at full clockwise (maximum); CW/AM switch at "AM" (except for BFO adjustment); noise limiter switch at "off"; bandspread tuning at "0" (min. cap.); "standby-receive" switch at receive. Adjust output of signal generator no higher than is necessary to obtain output reading. Use insulated alignment screwdriver for adjusting. | | | | | | | |

HOWARD W. SAMS & CO., INC. • 2924 East Washington Street • Indianapolis 6, Indiana

"The listing of any available replacement part herein does not constitute in any case a recommendation, warranty or guaranty by Howard W. Sams & Co., Inc., as to the quality and suitability of such replacement part. The numbers of these parts have been compiled from information furnished to Howard W. Sams & Co., Inc., by the manufacturers of the particular type of replacement part listed."
 "Reproduction or use, without express permission, of editorial or pictorial con-

tent, in any manner, is prohibited. No patent liability is assumed with respect to the use of the information contained herein. Copyright 1946 by Howard W. Sams & Co., Inc., Indianapolis, Indiana, U. S. A. Copyright under International Copyright Union. All rights reserved under Inter-American Copyright Union (1910) by Howard W. Sams & Co., Inc."

PARTS LIST AND DESCRIPTIONS

TUBES

| ITEM No. | USE | REPLACEMENT DATA | | RMA BASE TYPE | INSTALLATION NOTES |
|----------|--------------|------------------------|----------------------|---------------|--------------------|
| | | HALLICRAFTERS PART No. | STANDARD REPLACEMENT | | |
| 1 | Converter | 12SA7GT | 6AD | | |
| 2 | IF Amp. | 12SK7GT | 6N | | |
| 3 | Det.-AVC-AF | 12SG7GT | 6C | | |
| 4 | BFO-ANL | 12SQ7GT | 6Q | | |
| 5 | Power Output | 35L6GT | 7AC | | |
| 6 | Rectifier | 35Z5GT | 6AD | | |

CAPACITORS

Capacity values given in the rating column are in mfd. for Electrolytic and Paper Capacitors, and in mmfd. for Mica and Ceramic Capacitors.

| ITEM No. | RATING CAP. | VOLT | REPLACEMENT DATA | | | | AEROVOX PART No. | CORNELL-DUBILIER PART No. | IDENTIFICATION CODES AND INSTALLATION NOTES |
|----------|-------------|------|------------------------|-----------------|----------------|------------------|------------------|---------------------------|---|
| | | | HALLICRAFTERS PART No. | MALLOY PART No. | SOLAR PART No. | SPRAGUE PART No. | | | |
| 7(A) | 40 | 150 | TC48 | TPB-40X30-150 | TA-430 | | EZ44315C | Filter - Red | |
| (B) | 30 | 150 | | | 20-38 | | | Filter - Yellow | |
| (C) | 30 | 150 | | | | | | | |
| (D) | 20 | 25 | | | | | | | |
| 8 | .25 | 200 | 46AT254J | TP430 | TC-25 | 494--25 | D74P25 | Cath. Bypass - Blue | |
| 9 | .02 | 400 | 46AW203J | TP423 | TC-12 | 494--02 | D74S2 | Line Isolating | |
| 10 | .02 | 600 | 46AY203J | TP412 | TC-12 | 694--02 | D76S2 | Line Bypass | |
| 11 | .01 | 400 | 46AW102J | TP421 | TC-11 | 494--01 | D74S1 | 35L6 Plate Bypass | |
| 12 | .005 | 400 | 46AW502J | TP408 | TC-25 | 494--005 | D76D5 | Audio Coupling | |
| 13 | .01 | 400 | 46AW102J | TP421 | TC-11 | 494--01 | D74S1 | BFO Plate Bypass | |
| 14 | .05 | 200 | 46AU503J | TP426 | TC-15 | 494--05 | D74S5 | IF Cath. Bypass | |
| 15 | .25 | 200 | 46AT254J | TP430 | TC-2 | 494--25 | D74P25 | Screen Bypass | |
| 16 | .02 | 400 | 46AW203J | TP423 | TC-12 | 494--02 | D74S2 | AVC Filter | |
| 17 | .05 | 200 | 46AV103J | TP410 | TC-11 | 494--01 | D76S1 | Ant. Coupling | |
| 18 | .05 | 200 | 46AV103J | TP410 | TC-15 | 494--05 | D74S5 | RF Bypass Pwr. Supp. | |
| 19 | 220 | 500 | CM202A22M | MC240 | MO.5-325 | 1468--00025 | S45T25 | RF Bypass Diode | |
| 20 | 220 | 500 | CM202A22M | MC240 | MO.5-325 | 1468--00025 | S45T25 | BFO Grid Cap. | |
| 21 | 470 | 500 | CM201A47M | MC245 | MO.5-35 | 1468--00035 | S45T35 | BFO Fixed Trimmer | |
| 22 | 2700 | 500 | CM30A27M | MC450 | MO.5-325 | 1467--00025 | S45T25 | RF Grid Cap. | |
| 23 | 220 | 500 | CM30A22M | MC440 | MO.5-325 | 1468--00025 | S45T25 | Fixed Padder | |
| 24 | 2700 | 500 | CM30A27M | MC450 | MO.5-325 | 1467--00025 | S45T25 | Osc. Grid Cap. | |
| 25 | 510 | 500 | CM20A51M | MC245 | MO.5-35 | 1468--00035 | S45T35 | RF Bypass Rect. | |
| 26 | 220 | 500 | CM20A22M | MC240 | MO.5-325 | 1468--00025 | S45T25 | Audio Plate Bypass | |
| 27 | 1200 | 500 | CM20A12M | MC255 | MO.3-21 | 1468--001 | LW5D1 | Fixed Trimmer | |

CONTROLS

| ITEM No. | RATING RESISTANCE | WATTS | REPLACEMENT DATA | | | INSTALLATION NOTES |
|----------|-------------------|-------|------------------------|-----------------|--------------|---|
| | | | HALLICRAFTERS PART No. | MALLOY PART No. | IRC PART No. | |
| 28(A) | 500K Ω | 1 | 25B094 | MP48 | D13-133 | Volume Control Attach to 28A per instructions. |
| (B) | Switch | | Not Req. | Not Req. | A | |
| (C) | Switch | | Not Req. | Not Req. | 41 | |

RESISTORS

| ITEM No. | RATING RESISTANCE | WATTS | REPLACEMENT DATA | | IDENTIFICATION CODES |
|----------|-------------------|-------|------------------------|--------------|-------------------------------|
| | | | HALLICRAFTERS PART No. | IRC PART No. | |
| 29 | 10K Ω | | RC20A10M | BTS-10K | Br.-Blk.-Or. Ant. Shunt |
| 30 | 470K Ω | | RC20A47M | BTS-470K | Yl.-Vl.-Yl. Converter Grid |
| 31 | 47K Ω | | RC20A47M | 5W-E-47 | Yl.-Vl.-Blk. Osc. Series Grid |
| 32 | 22K Ω | | RC20A22M | BTS-22K | Red-Red-Or. Osc. Grid |
| 33 | 2.2 Meg. | | RC20A22M | BTS-2.2 Meg. | Red-Red-Grn. AVC Network |
| 34 | 47K Ω | | RC20A47M | BTS-47K | Yl.-Vl.-Or. Diode Load |
| 35 | 47K Ω | | RC20A47M | BTS-47K | Yl.-Vl.-Br. CW AVC Shorting |
| 36 | 47K Ω | | RC20A47M | BTS-47K | Yl.-Vl.-Or. BFO Grid |
| 37 | 10 Meg. | | RC20A10M | BTS-10 Meg. | Br.-Blk.-blue 1st AF Grid |
| 38 | 220K Ω | | RC20A22M | BTS-220K | Red-Red-Yl. 1st AF Plate Load |
| 39 | 470K Ω | | RC20A47M | BTS-470K | Yl.-Vl.-Yl. Output Grid |
| 40 | 150K Ω | | RC20A15M | 5W-E-150 | Br.-Orn.-Br. Output Latch |
| 41 | 100K Ω | | RC20A10M | 5T-1000 | Br.-Blk.-Red Filter |
| 42 | 630K Ω | | RC30A63M | 5TA-38C | Blue-Gray-br. |

CHASSIS—TOP VIEW

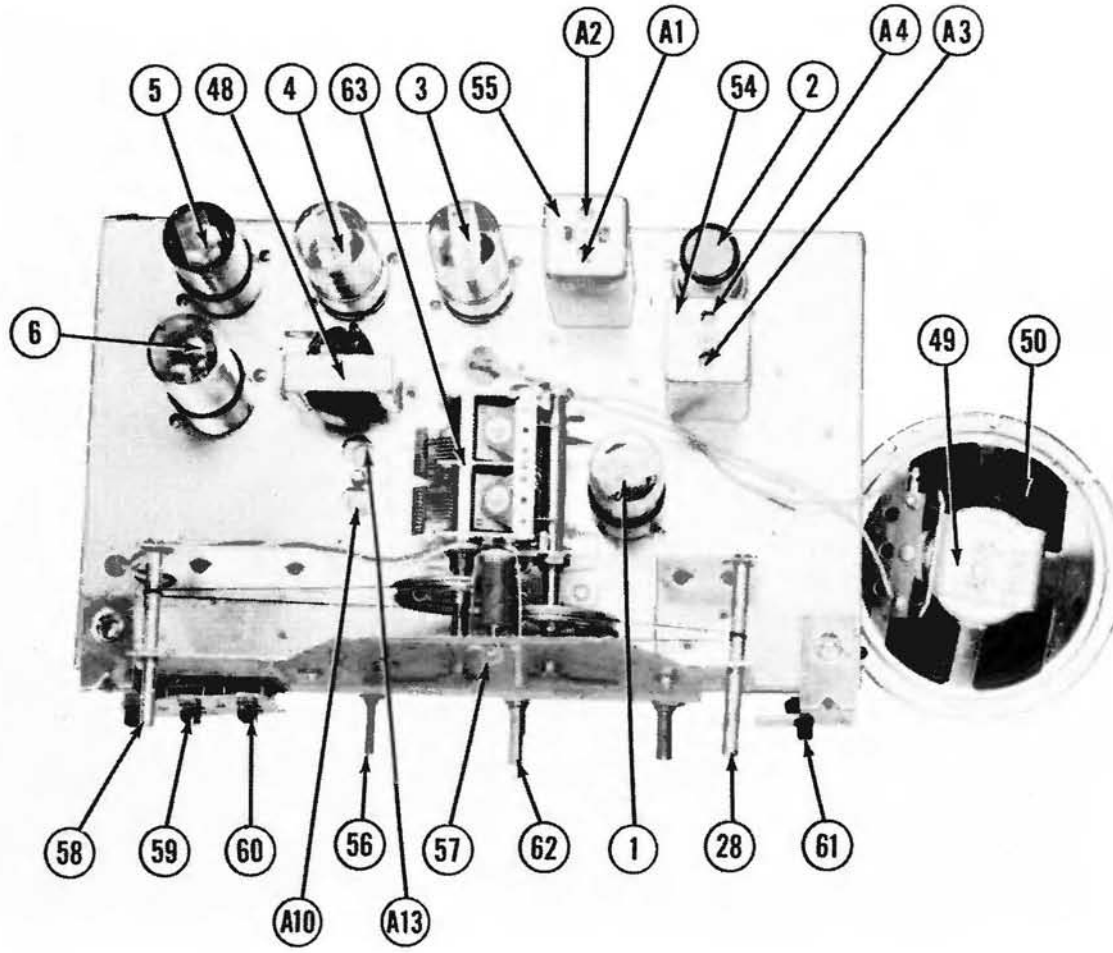

PARTS LIST AND DESCRIPTIONS (Continued)

RESISTORS (CONTINUED)

| | | | | |
|----|------|------------|----------|-------------------------------|
| 43 | 22Ω | RC20A2282M | 1W-1/2 | Red-Red-Blk. Surge Limiter |
| 44 | 330Ω | RC20A333M | 1/2W-1/2 | Or.-Or.-Br. Pilot Light Shunt |
| 45 | 15Ω | RC20A151CM | 1/2W-1/2 | Br.-Orn.-Blk. Headphone Shunt |
| 46 | 330Ω | RC20A3301K | 1/2W-1/2 | Or.-White-Br. IF Cathode |
| 47 | 470Ω | RC20A471K | 1/2W-1/2 | Yl.-Vl.-Er. 50 Plate Load |

TRANSFORMER (OUTPUT)

| ITEM No. | RATING | | REPLACEMENT DATA | | INSTALLATION NOTES |
|----------|-----------|---------|------------------------|--------------------|----------------------------|
| | IMPEDANCE | DC RES. | HALLICRAFTERS PART No. | THORPAR'N PART No. | |
| 48 | 3.15Ω | 3.1Ω | 58A075 | A-3873 | 1Drill new mounting holes. |

SPEAKER

| ITEM No. | RATINGS | REPLACEMENT DATA | | INSTALLATION NOTES |
|----------|--------------------|---|-----------------|--------------------|
| | | HALLICRAFTERS PART No. | JENSEN PART No. | |
| 49 | FIELD VC I/F. | 85C035 | ST-105 | |
| 50 | PHONE DIA. VC DIA. | NOT READILY REPLACABLE-USE COMPLETE SPEAKER UNIT. | | |

R F COILS

| ITEM No. | USE | DC RES. | | REPLACEMENT DATA | | INSTALLATION NOTES |
|----------|------------------|---------|-------|------------------------|-------------------|--|
| | | PRI. | SEC. | HALLICRAFTERS PART No. | MEISSNER PART No. | |
| 51 (A) | Band 1 Art. Coil | 20Ω | 4-5Ω | 51C621* | | *Wound on same coil form with bands 2,3,4. |
| 51 (B) | " | 10 | 10 | " | " | " |
| 51 (C) | " | 10 | 10 | " | " | " |
| 52 | " | 10 | 10 | " | " | " |
| 53 (A) | 1 Osc. | 5Ω | 5Ω | 51C618 | | **Wound on coil form with bands 2,3,4. |
| 53 (B) | " | 2 | 2 | 51C622** | | " |
| 53 (C) | " | 2 | 2 | " | " | " |
| 53 (D) | " | 2 | 2 | " | " | " |
| 54 | Input IF | 18 | 00 | 50C183 | 13-6658 | " |
| 55 | Output IF | 27Ω | 26-5Ω | 50B124 | 19-8660 | " |
| 56 | RF Osc. Coil | 24-8Ω | 24-8Ω | 54B031 | | " |

DIAL LIGHT

| ITEM No. | BASE TYPE | VOLTS | AMPS. | BEAD COLOR | REPLACEMENT DATA | | INSTALLATION NOTES |
|----------|-----------|-------|-------|------------|------------------------|--------------------|--------------------|
| | | | | | HALLICRAFTERS PART No. | THORPAR'N PART No. | |
| 57 | Bayonet | 5-8 | 0.15 | Brown | 39A034 | | Type 47 |

MISCELLANEOUS

| ITEM No. | PART NAME | HALLICRAFTERS PART No. | NOTES |
|----------|-----------------|------------------------|-------------------------------------|
| 58 | Switch | 60A243 | "SPEAKER-PHONES" SPST |
| 59 | " | 60A245 | "NO-CW" SPST |
| 60 | " | 60A244 | "NOISE LUTTER" SPST |
| 61 | " | 60A244 | "RECEIVE STANDBY" SPST |
| 62 | " | 50A240 | 4 Position Bandswitch |
| 63 | Tuning Cap. | 44C152 | 2 Gang Main & Band Spread Ver. Cap. |
| | Trimmer | 44B129 | AS, A7, A9, A12 Osc. Adjustments |
| | " | 44A039 | AS, All, A14 Art. Adjustments |
| | " | 44C152 | Antenna Trimmer |
| | " | 44B129 | A10, A13 Osc. Padders |
| A6 | Knob | 15A049 | Volume and Band Switch |
| | " | 15A065 | C.W. Pitch Control |
| | Calibrated Dial | 83B257 | Tuning and Bandspread Controls |
| | Dial Window | 225157 | Glass |

CHASSIS—BOTTOM VIEW

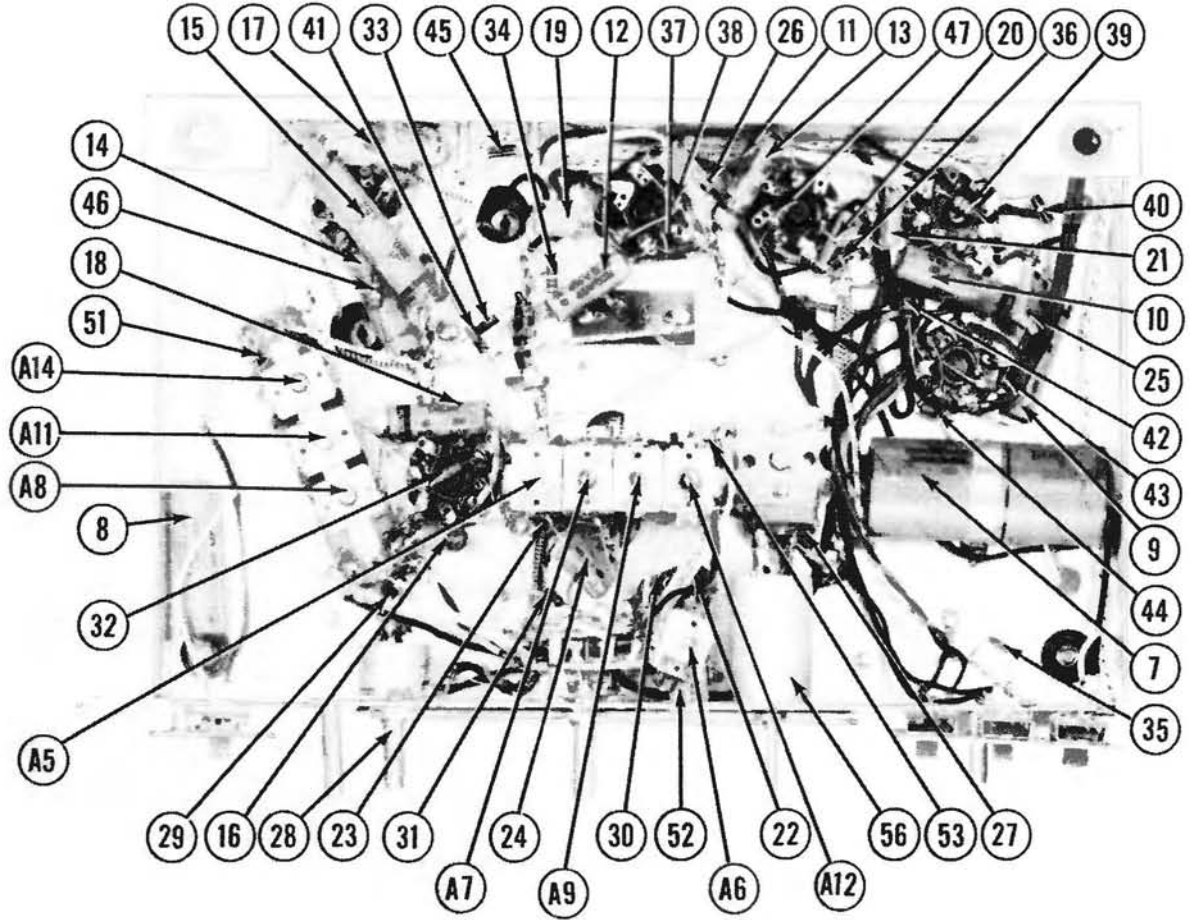

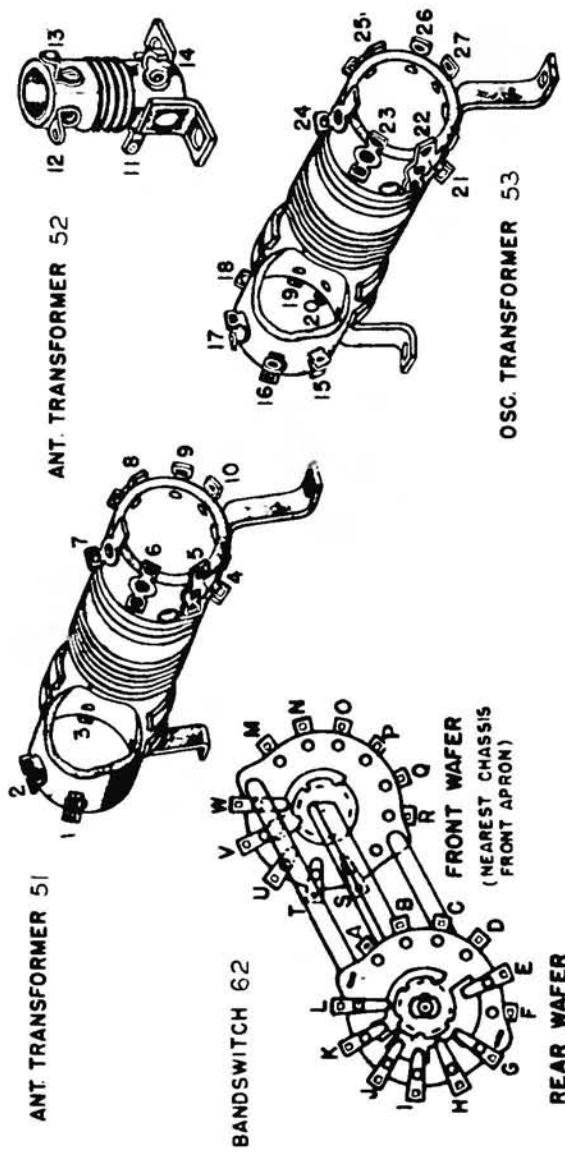

COIL CONNECTIONS

To restring the main tuning dial cord, cut a 14" length of 30 lb. test dial cord and tie one end of the tension spring of the main tuning capacitor drive pulley at position "1" on the diagram. Following the numbers 1 through 15, wind the cord on the pulley and knob drive shaft. At position "15," stretch the tension spring and tie the cord securely. Cut off the excess cord. Note that two complete turns are wound on the knob drive shaft.

To restring the bandsread tuning dial cord, cut a 16" length of dial cord and follow the procedure as explained above, except start at position "A" on the diagram and proceed through position "S". Note that the knob drive shaft has two complete turns.

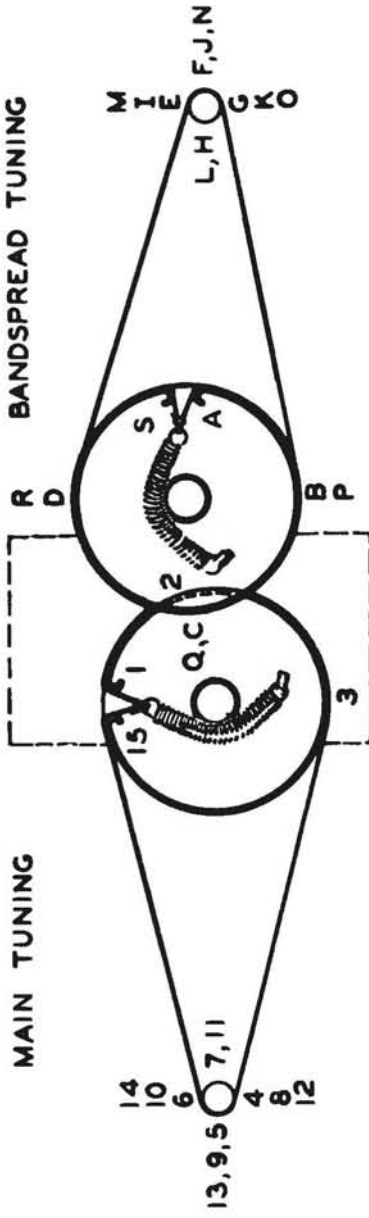

TUNING CAPACITOR FULLY CLOSED (BOTH SECTIONS).
DIAL STRINGING PROCEDURE

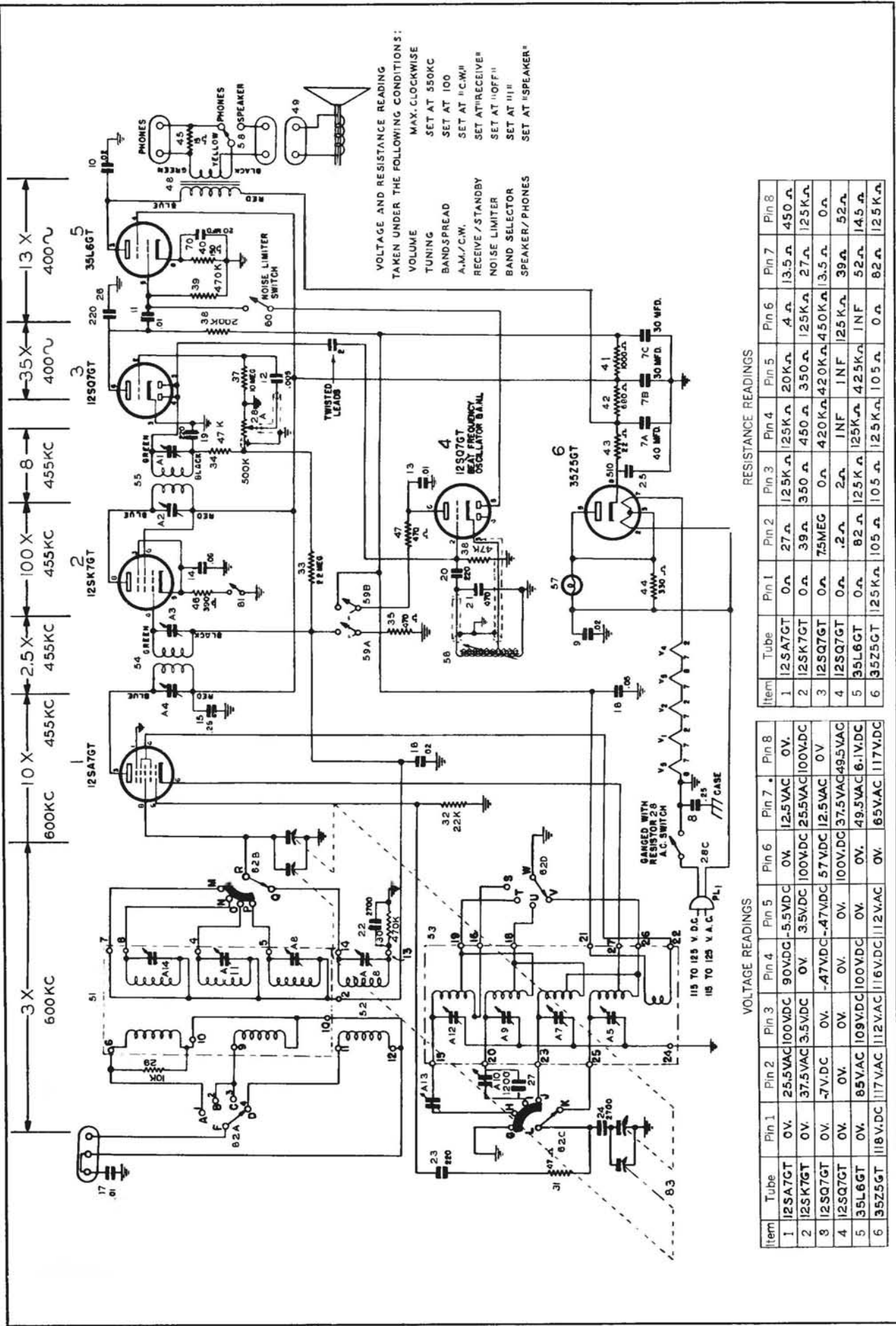

The stage gain measured values listed above are approximate values for an average operative stage, rather than an absolute value. It should be borne in mind that it is possible to introduce so many variables into the measurement operation, such as, type of equipment used for measuring, handling and placement of probes, the accuracy of alignment, etc., that an absolute reading is impractical. AVC is made inoperative and 3-volt battery bias substituted for measurement.

1. DC Voltage measurements are at 20,000 ohms per volt; AC Voltages measured at 1,000 ohms per volt.
2. Socket connections are shown as bottom views.
3. Measured values are from socket pin to common negative.
4. Line voltage maintained at 117 volts for voltage readings.
5. Nominal tolerance on component values makes possible a variation of $\pm 10\%$ in voltage and resistance readings.
6. Volume control at maximum, no signal applied for voltage measurements.

Hallicrafters, Inc.

Model: S-38

Chassis:

Year: Pre 1948

Power:

Circuit:

IF:

Tubes:

Bands:

Resources

[Riders Volume 17 - CHANGES 17-3](#)

[Riders Volume 15 - HALLICRAFTERS 15-59](#)

[Riders Volume 15 - HALLICRAFTERS 15-60](#)

[Riders Volume 15 - HALLICRAFTERS 15-61](#)

[Riders Volume 15 - HALLICRAFTERS 15-62](#)

[Riders Volume 15 - HALLICRAFTERS 15-63](#)

[Riders Volume 15 - HALLICRAFTERS 15-64](#)

Farnsworth Models

The parts shortage has resulted in the substitution of various types of tuning capacitors without change in part numbers stamped on them. In ordering replacement tuning capacitors for ET-060, 061, 063, 064, 065, 066, 069; EK-263, 264, and 265 the following suggestions should be observed:

Gang Capacitor with 21 plate oscillator section requires the removal of trimmer from r-f section of gang if the loop antenna has a r-f trimmer located on it. This capacitor used B.C. oscillator coil #38483 and, if an S.W. oscillator coil is used requires S.W. oscillator coil #38549. Both of these coils have a white dot to indicate finish lug.

A #26239 gang capacitor with 19 plate oscillator section (identified by red dot on rear) may require the removal of r-f trimmer as explained above. This capacitor requires B.C. oscillator coil #38706 and S.W. oscillator coil (if used) #38709. These oscillator coils are marked with a yellow dot at the finish lug.

The following is an alignment hint for the Farnsworth models with respect to the use of the antenna:

The antenna should be held in a vertical position, $\frac{3}{8}$ inch from the back side of the radio chassis in order to maintain the maximum output of the antenna after being installed in the cabinet. Therefore, we suggest some type of a jig to be made out of scrap material found around the service department to hold said antenna in the proper position while the serviceman is realigning the radio out of the cabinet. This suggestion is very helpful in getting the best operation out of the radio and, in addition, saving expense and time.

GALVIN DIAL CORD SLIPPAGE

Dial slippage encountered in 1946 home sets using slide rule type dials can easily be remedied by restringing using two dial cords.

Formerly, a single cord and tension spring was used for both driving the tuning capacitor and moving the pointer. It is recommended that two cords and tension springs be used; one for driving the tuning capacitor and one for moving the pointer.

Before removing the old cord, make a sketch showing the old cord layout. This will assist greatly in restringing.

First install the drive cord between the tuning shaft and tuning capacitor pulley. It is to be routed in exactly the same manner as the old cord was, except run it only between the tuning shaft and tuning capacitor pulley. Be sure to wind 3 turns around the tuning shaft. The old tension

spring is used to provide tension on the cord by hooking in exactly as before. Use the cord originally on the set for this purpose, except cut it down to the required length.

Install the pointer cord supplied by routing it in the same fashion as before except that it does not go to the tuning shaft. Simply run it to the tuning capacitor pulley and apply light tension to it with the attached tension coil spring. There are several holes in the tuning capacitor pulley through which the tension spring may be hooked and/or adjusted.

To calibrate pointer, simply turn the tuning capacitor to the fully meshed position and set pointer to "V" notch or calibration mark provided.

Use a drop of household cement to fix pointer to cord. A drop of cement on all knots will secure them.

Gamble-Skogmo 43-7601, 43-7601A, 43-7601B

These models, shown on pages 16-1 to 16-5 of *Rider's Volume XVI*, use the General Instrument Record Changer model 205, which can be found on pages RCD.CH. 15-5 to 15-8 of *Rider's Volume XV*.

General Electric 250

To reduce the hum in this model, which is found on pages 15-32 to 15-36 of *Rider's Volume XV*, it is suggested that the following change be made.

Resistor R16 (2200 ohms) should be removed from the negative battery terminal lug, lengthen pigtail, insulate with a spaghetti covering, and solder to the ground lug of the terminal board located at socket saddle of the 1LH4 tube.

An appreciable increase in duration of operation from a fully charged battery in this model can be effected in the following manner, realizing, however, that some degree of performance is sacrificed in regard to sensitivity and power output. Replace power-supply filter resistor, R17 (1500 ohms) with one of 4700 ohms, 1 watt, carbon. This change should be made only when the customer demands a longer duration of operation to one battery charge.

Hallcrafters S-38

In the event that an a-c hum develops in this receiver, the schematic of which appears on page 15-59 of *Rider's Volume XV*, it has been found that the 35Z5GT is the cause of the trouble, even though the tube passes a normal test. Also, other tubes in this set have been known to cause hum. Try replacement tubes.

Another cause is a high resistance ground between the chassis and the case.

This usually develops through the rubber mounting grommets or through the switch mounting rivets. Occasionally it may be a defective 25- μ f capacitor (C36), which should be replaced if defective. It is possible that C36 is not of the correct value. Check this point.

If this set loses sensitivity after being in use for approximately a half hour, replace the 12SA7GT/G tube, as an investigation has revealed that this condition is due to a certain percentage of Hytron tubes of this type, of a particular production run marked 1/6, 2/6, 1A6, or 2A6. The replacement should have any other marking than those listed previously.

Hallcrafters S-40

In the event that band 4 (15.7 to 43 mc) fails to operate at all times, but reception on other bands is normal, trouble is indicated in the oscillator circuit of this band, which in most cases can be traced to a weak 6SA7 oscillator tube or low line voltage. In those few cases where trouble persists, even though all voltages are normal and the tube has been replaced, this trouble can be remedied by replacement of the oscillator coil T9 and capacitor C18, as follows:

Replace T9 oscillator coil, part #51B791 containing 7 primary turns, with part #51B791B, having 10 primary turns. Change capacitor C8 (100 μ f) to part #CC25UK680K, 68 μ f. Connect the cathode lead from terminal 6 of the 6SA7 (V2) to T9 direct to the secondary winding where it leaves the coil form rather than to terminal lug "A" on the top of the coil form. (See sketch of coil form on page 15-67, 68 in *Rider's Volume XV*.) Replacement coils are furnished without the iron cores, as they are interchangeable. If new cores are needed, due to loss or breakage, they can be ordered under part #77A068.

If the receiver cannot be placed in "break-in" operation, apply the following remedy: Notice on the schematic of the receiver on page 15-67, 68 in *Rider's Volume XV* that the grid of V6 the output 6F6G tube is connected to the power switch S7, so that when the switch is in the "send" position the grid of this tube is grounded. Many operators wish to leave this switch in the "send" position and connect from terminal 5 on the plug PL2, through the transmitter relay to ground. In order to do this, the lead between S7 and V6 should be removed. On later production runs, this lead has been eliminated. See notes on "Power Requirements" and "Preparation for Use" on page 15-71 of *Rider's Volume XV*.

THE HALLCRAFTERS CO.

MODEL S-38, Early and Revised

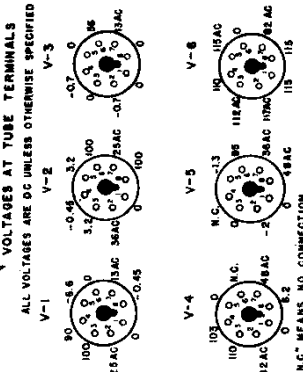
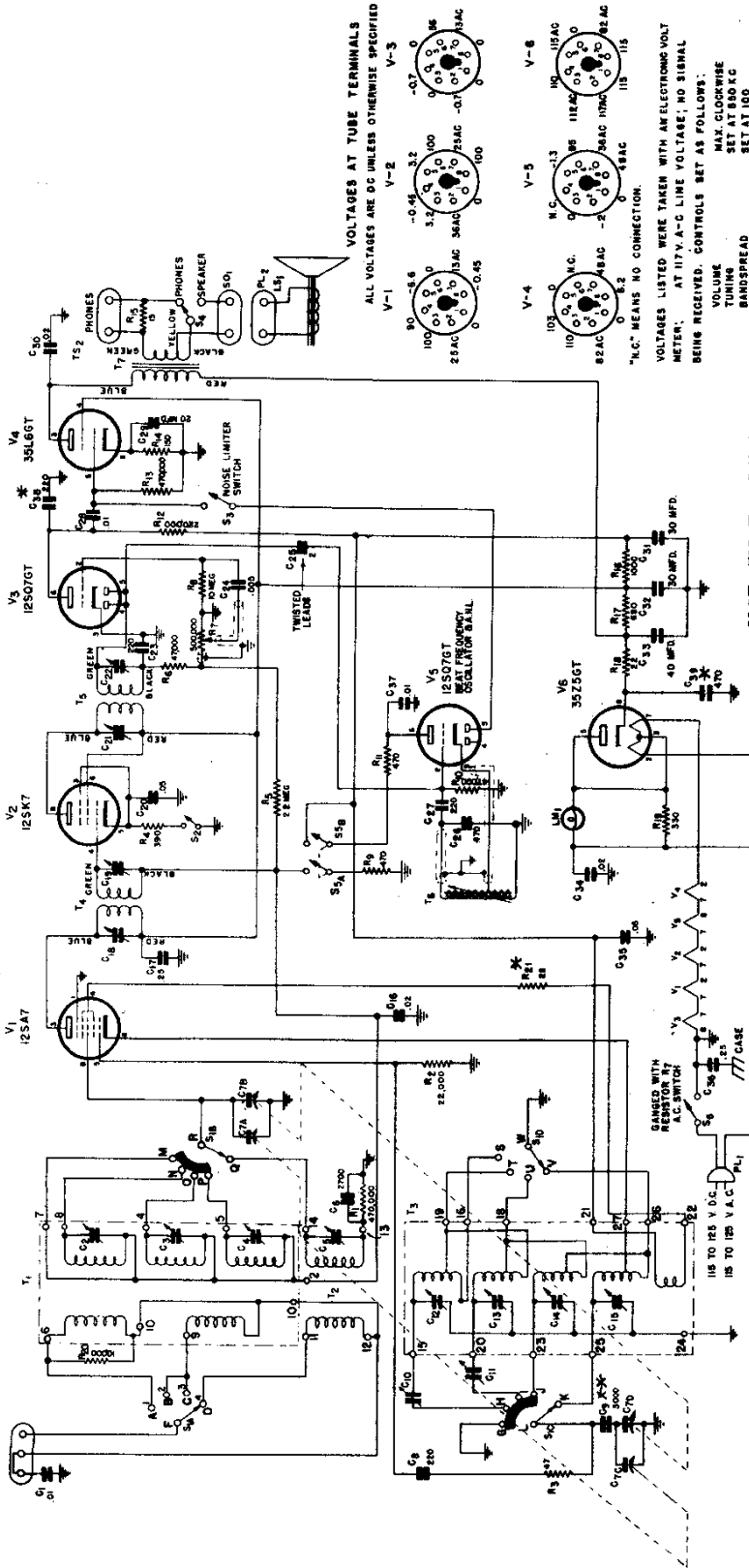

VOLTAGES AT TUBE TERMINALS
ALL VOLTAGES ARE DC UNLESS OTHERWISE SPECIFIED

"N.C." MEANS NO CONNECTION.
VOLTAGES LISTED WERE TAKEN WITH AN ELECTRONIC VOLT METER, AT 117 V. A-C LINE VOLTAGE; NO SIGNAL BEING RECEIVED. CONTROLS SET AS FOLLOWS.

- VOLUME MAX. CLOCKWISE
- BANDSPREAD SET AT 80 KC
- A.M./C.W. SET AT "CW"
- RECEIVE/STANDBY SET AT "RECEIVE"
- NOISE LIMITER SET AT "OFF"
- BAND SELECTOR SET AT "1"
- SPEAKER/PHONES SET AT "SPEAKER"

NOTE: RESISTANCE VALUES ARE IN OHMS; MICA CAPACITOR VALUES ARE IN DEKAL VALENTS OF .MFD; ELECTROLYTIC CAPACITOR VALUES ARE IN MFD.

IF PEAK 455 KC

*NOT IN EARLY MODELS

**C9 WAS 2700 μF IN EARLY MODELS

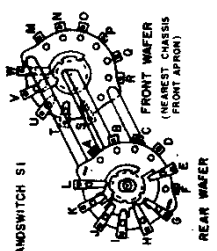
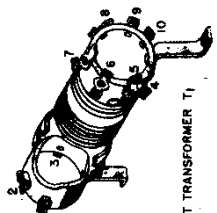
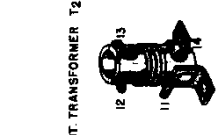
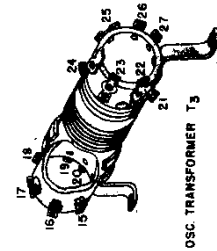

NOTE: DIMENSIONS & PROPORTIONS SHOWN IN PICTORIAL VIEWS HAVE BEEN EXAGGERATED FOR CLARITY OF TERMINAL LUG LOCATION.

GENERAL: Model S-38 is a 6 tube AC/DC superheterodyne table model, radio receiver, incorporating 4 bands of AM/CW reception, as follows: band #1, 540 kc to 1650 kc; band #2, 1650 kc to 5.0 mc; band #3, 5.0 mc to 14.5 mc; band #4, 13.5 mc to 32.0 mc.

August 1946

"clarified schematics"

MODEL S-38, Early
and Revised

THE HALLICRAFTERS CO.

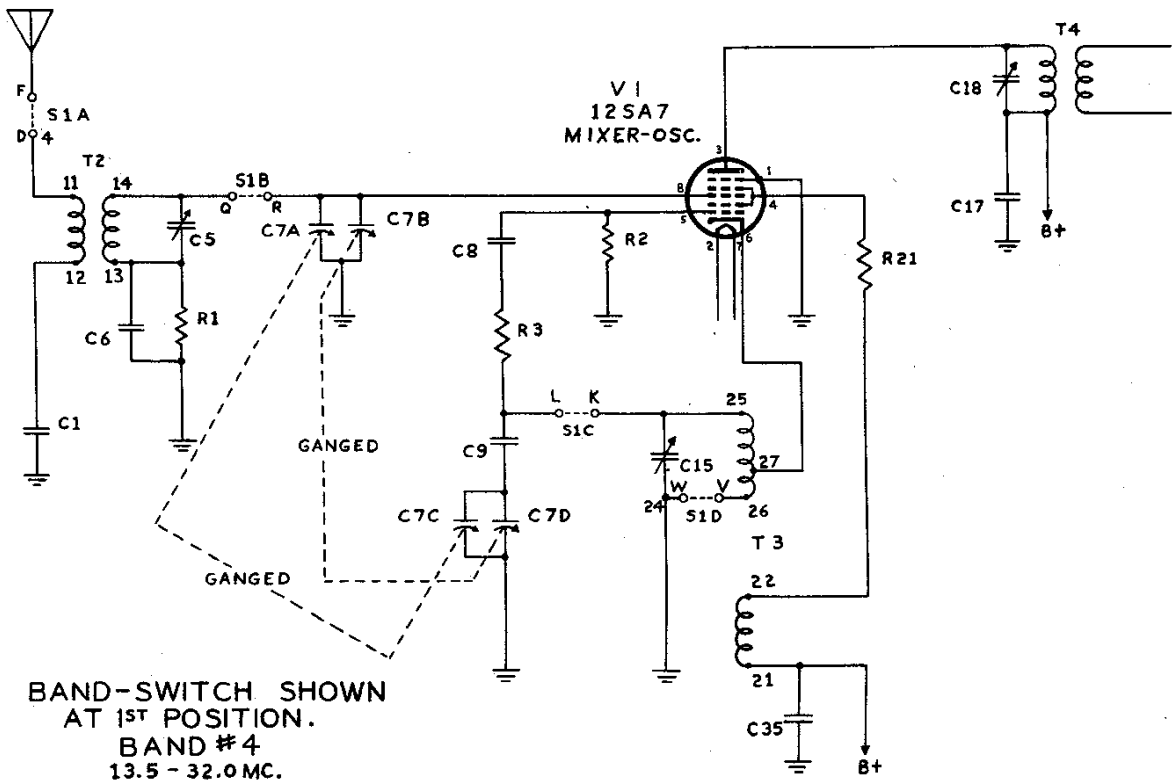

BAND-SWITCH SHOWN
AT 1ST POSITION.
BAND #4
13.5 - 32.0 MC.

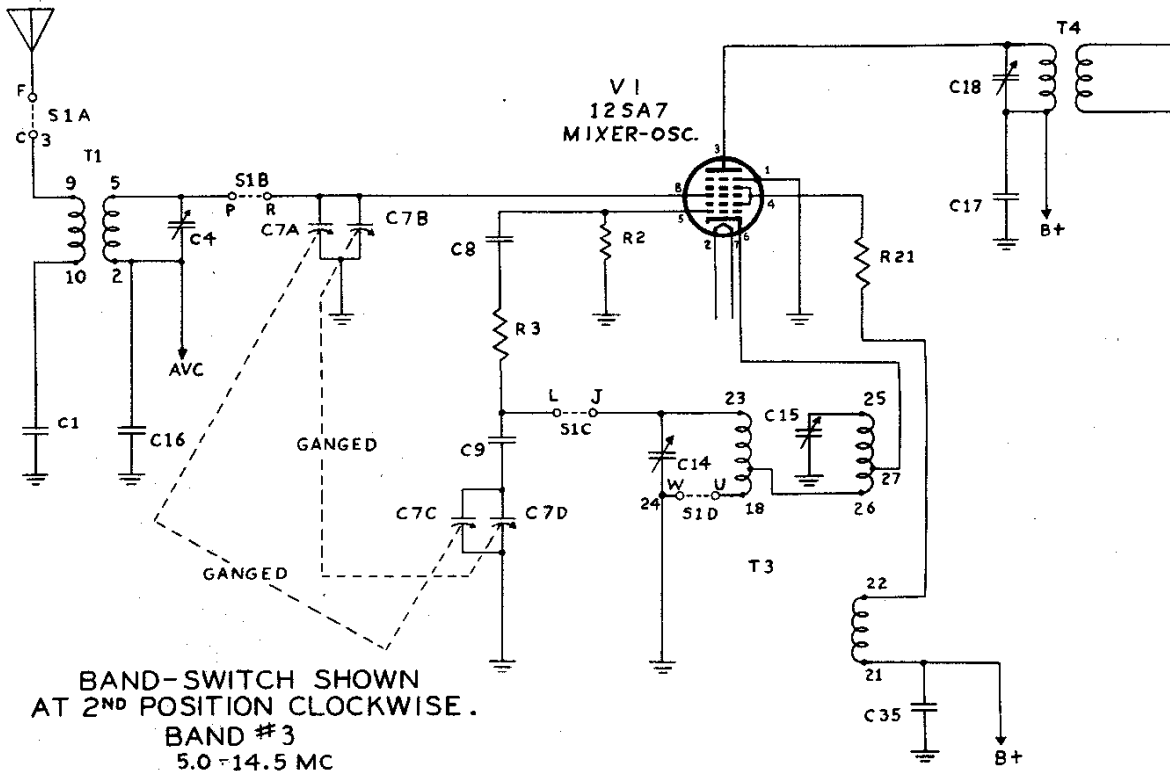

BAND-SWITCH SHOWN
AT 2ND POSITION CLOCKWISE.
BAND #3
5.0 - 14.5 MC

THE HALLICRAFTERS CO.

MODEL S-38, Early
and Revised

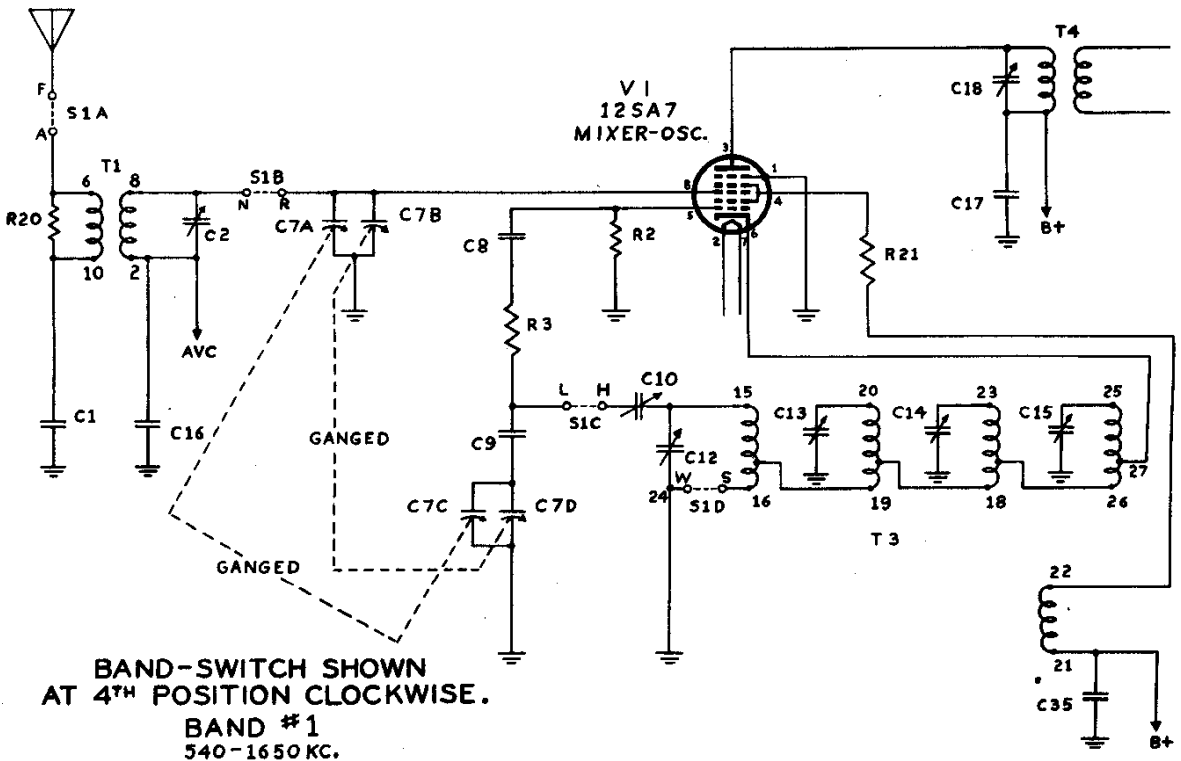
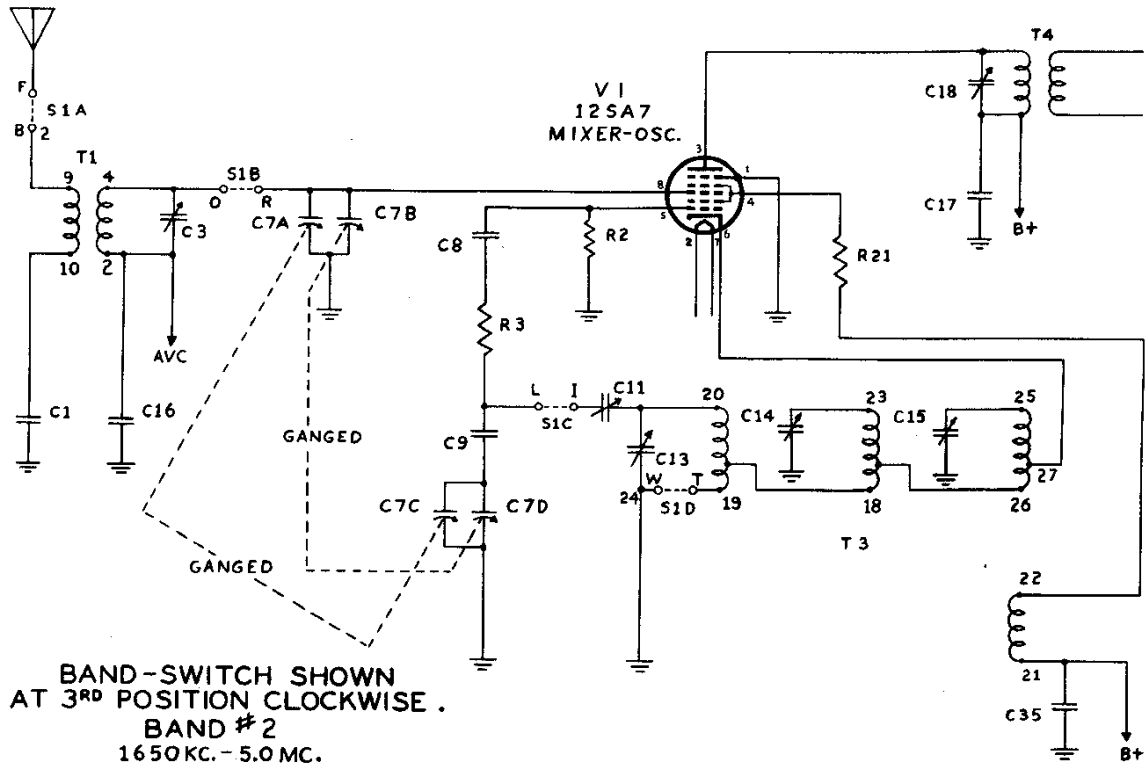

MODEL S-38, Early
and Revised

THE HALLICRAFTERS CO.

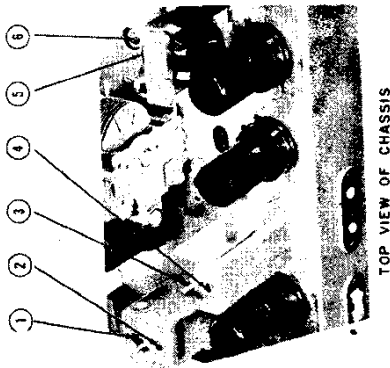

TOP VIEW OF CHASSIS

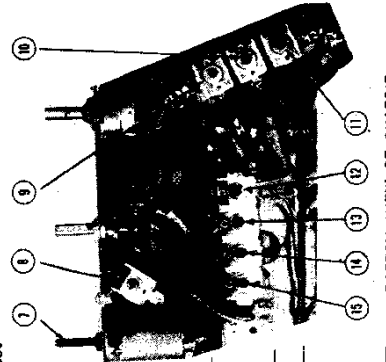

BOTTOM VIEW OF CHASSIS

Fig. 5. Top and bottom views of the receiver locating slugs, padders and trimmers for alignment purposes.

| IF FREQUENCY | IF SELECTIVITY | IMAGE RATIO | SENSITIVITY | AUDIO OUTPUT |
|--------------|---|---|---|---|
| 455 kc | 7 kc wide at 6 db down 65 kc wide at 60 db down (for 50 milliwatt output) | 2.7:1 at 30 mc 6:1 at 14 mc 10:1 at 5 mc 35:1 at 1500 kc | 12 microvolt at 600 kc 12 microvolt at 5 mc 11 microvolt at 14 mc 23 microvolt at 30 mc (for 50 milliwatt output) | 675 milliwatt with less than 10% distortion at 400 cycles |

EQUIPMENT:

- Signal Generator capable of the ranges indicated in the Alignment Chart, including a 400 cycle audio modulator.
 - Output meter capable of handling 1 watt of audio power.
 - Standard RMA dummy consisting of a 200 mmf condenser in series with a 20oh r-f choke which is shunted by a 400 mmf condenser in series with a 400 ohm carbon resistor.
 - Non-metallic screw driver.
- CONNECTIONS:** Connect the Sig. Gen. "cold" lead to "G" on the antenna strip; the "hot" lead is connected as indicated in the Chart.

Connect the output meter across the terminals of socket SO-1 and remove the speaker plug from the socket and adjust the meter for 3 ohms impedance.
Caution: Set the meter at a sufficiently high range to prevent possible damage from overload.
CONTROL SETTINGS: After allowing about a ten minute warm up period, set the receiver's control as follows:
SPEAKER/PHONES switch at "SPEAKER."
VOLUME control at full clockwise (maximum).
CW/AM switch at "AM" (except for BFO adjustment).
NOISE LIMITER switch at "OFF."
BANDSPREAD TUNING control at "0," (min. cap.).
STANDBY/RECEIVE switch at "RECEIVE."

| DUMMY ANT. IN SERIES WITH SIG. GENERATOR | CONNECTION OF SIGNAL GENERATOR OUTPUT TO RECEIVER | SIG. GEN. FREQUENCY SETTING | BAND SWITCH SETTING | RECEIVER ADJUST SLUG, DIAL PADDLE, OR TRIMMER NO. | DESCRIPTION | TYPE OF ADJUSTMENT -- MAKE ADJUSTMENT FOR: | STEP NO. |
|--|---|-----------------------------|---------------------|---|------------------------------|--|----------|
| None | Sator plates of rear sect. of tuning gang | 455 kc | "1" | 3 and 4 1 and 2 | 2nd IF 1st IF | Maximum output Maximum output Repeat steps 1 and 2 | 1 2 |
| None | Sator plates of rear sect. of tuning gang | 455 kc | "1" | 7 | BFO slug | Zero beat | 3 |
| BFO ADJUSTMENT — NOTE: Turn off Sig. Gen. 400 cycle modulation; set CW/AM switch at "CW"; remove Pitch Control knob and adjust slotted screw shaft. | | | | | | | |
| BAND #4 ADJUSTMENT — NOTE: Make sure 400 cycle audio modulator is turned on; AM/CW switch should be at "AM." | | | | | | | |
| STANDARD RMA Dummy strip | "A1" on antenna | 30 mc 30 mc | "4" | 12 † 8 | Osc. Trimmer Mix. Trimmer | Maximum output Maximum output | 4 5 |
| BAND #3 ADJUSTMENT | | | | | | | |
| STANDARD RMA Dummy strip | "A1" on antenna | 14 mc 14 mc | "3" | 13 † 9 | Osc. Trimmer Mix. Trimmer | Maximum output Maximum output | 6 7 |
| BAND #2 ADJUSTMENT | | | | | | | |
| STANDARD RMA Dummy strip | "A1" on antenna | 5 mc 1.8 mc | "2" | 14 6 | Osc. Trimmer Osc. Padder | Maximum output Maximum output and repeat step 8 | 8 9 |
| STANDARD RMA Dummy strip | "A1" on antenna | 5 mc | "1" | † 10 | Mix. Trimmer | Maximum output | 10 |
| BAND #1 ADJUSTMENT | | | | | | | |
| STANDARD RMA Dummy strip | "A1" on antenna | 1500 kc 600 kc | "1" | 15 5 | Osc. Trimmer Osc. Padder | Maximum output Maximum output and repeat step 11 | 11 12 |
| STANDARD RMA Dummy strip | "A1" on antenna | 1500 kc | "1" | 11 | Mix. Trimmer | Maximum output | 13 |

*It may be necessary to repeat the indicated adjustments several times.
†Rock the main tuning capacitor slightly (turn back and forth) when making these adjustments.

THE HALLICRAFTERS CO.

MODEL S-38, Early
and Revised

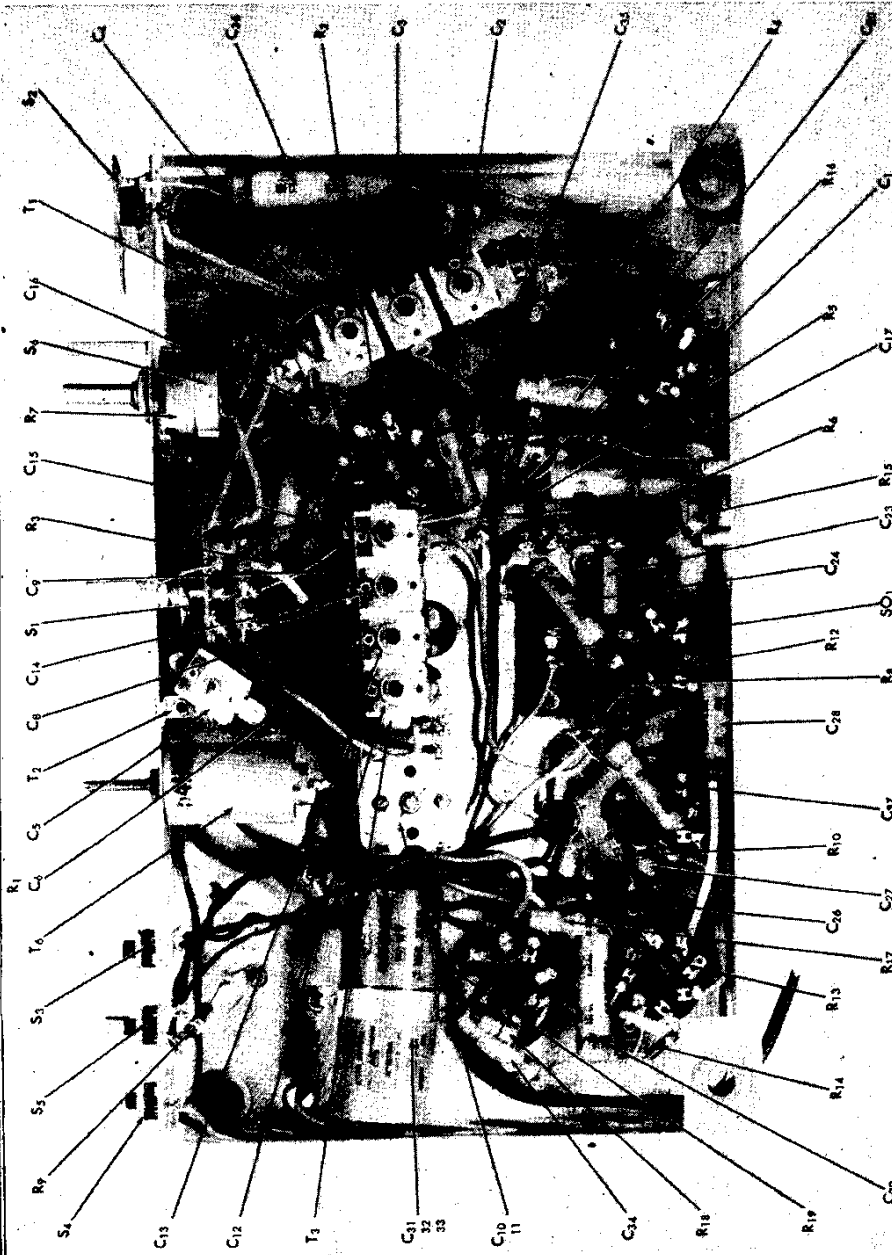

Fig. 4. Bottom view of the receiver showing component locations.

CONTROL SETTINGS FOR PRELIMINARY TEST OPERATION (Broadcast Band)

| NAME | FUNCTION | SETTING | NAME | FUNCTION | SETTING |
|---------------------|---|-----------------------------------|--------------------|--|---|
| STANDBY/ RECEIVE | Receiver temporary standby | At "RECEIVE" | SPEAKER/ PHONES | Output selector switch | At "SPEAKER" |
| VOLUME | Audio gain control and receiver on/off switch | Half clockwise; adj. as necessary | CW/AM | BFO on/off switch AVC on/off switch | At "AM" (AVC on) |
| BAND SELECTOR | Operating band selector | Clockwise to "1" | NOISE LIMITER | Noise peak limiting | At "OFF" |
| PITCH CONTROL | CW beat note pitch selector | Any position (not in use) | TUNING | Main tuning control | To local station freq. on main dial scale |
| | | | BAND SPREAD | Short wave band spreading | To "0" on small dial scale |

MODEL S-38, Early
and Revised

THE HALLICRAFTERS CO.

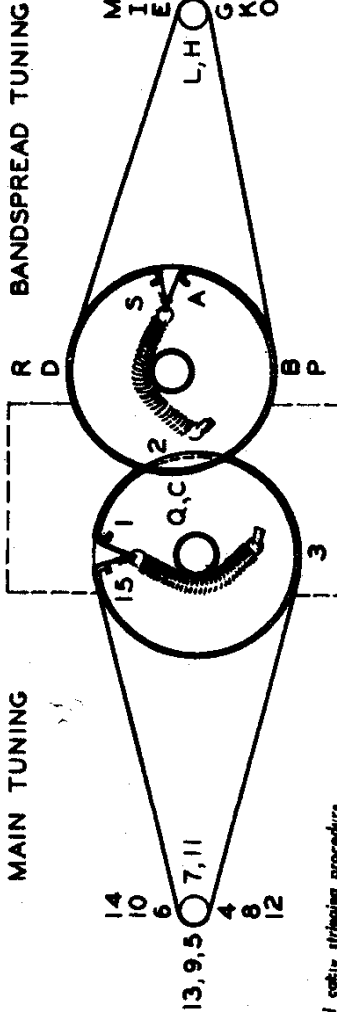

Fig. 2. Dial cable strapping procedure.

**TUNING CAPACITOR FULLY CLOSED (BOTH SECTIONS).
FRONT VIEW**

| REF. NO. | DESCRIPTION | HALLICRAFTERS PART NUMBER | LIST PRICE PER COMPONENT |
|-------------------|--|---------------------------|--------------------------|
| C-1 | 0.01 mfd; 600 vdw; mica. | 46AY103J | .10 |
| C-2, 3 & 4 | Trimmer Unit for antenna transformer T-1. | 44B129 | .10 |
| C-5 | Trimmer for antenna transformer T-2. | 44A039 | .10 |
| C-6 | 2700 mfd; ± 5%; 500 vdw; mica. | CM30A272J | .30 |
| C-7 | Tuning capacitor; air; 2 sections ganged. | 48C182 | 2.90 |
| C-8, 23, 27 & 38 | 250 mfmf; 500 vdw; mica. | CM20A221K | .15 |
| C-9 | 3000 mfmf; 5% 500 vdw; mica. | CM30A302J | .65 |
| C-10 & 11 | Dial padder for oscillator transformer T-3. | 44A152 | .50 |
| C-12, 13, 14 & 15 | Trimmer Unit for oscillator transformer T-3. | 44B159 | .10 |
| C-16 & 34 | 0.02 mfd; 400 vdw; paper. | 46AW203J | .10 |
| C-17 & 36 | 0.25 mfd; 200 vdw; paper. | 46AT254J | .25 |
| C-18, 19, 21 & 22 | Trimners for IF transformers T-4 and T-5. | 44A087 | .25 |
| C-20 & 35 | 0.05 mfd; 200 vdw; paper. | 46AU603J | .10 |
| C-24 | 0.005 mfd; 500 vdw; paper. | 46AW502J | .10 |
| C-25 & 39 | 2 mfmf; twisted insulated wire leads; NOT AVAILABLE AS A SPARE PART. | CM20A471K | .20 |
| C-28 & 37 | 470 mfd; 500 vdw; mica. | 46AW102J | .10 |
| C-29, 31, 32 & 35 | Electrolytic; four section unit; color coded leads; sect. 1 (C-29) 20 mfd, 25 vdw; sect. 2 (C-31) 40 mfd, 150 vdw; sect. 3 (C-32) 30 mfd, 150 vdw; sect. 4 (C-33) 40 mfd, 150 vdw. | 46B091 46Y203J | .80 .10 |
| C-30 | 0.02 mfd; 600 vdw; paper. | 46Y203J | .10 |
| LM-1 | 6/8 v @ 150ms; brown bead; G. E. type 47. | 39A004 | .10 |
| LS-1 | 5" P. M. speaker; 3.2 ohm voice coil. | 85C035 | 2.50 |
| PL-1 | AC line cord with two prong plug at one end. | 87A078 | .35 |
| PL-2 | Speaker voice coil connector plug. | 88A072 | .10 |
| R-1 & 13 | 470,000 ohm; 1/2 watt; carbon. | RC20AE474M | .10 |
| R-2 | 22,000 ohm; 1/2 watt; carbon. | RC20AE223M | .10 |
| R-3 | 390 ohm; 1/2 watt; carbon. | RC20AE391K | .10 |
| R-4 | 2.2 megohm; 1/2 watt; carbon. | RC20AE223M | .10 |
| R-5 | 47,000 ohm; 1/2 watt; carbon. | RC20AE473M | .10 |
| R-6 & 10 | Volume Control; 1/2 megohm; includes SPST toggle action switch assembly on rear. | 28B094 | .50 |
| R-7 & S-6 | 10 megohm; 1/2 watt; carbon. | RC20AE106M | .10 |
| R-8 | 470 ohm; ± 10%; 1/2 watt; carbon. | RC20AE471K | .10 |
| R-9 & 11 | 220,000 ohm; 1/2 watt; carbon. | RC20AE224M | .10 |
| R-12 | 150 ohm; ± 10%; 1/2 watt; carbon. | RC20AE151K | .10 |
| R-13 | 15 ohm; 1/2 watt; carbon. | RC20AE150M | .10 |
| R-14 | 800 ohm; 1/2 watt; carbon. | RC20AE801M | .10 |
| R-15 | 220,000 ohm; 1/2 watt; carbon. | RC20AE220M | .10 |
| R-16 | 330 ohm; 1/2 watt; carbon. | RC20AE331M | .10 |
| R-17 & 21 | 10,000 ohm; 1/2 watt; carbon. | RC20AE103M | .10 |

HOW TO RESTRING DIAL CORDS
To restring the main tuning dial cord, cut a 14" length of 30 lb. test dial cord and tie one end to the tension spring of the main tuning capacitor drive pulley at position "1" on the diagram. Following the numbers 1 through 15, wind the cord on the pulley and knob drive shaft. At position "15", stretch the tension spring and tie the cord securely. Cut off the excess cord. Note that two complete turns are wound on the knob drive shaft.

To restring the band-spread tuning dial cord, cut a 16" length of dial cord and follow the procedure as explained above, except start at position "A" on the diagram and proceed through position "S". Note that the knob drive shaft has two complete turns.

| REF. NO. | DESCRIPTION | HALLICRAFTERS PART NUMBER | LIST PRICE PER COMPONENT |
|----------------|--|---------------------------|--------------------------|
| S-1a, b, c & d | Bandswitch; two sections ganged; rotary four position. | 60A240 | \$.95 |
| S-2 & 3 | "RECEIVE-STANDBY" and "NOISE LIMITER" switches; slide action; SPST. | 60A244 | .20 |
| S-4 | "MAKER-PHONES" switch; slide action; SPST. | 60A243 | .20 |
| S-5 | "A.M.-C.W." switch; slide action; DPST. | 60A245 | .20 |
| T-1 | Antenna coil for bands 1, 2 and 3. | 51C821 | 2.35 |
| T-2 | Antenna coil for band 4. | 51C818 | 2.45 |
| T-3 | Output IF transformer; 455 kc. | 50C222 | 1.20 |
| T-4 | Diode IF transformer; 455 kc. | 50B184 | 1.20 |
| T-5 | Beat frequency oscillator coil; 455 kc. | 54B031 | 1.25 |
| T-6 | Audio output transformer; 3,000 ohm primary — 15 ohm secondary (tapped at 3 ohms). | 55A075 | .95 |
| T-7 | Antenna and ground connector strip. | 88A032 | .10 |
| TS-1 | Headset plug connector strip; bakelite. | 88A071 | .10 |

| REF. NO. | DESCRIPTION | HALLICRAFTERS PART NUMBER | LIST PRICE PER COMPONENT |
|----------|---|---------------------------|--------------------------|
| 2 | Knob; for Volume Control and Band Selector switches. | 15A049 | .15 |
| 1 | Knob; for C. W. PITCH Control. | 15A058 | .15 |
| 2 | Knob; for TUNING and BANDSPREAD Tuning Controls. | 15A047 | .25 |
| 1 | Pointer; for main tuning dial. | 82A102 | .15 |
| 1 | Calibrated dial assembly, complete. | 82A103 | .15 |
| 1 | Dial window; glass. | 22B157 | .30 |
| 6 | Octal tube sockets; Amphenol type MIP-8. | 6A035 | .10 |
| 1 | Dial lamp socket; bayonet. | 86A011 | .15 |
| 2 | Tuning capacitor dial drive pulley. | 28A002 | .10 |
| 1 | Tuning capacitor rear mounting bracket. | 67A358 | .10 |
| 1 | Left hand switch mounting bracket. | 67B559 | .10 |
| 4 | Right hand switch mounting bracket. | 67B561 | .10 |
| 2 | Supra-winding test for cabinet. | 16A007 | .10 |
| 1 | Spring washers for grounding tuning capacitor drive shafts. | 4A043 | .10 |
| 4 | "C" washers (hair-pin type). | 75A062 | .10 |
| 1 | Rear cover plate; cardboard. | 32C331 | .10 |
| 1 | Bottom cover plate; painted steel. | 63C220 | .45 |

NOTE: ALL PRICES ARE SUBJECT TO CHANGE WITHOUT NOTICE.