

HEATHKIT[®] MANUAL

for the

COLOR GENERATOR

Model IG-5240

595-1875-2

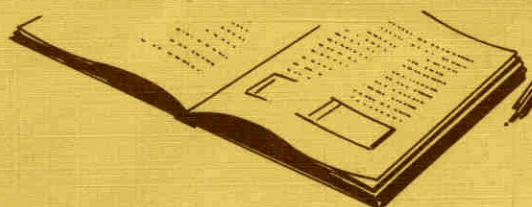

HEATH COMPANY • BENTON HARBOR, MICHIGAN

HEATH COMPANY PHONE DIRECTORY

The following telephone numbers are direct lines to the departments listed:

Kit orders and delivery information	(616) 982-3411
Credit	(616) 982-3561
Replacement Parts	(616) 982-3571

Technical Assistance Phone Numbers

8:00 A.M. to 4:30 P.M., EST, Weekdays Only

Audio	(616) 982-3310
Amateur Radio	(616) 982-3296
Test Equipment, Weather Instruments and Home Clocks	(616) 982-3315
Television	(616) 982-3307
Aircraft, Marine, Security, Scanners, Automotive, Appliances and General Products	(616) 982-3496
Computers — Hardware	(616) 982-3309
Computers — Software:	
Operating Systems, Languages, Utilities	(616) 982-3860
Application Programs	(616) 982-3884

YOUR HEATHKIT 90-DAY LIMITED WARRANTY

Consumer Protection Plan for Heathkit Consumer Products

Welcome to the Heath family. We believe you will enjoy assembling your kit and will be pleased with its performance. Please read this Consumer Protection Plan carefully. It is a LIMITED WARRANTY as defined in the U.S. Consumer Product Warranty and Federal Trade Commission Improvement Act. This warranty gives you specific legal rights, and you may also have other rights which vary from state to state.

Heath's Responsibility

PARTS — Replacements for factory defective parts will be supplied free for 90 days from date of purchase. Replacement parts are warranted for the remaining portion of the original warranty period. You can obtain warranty parts direct from Heath Company by writing or telephoning us at (616) 982-3571. And we will pay shipping charges to get those parts to you anywhere in the world.

SERVICE LABOR — For a period of 90 days from the date of purchase, any malfunction caused by defective parts or error in design will be corrected at no charge to you. You must deliver the unit at your expense to the Heath factory, any Heathkit Electronic Center (units of Veritechnology Electronics Corporation), or any of our authorized overseas distributors.

TECHNICAL CONSULTATION — You will receive free consultation on any problem you might encounter in the assembly or use of your Heathkit product. Just drop us a line or give us a call. Sorry, we cannot accept collect calls.

NOT COVERED — The correction of assembly errors, adjustments, calibration, and damage due to misuse, abuse, or negligence are not covered by the warranty. Use of corrosive solder and/or the unauthorized modification of the product or of any furnished component will void this warranty in its entirety. This warranty does not include reimbursement for inconvenience, loss of use, customer assembly, set-up time, or unauthorized service.

This warranty covers only Heath products and is not extended to other equipment or components that a customer uses in conjunction with our products.

SUCH REPAIR AND REPLACEMENT SHALL BE THE SOLE REMEDY OF THE CUSTOMER AND THERE SHALL BE NO LIABILITY ON THE PART OF HEATH FOR ANY SPECIAL, INDIRECT, INCIDENTAL OR CONSEQUENTIAL DAMAGES, INCLUDING BUT NOT LIMITED TO ANY LOSS OF BUSINESS OR PROFITS, WHETHER OR NOT FORSEEABLE.

Some states do not allow the exclusion or limitation of incidental or consequential damages, so the above limitation or exclusion may not apply to you.

Owner's Responsibility

EFFECTIVE WARRANTY DATE — Warranty begins on the date of first consumer purchase. You must supply a copy of your proof of purchase when you request warranty service or parts.

ASSEMBLY — Before seeking warranty service, you should complete the assembly by carefully following the manual instructions. Heathkit service agencies cannot complete assembly and adjustments that are customer's responsibility.

ACCESSORY EQUIPMENT — Performance malfunctions involving other non-Heath accessory equipment, (antennas, audio components, computer peripherals and software, etc.) are not covered by this warranty and are the owner's responsibility.

SHIPPING UNITS — Follow the packing instructions published in the assembly manuals. Damage due to inadequate packing cannot be repaired under warranty.

If you are not satisfied with our service (warranty or otherwise) or our products, write directly to our Director of Customer Service, Heath Company, Benton Harbor MI 49022. He will make certain your problems receive immediate, personal attention.

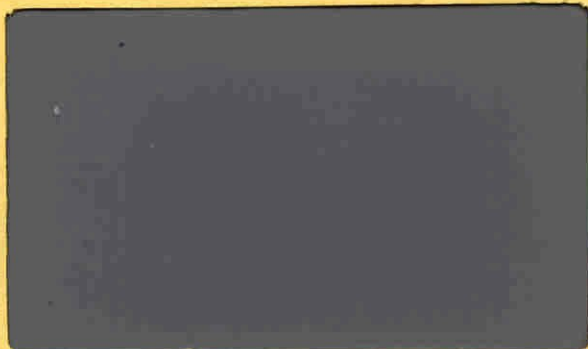

Heathkit® Manual

for the

COLOR GENERATOR

Model IG-5240

595-1875-2

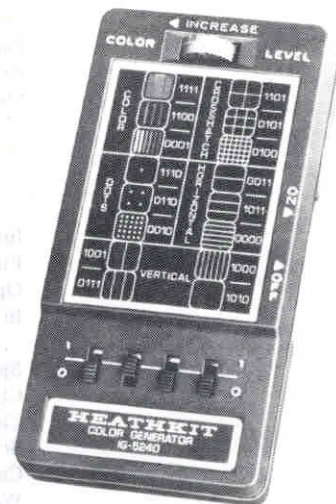

HEATH COMPANY
BENTON HARBOR, MICHIGAN 49022

Copyright © 1976
Heath Company
All Rights Reserved
Printed in the United States of America

TABLE OF CONTENTS

Parts List	3
Assembly Notes	10
Step-by-Step Assembly	
Video Circuit Board Assembly	13
RF Oscillator Circuit Board Assembly	21
Final Wiring	29
Housing Assembly	36
Initial Tests and Adjustments	38
Final Assembly	41
Operation	43
In Case of Difficulty	45
Troubleshooting Chart	46
Specifications	49
Circuit Description	51
Circuit Board X-Ray Views	52
Schematic	54
Component Identification Charts	56
Warranty	Inside front cover
Customer Service	Inside rear cover

PARTS LIST

Check each part against the following list. Any part packed in an individual envelope with a part number on it should be placed back in the envelope after you identify it until it is called for in a step. Do not throw away any packing material until all the parts are accounted for. The key numbers in the Parts List correspond to the numbers on the parts illustrations.

To order a replacement part, use the Parts Order Form furnished with this kit. If a Parts Order Form is not available, refer to "Replacement Parts" inside the rear cover of the Manual. For pricing information, refer to the separate "Heath Parts Price List."

Each circuit part in this kit has its own component number (R2, C4, etc.). Use these numbers when you want to positively identify the same part in the various sections of the Manual. These numbers, which are especially useful if a part has to be replaced, appear:

- In the Parts List.
- At the beginning of each step where a component is installed.
- In some illustrations.
- In the Schematic.

— In the sections that follow the Assembly section.

BATTERY

You should purchase the following batteries at this time for use in your kit:

Two 9-volt transistor batteries, NEDA #1604.

Representative manufacturers and their type numbers are:

Eveready #216, P3
Burgess #2V6
Mallory #TR-146X (long life)
RCA #VS323
Hellekens #410
Varta #438
CEI #6F22
Ray-O-Vac #D1604-1 (Long Life)

CHANNEL 3 OPERATION

If you are located near a Channel 4 television transmitter, you may want to operate your Color Generator on a different frequency to avoid channel 4 interference. Refer to "Alternate Channel Operation" on Page 44 of this Manual for information on ordering the correct channel selection crystal.

KEY No.	HEATH Part No.	QTY.	DESCRIPTION	CIRCUIT Comp. No.
---------	----------------	------	-------------	-------------------

RESISTORS

NOTE: The resistors may be packed in more than one envelope. Open all the resistor envelopes in this pack before you check them against the Parts List.

1/4-Watt 10%

A1	1-20-12	1	33 Ω (orange-orange-black)	R11
A1	1-37-12	3	150 Ω (brown-green-brown)	R8, R10, R12
A1	1-17-12	1	220 Ω (red-red-brown)	R14
A1	1-35-12	1	470 Ω (yellow-violet-brown)	R7
A1	1-2-12	1	1000 Ω (brown-black-red)	R103
A1	1-7-12	2	3900 Ω (orange-white-red)	R19, R20
A1	1-4-12	1	2200 Ω (red-red-red)	R9
A1	1-8-12	1	4700 Ω (yellow-violet-red)	R5
A1	1-28-12	1	8200 Ω (gray-red-red)	R104
A1	1-10-12	1	15 k Ω (brown-green-orange)	R2

KEY No.	HEATH Part No.	QTY.	DESCRIPTION	CIRCUIT Comp. No.
---------	----------------	------	-------------	-------------------

Resistors (cont'd.)

A1	1-45-12	1	22 k Ω (red-red-orange)	R16
A1	1-41-12	2	33 k Ω (orange-orange-orange)	R1, R101
A1	1-11-12	1	47 k Ω (yellow-violet-orange)	R13
A1	1-12-12	1	82 k Ω (gray-red-orange)	R15
A1	1-32-12	1	100 k Ω (brown-black-yellow)	R6

1/4-Watt 5%

A1	1-50-12	3	11 M Ω (brown-brown-blue)	R3, R4, R102
----	---------	---	----------------------------------	--------------

A1



KEY No.	HEATH Part No.	QTY.	DESCRIPTION	CIRCUIT Comp. No.
---------	----------------	------	-------------	-------------------

CONTROLS

A2	10-1074	1	1000 Ω (1k) control	R18
A3	10-1075	1	3000 Ω (3k) control	R17

CAPACITORS-INDUCTOR-CHOKE

B1	21-33	1	3.3 pF ceramic	C13
B1	21-3	1	10 pF ceramic	C102
B1	21-111	1	15 pF ceramic	C4
B1	21-51	1	20 pF ceramic	C7
B1	21-147	3	47 pF ceramic	C5, C103, C104
B1	21-17	1	270 pF ceramic	C3
B1	21-23	2	420 pF ceramic	C10, C11
B1	21-176	2	0.01 μ F ceramic	C6, C12

NOTE: Tantalum and Mylar* capacitors can be marked four different ways.
EXAMPLE: 10, 10k, 10m, 10 μ F. However, the parts list and installation instructions will always use μ F.

B2	25-220	3	10 μ F tantalum	C2, C8, C101
B2	25-289	1	47 μ F tantalum	C1
B3	27-74	1	0.01 μ F Mylar	C105
B4	31-65	1	15-60 pF ceramic trimmer	C9
B5	40-1773	1	72 MHz output inductor	L2
B6	45-57	1	10 μ H RF choke	L1

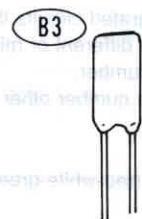
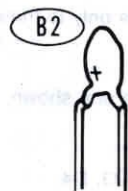
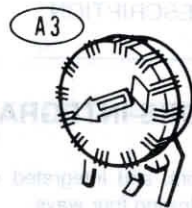

KEY No.	HEATH Part No.	QTY.	DESCRIPTION	CIRCUIT Comp. No.
---------	----------------	------	-------------	-------------------

DIODES-TRANSISTORS-INTEGRATED CIRCUIT

NOTE: The diodes, transistors, and integrated circuit can be marked for identification in one of the following four ways:

1. Part number.
2. Type number. (On integrated circuits this refers only to the numbers; the letters may be different or missing.)
3. Part number and type number.
4. Part number with a type number other than the one shown.

C1	56-20	4	1N295 (red-white-green) diode	D3, D4, D5, D6
C1	56-56	1	1N4149 diode	D1
C1	56-87	1	FH1100 diode	D2
C2	417-167	1	Selected JFET transistor	Q1
C3	417-806	1	TIS75 JFET transistor	Q3
C3	417-235	2	2N4121 transistor	Q2, Q4
C3	417-801	1	MPSA20 transistor	Q5
C4	442-624	1	5322 color generator integrated circuit. Do not remove it from its conductive foam pad.	IC101

C1

NOTE: HEATH PART NUMBERS ARE STAMPED ON MOST DIODES.

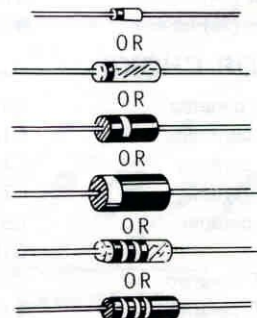

C2



C3

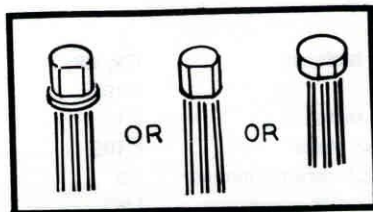

C4

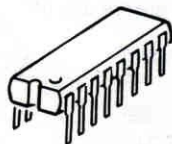

KEY No.	HEATH Part No.	QTY.	DESCRIPTION	CIRCUIT Comp. No.
---------	----------------	------	-------------	-------------------

CRYSTALS

D1	404-341	1	67.25 MHz	Y1
D1	404-577	1	377.616 kHz	Y101
D1	404-578	1	3563.795 kHz (3.563795 MHz)	Y2

WIRE-SLEEVE

89-43	9"	2-wire cable
340-3	12"	16-gauge bare wire
344-91	12"	Brown wire
344-92	4"	Red wire
344-93	12"	Orange wire
344-96	9"	Blue wire
344-97	9"	Violet wire
344-98	9"	Gray wire
344-99	3"	White wire
346-2	5"	Clear sleeve
346-20	3"	Black heat-shrink sleeve

KEY No.	HEATH Part No.	QTY.	DESCRIPTION	CIRCUIT Comp. No.
---------	----------------	------	-------------	-------------------

HARDWARE

E1	250-34	4	4-40 × 1/2" screw
E2	250-212	4	#2 × 3/16" screw
E3	259-22	2	Wire terminal lug

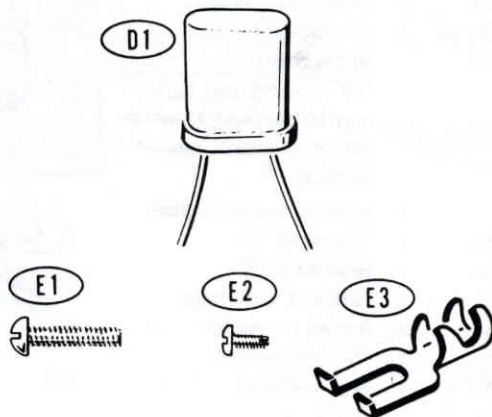

KEY No.	HEATH Part No.	QTY.	DESCRIPTION
---------	----------------	------	-------------

GENERAL PARTS

F1	60-614	4	Slide switch
F2	64-801	2	Pushbutton switch
F3	73-64	2	Foam pad
	85-1789-1	1	Video circuit board
	85-1790-1 or 85-1924-1	1	RF oscillator circuit board
			NOTE: Either part number may be supplied. However, the circuit boards are identical.
F4	95-618	1	Housing top and bottom
F5	390-1283	1	Trim label
F6	390-1284	1	Heathkit label
F7	391-34	1	Blue and white label
F8	432-798	2	Battery connector
F9	434-299	1	16-pin IC socket
F10	490-109	1	Alignment tool

CIRCUIT Comp. No.

SW101, SW102, SW103, SW104
SW201, SW202

KEY No.	HEATH Part No.	QTY.	DESCRIPTION
---------	----------------	------	-------------

597-260		1	Parts Order Form
		1	Assembly Manual (See front cover for the part number.)
			Solder

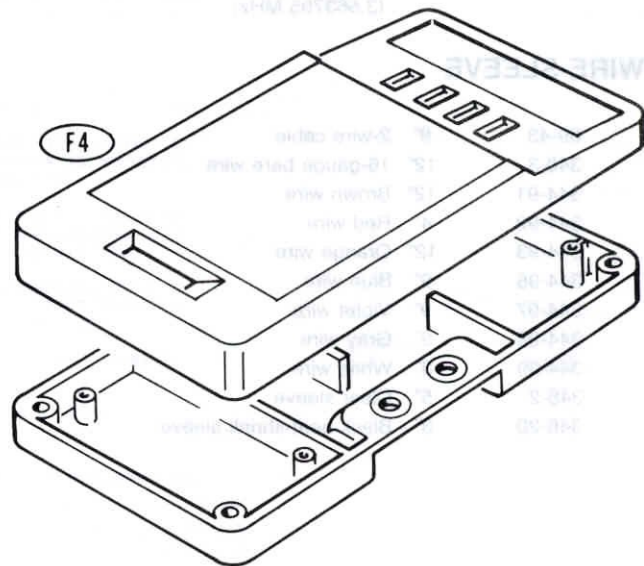
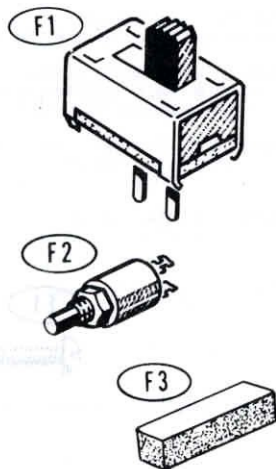

F5

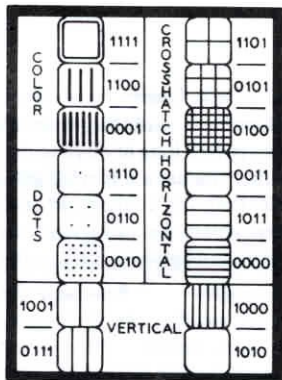

F8

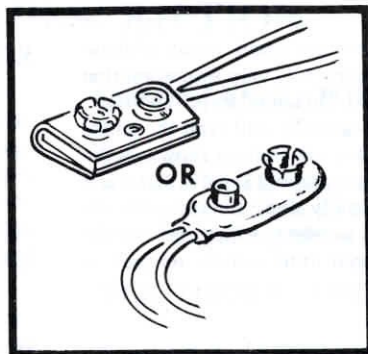

F10



F9

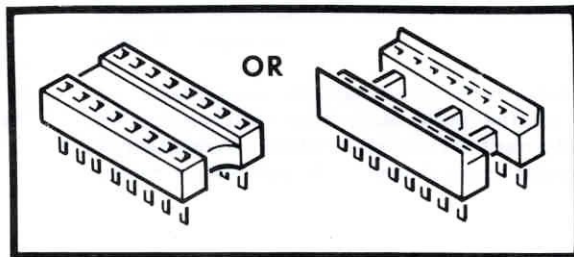

F6

HEATHKIT
 COLOR GENERATOR
 IG-5240

F7

HEATH
 MODEL SERIES NO.

ASSEMBLY NOTES

The circuit boards and their components are quite small. Many of these components break easily; handle them with care. It is very important that you take your time while you assemble this kit. Do not attempt "shortcut" procedures. Follow the Manual instructions carefully and read the **entire** step before you perform the operation. Position all parts as shown in the illustrations. These illustrations are called Pictorials and Details. Pictorials show the overall operation for a group of assembly steps; Details generally illustrate a single step. When you are directed to refer to a Pictorial "for the following steps," continue to use that Pictorial until you are referred to another Pictorial for another group of steps.

SOLDERING

When you solder, use a small-wattage soldering iron, allow it to reach operating temperature, and then apply it long enough to make a good solder connection. It is recommended that you use a soldering iron rated at 15 to 25 watts. The tip should be no wider than 1/8"; a pyramid or chisel-shaped tip is best. This type of soldering iron will make the kit easier to assemble, with less chance of solder bridges occurring between foils on the circuit board.

NOTE: If a small wattage, small-tip soldering iron is not available, proceed as follows: Be sure your soldering iron is cool. Then wrap the 16 gauge bare wire, supplied with this kit, tightly around the soldering tip as shown in Figure 1. Allow approximately 1/8" of wire to extend beyond the soldering iron tip. For good heat transfer, perform the following three steps.

1. Tighten the wire around the neck with a pair of pliers.
2. Melt some solder between the wire and the iron tip.
3. When you solder, keep the wire between the iron and the circuit board so that the wire is pressed against the iron tip.

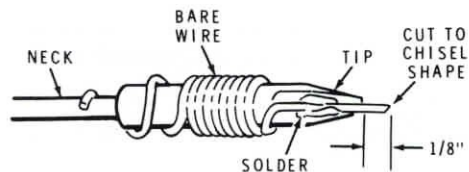

Figure 1

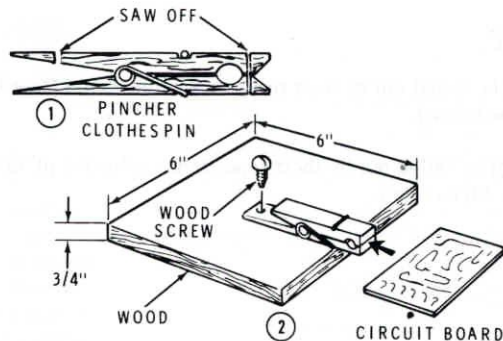

Figure 2

Because the circuit boards are small and tend to move when being soldered, it is a good idea to hold them in some manner. A simple jig made up of a small board and a pincher clothespin, as shown in Figure 2, works very well for this purpose. A small vise can also be used.

ASSEMBLY

Resistors will be called out by their resistance value in Ω , $k\Omega$, or $M\Omega$, and color code (see below).

Capacitors will be called out by their capacitance value (in pF or μF) and type (ceramic, Mylar, etc.).

When you are instructed to cut something to a particular length, use the scales provided at the bottom of the Manual pages.

NOTE: Because of the parts density on the two circuit boards, the component part numbers are not shown. Therefore, you must be careful to install the components in their correct location.

VIDEO CIRCUIT BOARD

START 

IMPORTANT: The following steps give detailed instructions on how to install and solder the first part on the circuit board. The remaining parts will be installed in a similar manner.

- () Position the video circuit board (#85-1789-1) as shown with the foil side down.
- () Hold a 33 k Ω (orange-orange) resistor and bend one lead sharply over as shown.

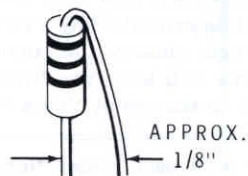

STEP-BY-STEP ASSEMBLY

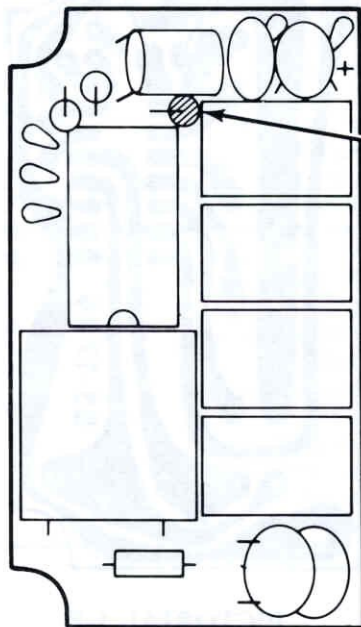

PICTORIAL 1-1

CONTINUE 

- () R101: Mount the 33 k Ω resistor vertically on the circuit board as shown. Bend both leads outward to hold the resistor in place. Be sure to use the correct holes.

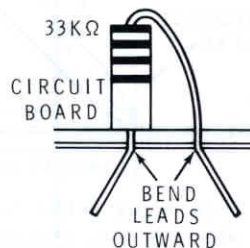

NOTE: Many of the components are not mounted in a vertical position.

START ↩

() Turn the circuit board over and solder the resistor leads to the circuit board as follows:

1. Push the soldering iron tip against both the lead and the circuit board foil. Heat **both** for 2 or 3 seconds.

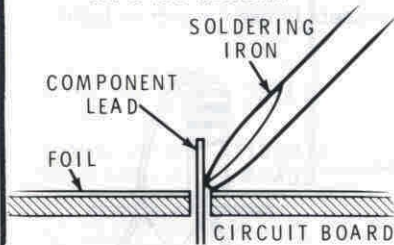

2. Then apply solder to the other side of the connection. **IMPORTANT:** Let the heated lead and the circuit board foil melt the solder.

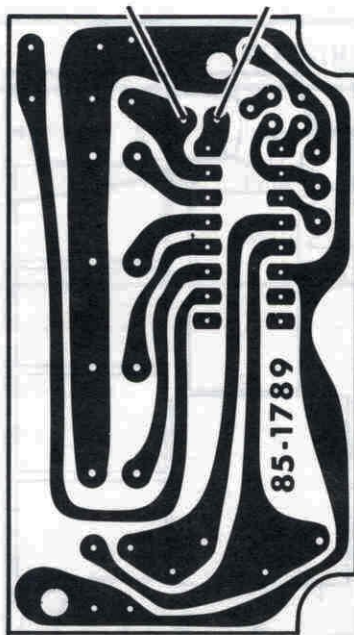
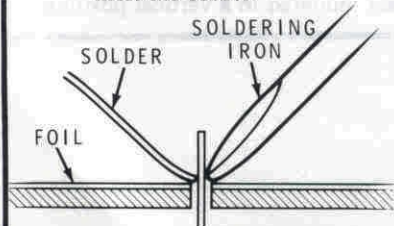

PICTORIAL 1-2

CONTINUE ↩

3. As the solder begins to melt, allow it to flow around the connection. Then remove the solder and iron and let the connection cool.

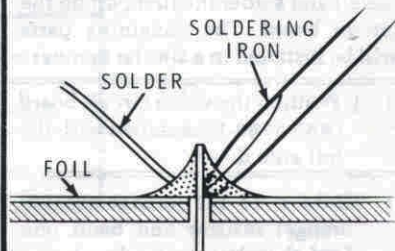

- () Hold each lead with one hand while you cut off the excess lead length close to the connection. This will keep you from being hit in the eye by flying lead.

- () Check each connection. Compare it to the illustrations on the next two pages. After you have checked the solder connections, proceed with the assembly on Page 17. Use the same soldering procedure for each connection.

Study the accompanying figures as you read the following paragraphs.

A GOOD SOLDER CONNECTION

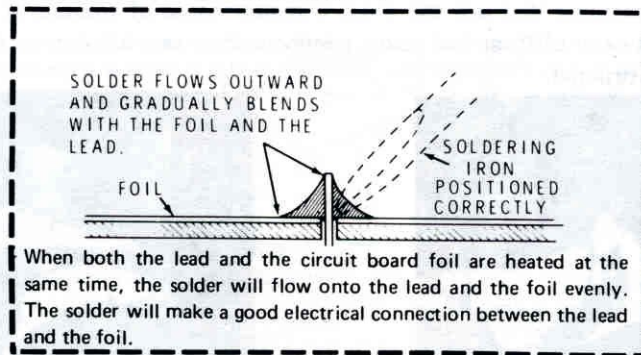

POOR SOLDER CONNECTIONS

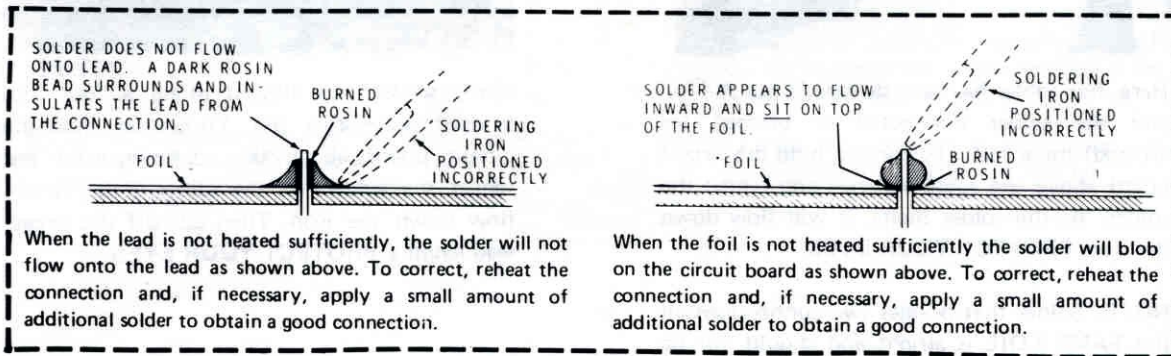

SOLDER CONNECTIONS TO WATCH OUT FOR

The following photographs show examples of the types of bad solder connections that are the most common cause of trouble. If you locate any of these bad solder connections in your kit, correct them as instructed.

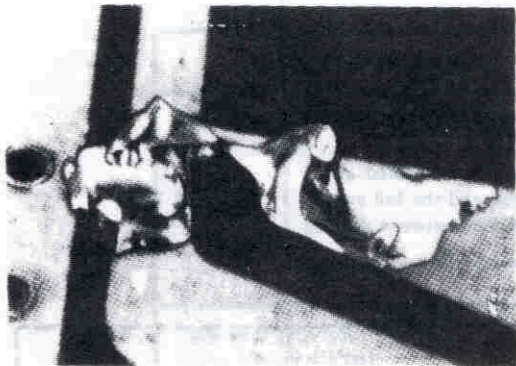

Here, hot solder has been dropped onto the foil and the solder connected or bridged (or crossed) three foils. To correct, hold the circuit board above the soldering iron and reheat the solder. As the solder melts, it will flow down the iron. **PROTECT YOUR EYES.**

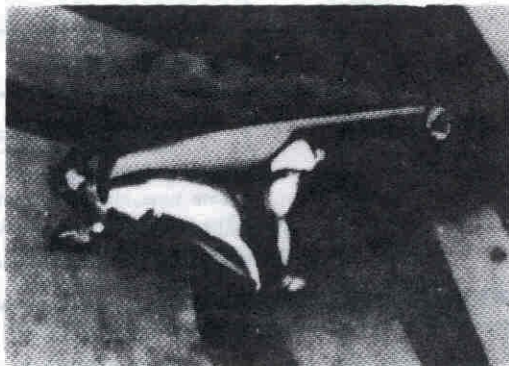

Here, solder has flowed along a lead and bridged to another foil. To correct, hold the circuit board above the soldering iron and reheat the solder. As the solder melts, it will flow down the iron. Then cut off the excess lead lengths. **PROTECT YOUR EYES.**

NOTE: Solder that bridges two connections on the SAME FOIL is alright and should not be corrected.

START 

() Position the circuit board as shown with the foil side down.

() 16-pin integrated circuit socket. Insert the socket pins into the holes. The index mark on the circuit board should still be visible after it is installed. Solder the pins to the foil.

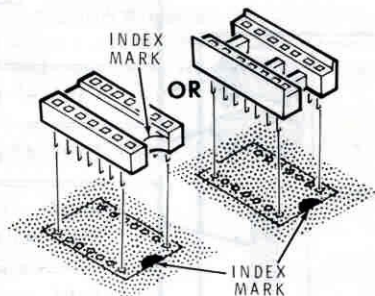

FOR GOOD SOLDER CONNECTIONS, YOU MUST **KEEP THE SOLDERING IRON TIP CLEAN.**

WIPE IT OFTEN WITH A DAMP SPONGE OR CLOTH.

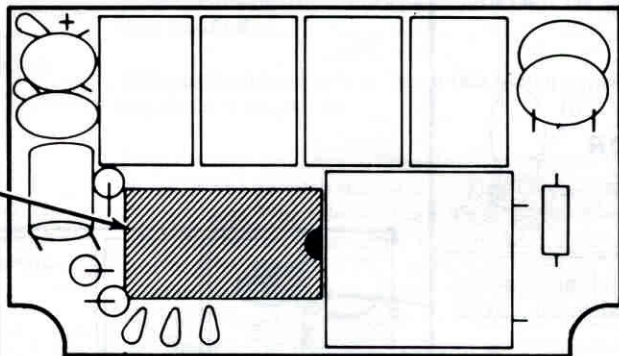

PICTORIAL 1-3

START 

When you install tantalum capacitors, always match the positive (+) mark or dot on the capacitor with the positive (+) mark on the circuit board.

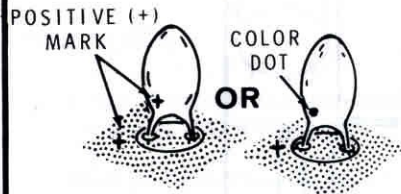

- () C101: 10 μ F tantalum capacitor. Install it vertical to the circuit board.

NOTE: When you install ceramic capacitors, do not push the insulated portion of the leads into the circuit board holes. This could make it difficult to solder the leads to the foil.

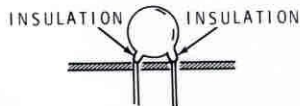

- () C102: 10 pF ceramic capacitor.

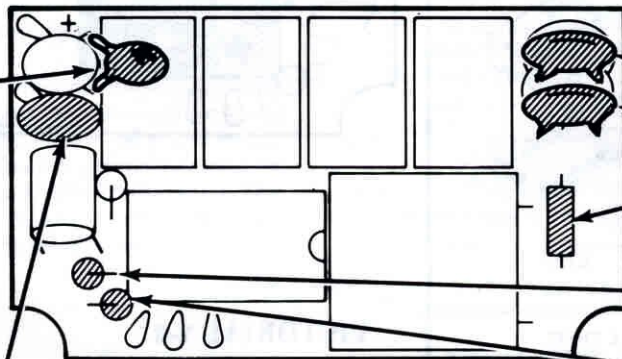

PICTORIAL 1-4

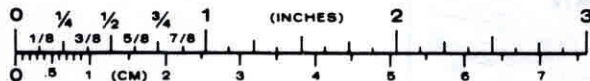
**CONTINUE** 

Position the next two ceramic capacitors approximately 1/16" above and vertical to the circuit board.

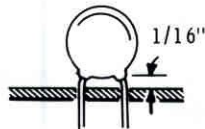

- () C103: 47 pF ceramic capacitor.

- () C104: 47 pF ceramic capacitor.

- () R102: 11 M Ω (brown-brown-blue) resistor.

- () R104: 8200 Ω (gray-red-red) resistor.

- () R103: 1000 Ω (brown-black-red) resistor.

- () Solder the leads to the foil and cut off the excess lead lengths.

START ↩

() SW101, SW102, SW103, SW104: Install four slide switches. Then solder **one** lead of each switch to the foil. Check the switches to see that they are mounted evenly. (Reheat the solder connection and align the switches if necessary.) Solder the remaining switch lugs to the foil. **NOTE:** The switch lugs support the switches above the circuit board.

() C105: 0.01 μ F Mylar capacitor. Position the capacitor bottom approximately 1/16" above the circuit board. Solder the leads to the foil and cut off the excess lead lengths. Position the capacitor vertical to the circuit board.

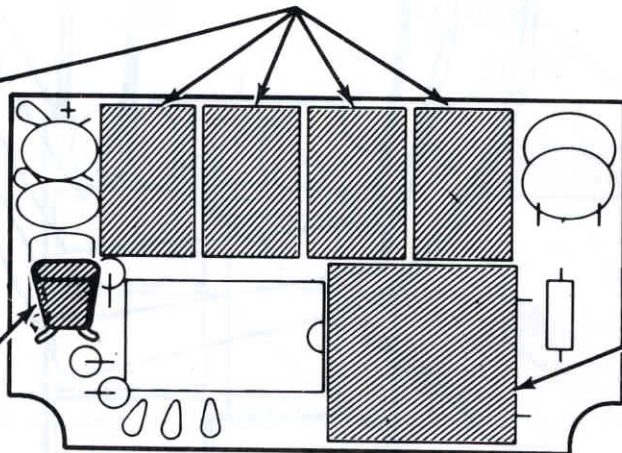
**CONTINUE** ↩

() Y101: 377.616 kHz crystal (#404-577). Bend the leads over sharply and mount the crystal to the circuit board so the crystal body is tight against the circuit board. Then solder the leads to the foil and cut off the excess lead lengths. **CAUTION:** Do not let the leads touch the metal case of the crystal.

PICTORIAL 1-5

START ↘

NOTE: When you are instructed to prepare a wire, cut it to the indicated length and remove 1/4" of insulation from each end. Then twist the small wire strands together and melt a small amount of solder on the bare wire ends to hold the wire strands together.

() Prepare the following wires:

- 4-1/2" orange
- 6" brown
- 6-1/2" gray
- 6-1/2" blue
- 6-3/4" violet

In the following steps, connect one end of each wire to the circuit board, solder the wires to the foil, and cut off the excess wire lengths on the foil.

PICTORIAL 1-6

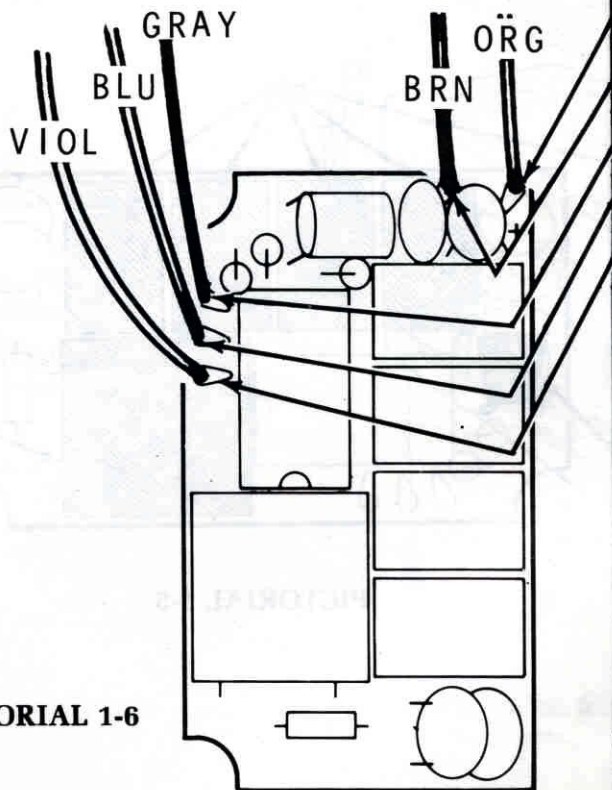
**CONTINUE** ↘

- () 4-1/2" orange wire to hole A.
- () 6" brown wire to hole B.
- () 6-1/2" gray wire to hole C.
- () 6-1/2" blue wire to hole D.
- () 6-3/4" violet wire to hole E.

CIRCUIT BOARD CHECKOUT

Carefully inspect the circuit board for the following conditions.

- () Unsoldered connections.
- () Poor solder connections.
- () Solder bridges between foil patterns.
- () Protruding leads which could touch together.
- () Capacitor for the correct position of the positive (+) end.

Temporarily set the circuit board aside.

RF OSCILLATOR CIRCUIT BOARD

START 

- () Position the RF oscillator circuit board (#85-1790-1 or 85-1924-1) as shown with the foil side down.
- () R13: 47 k Ω (yellow-violet-orange) resistor.
- () R14: 220 Ω (red-red-brown) resistor.
- () R15: 82 k Ω (gray-red-orange) resistor
- () R19: 3900 Ω (orange-white-red) resistor.
- () R20: 3900 Ω (orange-white-red) resistor.
- () Solder the leads to the foil and cut off the excess lead lengths.

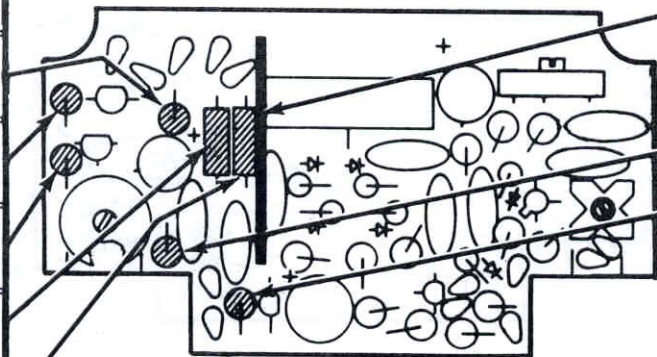

PICTORIAL 2-1

CONTINUE 

- () Prepare a 1-3/8" length of orange wire. Install the wire and solder the ends to the foil. Cut off the excess wire lengths. Do not shorten the indicated wire length.
 - () R16: 22 k Ω (red-red-orange) resistor.
 - () R1: 33 k Ω (orange-orange-orange) resistor.
 - () Solder the leads to the foil and cut off the excess lead lengths.
- NOTE: Because of the parts density, you may want to solder each part as you install it in the following steps.

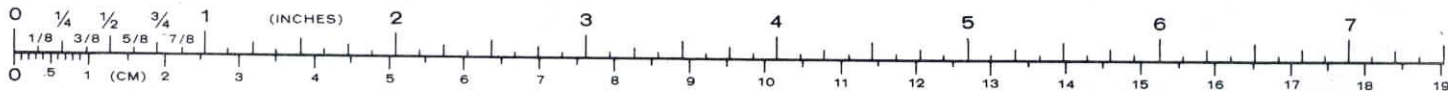

START ▾

Install the next two diodes with the three color bands up, away from the circuit board.

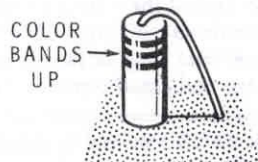

() D4: 1N295 (red-white-green) diode (#56-20).

() D3: 1N295 (red-white-green) diode (#56-20).

() Solder the leads to the foil and cut off the excess lead lengths.

IMPORTANT: THE BANDED END OF DIODES CAN BE MARKED IN A NUMBER OF WAYS.

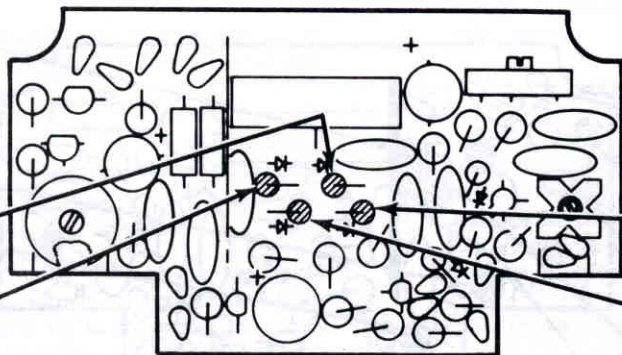

PICTORIAL 2-2

CONTINUE ▾

Install the next two diodes with the color bands down, near the circuit board.



() D6: 1N295 (red-white-green) diode (#56-20).

() D5: 1N295 (red-white-green) diode (#56-20).

() Solder the leads to the foil and cut off the excess lead lengths.

START ▾

- () C12: 0.01 μ F ceramic capacitor. Position the jumper wire up, away from the capacitor leads.
- () C11: 420 pF ceramic capacitor.
- () C10: 420 pF ceramic capacitor.
- () R12: 150 Ω (brown-green-brown) resistor.
- () R10: 150 Ω (brown-green-brown) resistor.
- () R2: 15 k Ω (brown-green-orange) resistor.
- () R3: 11 M Ω (brown-brown-blue) resistor.
- () R5: 4700 Ω (yellow-violet-red) resistor.
- () Solder the leads to the foil and cut off the excess lead lengths.

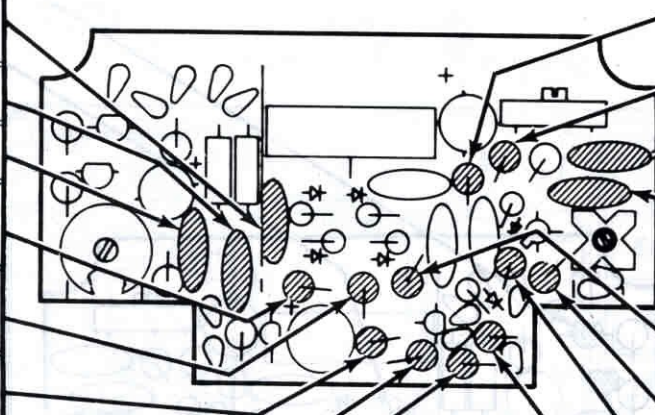
**CONTINUE** ▾

- () R8: 150 Ω (brown-green-brown) resistor.
- () R9: 2200 Ω (red-red-red) resistor.
- () C3: 270 pF ceramic capacitor.
- () C4: 15 pF ceramic capacitor. NOTE: Install an 18 pF ceramic capacitor for channel 3 operation.
- () R11: 33 Ω (orange-orange-black) resistor.
- () R6: 100 k Ω (brown-black-yellow) resistor.
- () R7: 470 Ω (yellow-violet-brown) resistor.
- () R4: 11 M Ω (brown-brown-blue) resistor.
- () Solder the leads to the foil and cut off the excess lead lengths.

PICTORIAL 2-3

START 

NOTE: The following three transistors may be either one of the three types shown below. In each step, if the transistor body has a flat and its leads are in-line, align the transistor flat with the outline on the circuit board, and if necessary, bend the center lead back away from the flat. If the transistor leads are staggered, bend the center lead back through the wide-spaced leads and position the wide-spaced leads away from the flat on the circuit board. Then insert the leads into their correct holes, indicated by E, B, C. Position the transistor body 1/8" above the circuit board, solder the leads to the foil, and cut off the excess lead lengths.

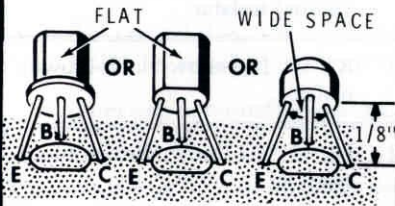

() Q5: MPSA20 transistor (#417-801).

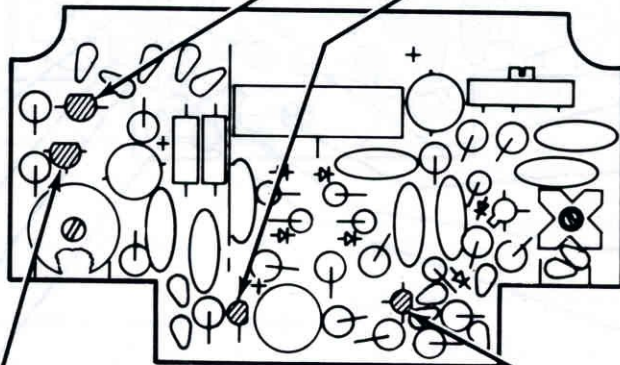

PICTORIAL 2-4

CONTINUE 

() Q4: 2N4121 transistor (#417-235).

() Q2: 2N4121 transistor (#417-235).

The following transistor may be either one of the two types shown below. Determine which type you received and position it with the wide lead spacing toward the outline of the flat on the circuit board. Then insert the leads into their correct holes, indicated by G, D, S. Position the transistor body 1/8" above the circuit board, solder the leads to the foil, and cut off the excess lead lengths.

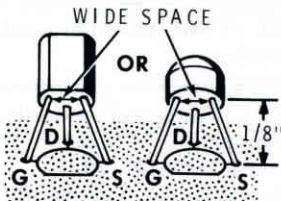

(✓) Q3: TIS75 transistor (#417-806).

START ◀

- () Locate the #417-167 transistor and cut off the case lead at the body of the transistor. Then carefully bend the locating tab up against the case.

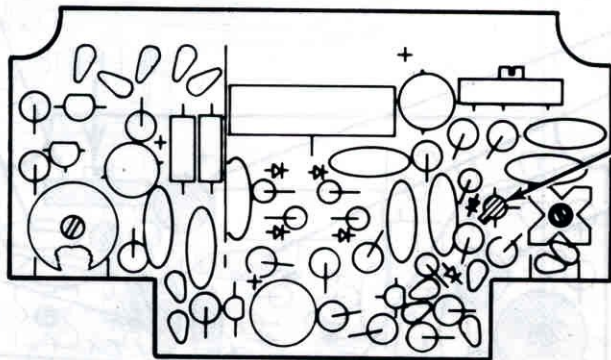
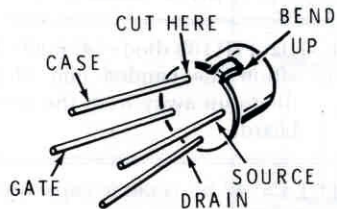
**CONTINUE** ▶

- (-) Q1: #417-167 transistor. Position the transistor so the locating case tab matches the outline on the circuit board. Then insert the leads into their correct holes, indicated by G, D, S. Position the transistor body 1/8" above the circuit board, solder the leads to the foil, and cut off the excess lead lengths. DO NOT let the case touch any other components.

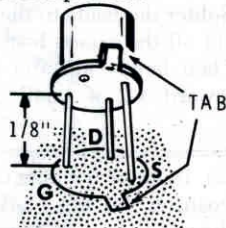

PICTORIAL 2-5

START 

NOTE: When you install a tantalum capacitor, always match the positive (+) mark or dot on it with the positive (+) mark on the circuit board.

() C2: 10 μ F tantalum capacitor.

() C6: 0.01 μ F ceramic capacitor.

() C1: 47 μ F tantalum capacitor.

() C8: 10 μ F tantalum capacitor.

() Solder the leads to the foil and cut off the excess lead lengths. Then bend capacitor C1 over toward C2 a small amount.

() C9: 15-60 pF trimmer capacitor. Position the lug marked with the arrow toward the center of the circuit board. Hold the trimmer tightly against the board and then solder the lugs to the foil.

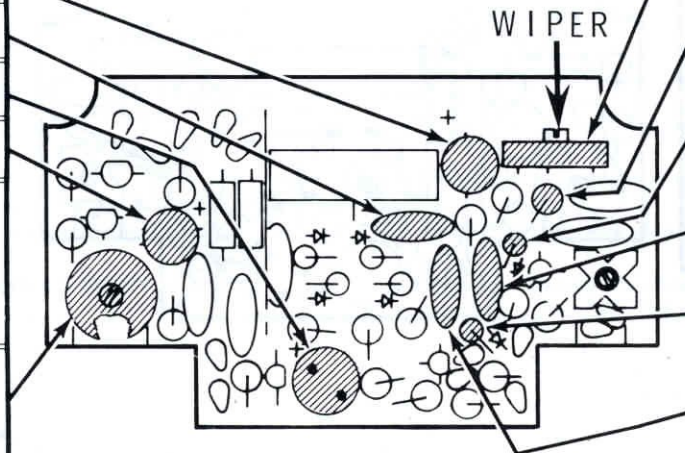

PICTORIAL 2-6

CONTINUE 

() R18: 1000 Ω control. Mount the control vertical to the circuit board with the wiper arm toward the outside of the circuit board, as shown. Solder the leads to the foil and cut off the excess lead lengths.

() L1: 10 μ HRF choke (#45-57).

() D2: FH1100 diode (#56-87). Position the banded end of the diode up away from the circuit board.

() C5: 47 pF ceramic capacitor.

() D1: 1N4149 diode (#56-56). Position the banded end of the diode up away from the circuit board.

() C7: 20 pF ceramic capacitor.

() Solder the leads to the foil and cut off the excess lead lengths.

NOTE: You will install the 3.3 pF ceramic capacitor later.

START 

() R17: 3000 Ω control. Mount the control vertical to the circuit board and solder the lugs to the foil.

() Y2: 3563.795 kHz crystal (#404-578). Mount the crystal so the leads extend 3/4" above the circuit board. Then solder the leads to the foil and cut off the excess lead lengths from the foil side. Bend the crystal over so the center of the crystal body rests against the edge of the circuit board and the leads do not touch the metal case. Refer to Detail 2-7A.

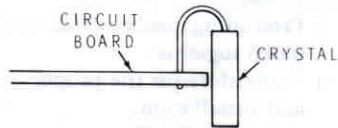
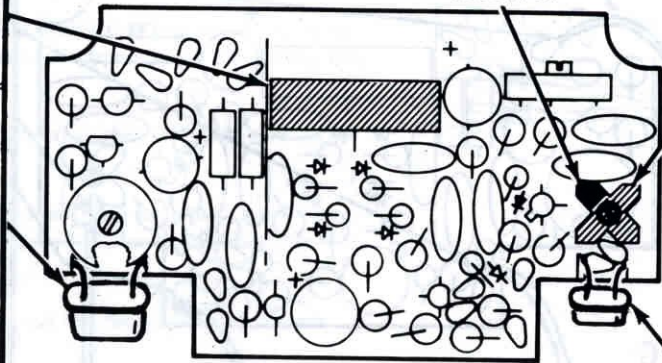
**Detail 2-7A**INDEX
MARK**PICTORIAL 2-7****CONTINUE** 

() L2: 72 MHz output inductor. Align the painted mark on the inductor with the index mark on the circuit board. Then mount the inductor and solder the leads to the foil. Then cut off the excess lead lengths. Be sure to press the inductor body tightly against the circuit board.

() Y1: 67.25 MHz crystal (#404-341). Mount the crystal so the leads extend 3/4" above the circuit board. Then solder the leads to the foil and cut off the excess lead lengths from the foil side. Bend the crystal over so the center of the crystal body rests against the edge of the circuit board and the leads do not touch the metal case.

NOTE: Install a 61.25 MHz crystal for channel 3 operation.

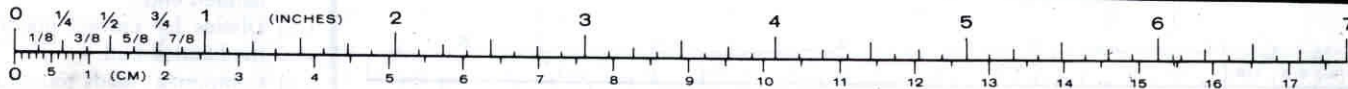

START 

() Prepare the following wires:

- 5-1/4" orange
- 3-1/4" red
- 2-3/4" brown
- 2-1/2" white

In the following steps, connect one end of each wire to the circuit board, solder the wires to the foil, and cut off the excess wire lengths on the foil side.

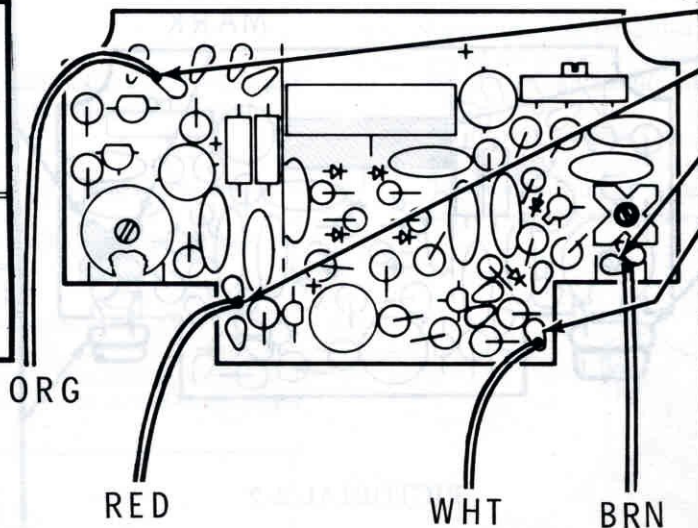

PICTORIAL 2-8

CONTINUE 

- () 5-1/4" orange wire to hole B.
- () 3-1/4" red wire to hole H.
- () 2-3/4" brown wire to hole P.
Route the wire over the crystal.
- () 2-1/2" white wire to hole N.

CIRCUIT BOARD CHECKOUT

Carefully inspect the circuit board for the following conditions.

- () Unsoldered connections. Disregard unused holes.
- () Poor solder connections.
- () Solder bridges between foil patterns.
- () Protruding leads which could touch together.
- () Transistors for the proper type and installation.
- () Capacitors for the correct position of the positive (+) or banded end.
- () Diodes for correct position of the banded end.
- () Component leads touching adjacent component leads.



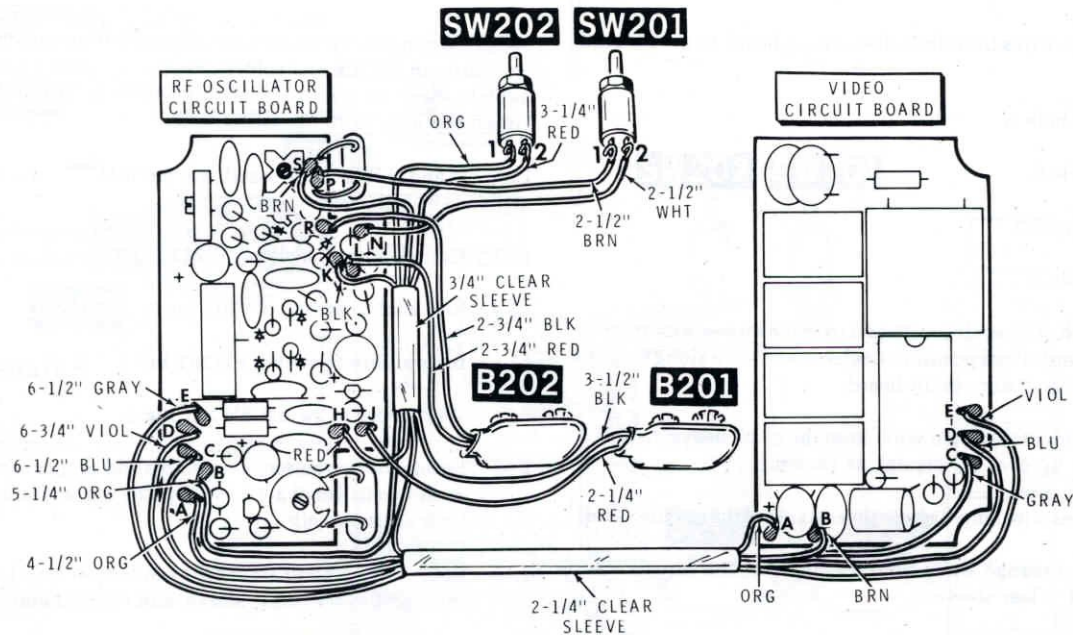

FINAL WIRING

PICTORIAL 3-1

Refer to Pictorial 3-1 for the following steps.

() Position the video circuit board and RF oscillator circuit board as shown.

() Cut a 2-1/4" length of clear sleeve. Then pass the five wires from the video circuit board through the sleeve.

Connect and solder the wires from the video circuit board to the RF oscillator circuit board.

- Orange wire to hole A.
- Blue wire to hole C.
- Violet wire to hole D.
- Gray wire to hole E.
- Cut a 3/4" length of clear sleeve. Pass it over the brown wire from the video circuit board. Then position the sleeve and wire along the right edge of the RF oscillator circuit board.
- Connect and solder the brown wire, from the clear sleeve, to hole S. Route this wire up over the crystal, as shown.
- Cut off any excess wire lengths from the foil side of the circuit board.
- Pass the red and orange wires from the RF oscillator circuit board through the 3/4" clear sleeve.
- Locate the two pushbutton switches.

NOTE: When you connect a wire to a pushbutton switch, carefully wrap the wire around the lug and solder. After you connect wires to both lugs of a switch, carefully examine the connections to insure there is no short between the lugs, or to the switch case.

Connect and solder the RF oscillator circuit board wires to the pushbutton switches as follows:

- Orange wire to switch SW202 lug 1.
- Red wire to switch SW202 lug 2.
- Brown wire to switch SW201 lug 1.
- White wire to switch SW201 lug 2.
- Locate the two battery connectors and prepare the wires on each one as shown in Detail 3-1A. NOTE: The wires may be presoldered along their entire length.
- B201: Connect and solder the red wire at hole J. Pass the black wire through the 3/4" clear sleeve, and connect and solder it at hole K.
- B202: Connect and solder the red wire at hole L, and the black wire at hole R. Do not pass these wires through the 3/4" clear sleeve.
- Cut off the four excess wire lengths from the foil side of the circuit board.

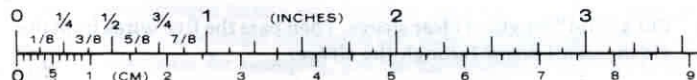

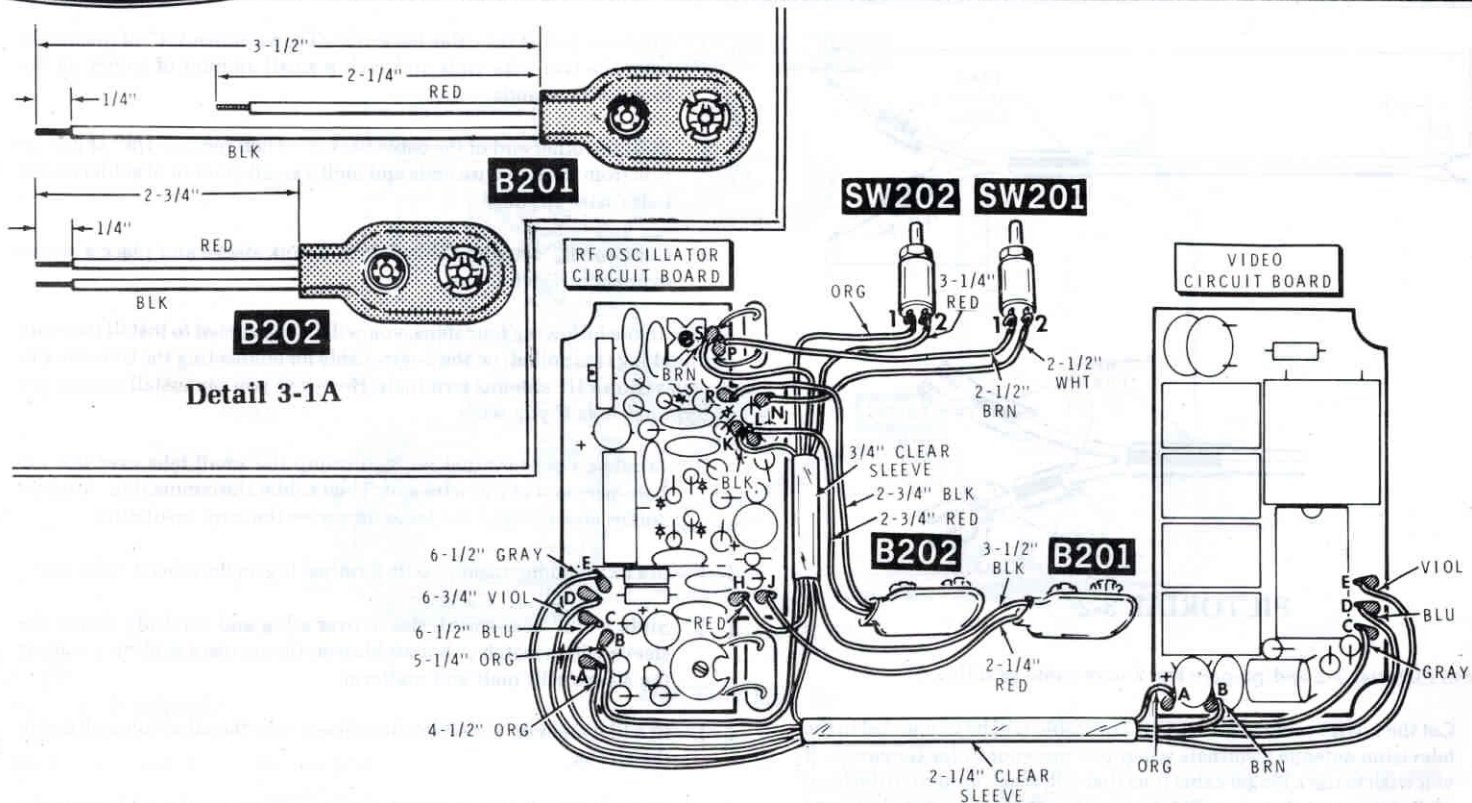

PICTORIAL 3-1 (Repeat)

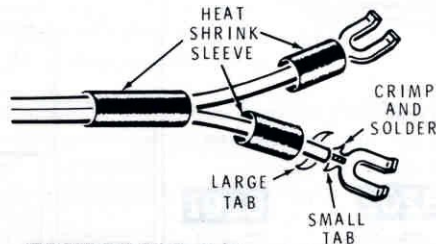
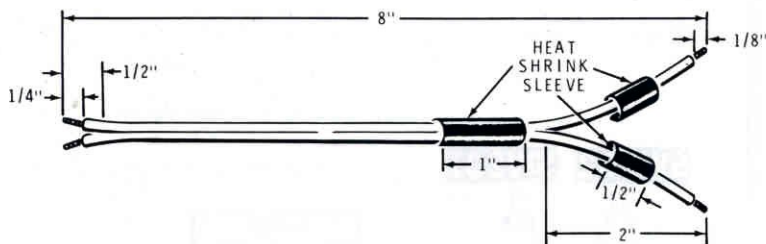

PICTORIAL 3-2

Refer to Pictorial 3-2 and prepare the 2-wire cable as follows:

- () Cut the 2-wire cable to 8". NOTE: This cable will be connected to the television antenna terminals when you use your Color Generator. If you wish to use a longer cable (one that will reach around to the front of the television, for example), you can use standard 2-wire line cord in place of the 2-wire cable supplied.

- () Split one end of the cable back 1/2". Then remove 1/8" of insulation from the two wire ends and melt a small amount of solder on the loose wire strands.
- () Split the other end of the cable back 2". Then remove 1/8" of insulation from the two wire ends and melt a small amount of solder on the loose wire strands.
- () Cut two 1/2" lengths of black heat-shrink sleeve and place a sleeve over each 2" wire end.

NOTE: In the following four steps, you will be instructed to install two wire terminal lugs (supplied) on the 2-wire cable for connecting the Generator to the television VHF antenna terminals. However, you can install other types of terminal lugs if you wish.

- () Locate a wire terminal lug and crimp the small tabs over the 1/8" bare-wire end of a 2" wire end. Then solder the connection. After the solder cools, crimp the large tabs over the wire insulation.
- () In a like manner, install a wire terminal lug on the other 2" wire end.
- () Slide a 1/2" heat-shrink sleeve over a lug and carefully shrink the sleeve with a match or hot-air blower. Do not use a soldering iron, as the sleeve will melt and malform.
- () In a like manner, slide the other sleeve over the other lug and shrink the sleeve.
- () Cut a 1" length of heat-shrink sleeve, pass it over the cable up to the end of the 2" split, and shrink the sleeve.

Refer to Pictorial 3-3 and install the prepared 2-wire cable on the foil side of the RF oscillator circuit board.

- () Insert either 1/4" bare wire end into hole G so that about 1/8" of the bare end is visible on the foil side of the circuit board. Then solder the wire to the foil.
- () In a like manner, insert and solder the other 1/4" bare-wire end at hole F.
- () Carefully check to see that all connections have been soldered on both circuit boards, and there are no solder bridges between foil patterns.
- () Fold the 2-wire cable down against the circuit board as shown.
- () Cut both leads of the 3.3 pF ceramic capacitor to 1/8".
- () C13: Refer to the inset drawing and solder the capacitor to the indicated foils. Be sure the capacitor is down flat against the circuit board.

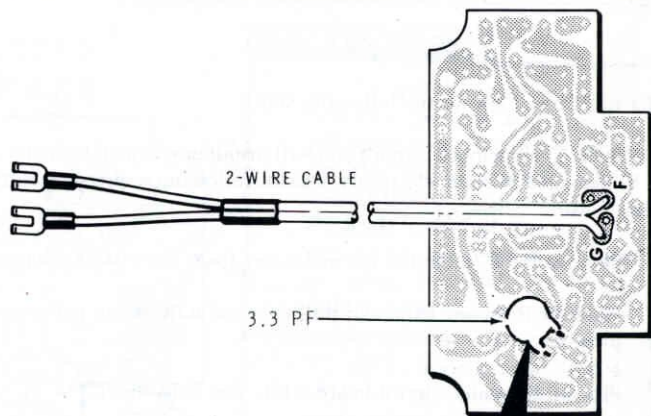

PICTORIAL 3-3

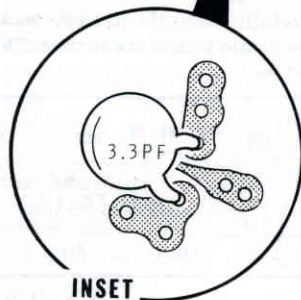

INSET

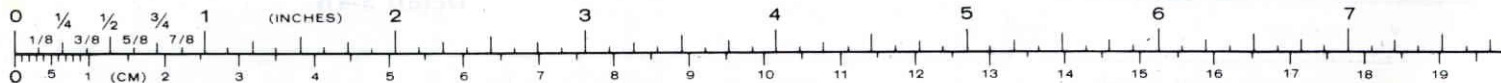

Refer to Pictorial 3-4 for the following steps.

CAUTION: The integrated circuit you will install next is a MOS device that can be damaged by static electricity. Use the following sequence when you install IC101.

1. Remove the IC mounted in conductive foam from its envelope.
2. Hold the IC in one hand and pull the conductive foam pad from the pins.
3. Pick up the video circuit board while you hold the IC.
4. Carefully insert the IC in its socket before you set the circuit board down onto your work surface. The IC is now protected by the socket and foil.

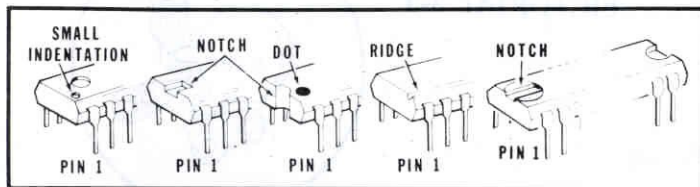

Detail 3-4A

- () Locate the 5322 integrated circuit (#442-624). Note that the integrated circuit can be marked in any one of several ways. Refer to Detail 3-4A and identify pin 1.
- () IC101: 5322 integrated circuit (#442-624). Position the pin 1 end of this integrated circuit toward the index mark on the circuit board. Then carefully install the integrated circuit. Make sure all the pins are in their respective holes.

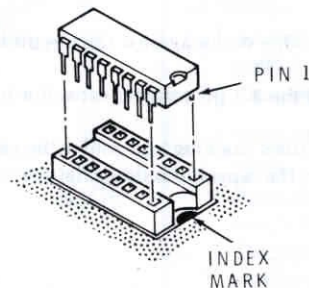

Detail 3-4B

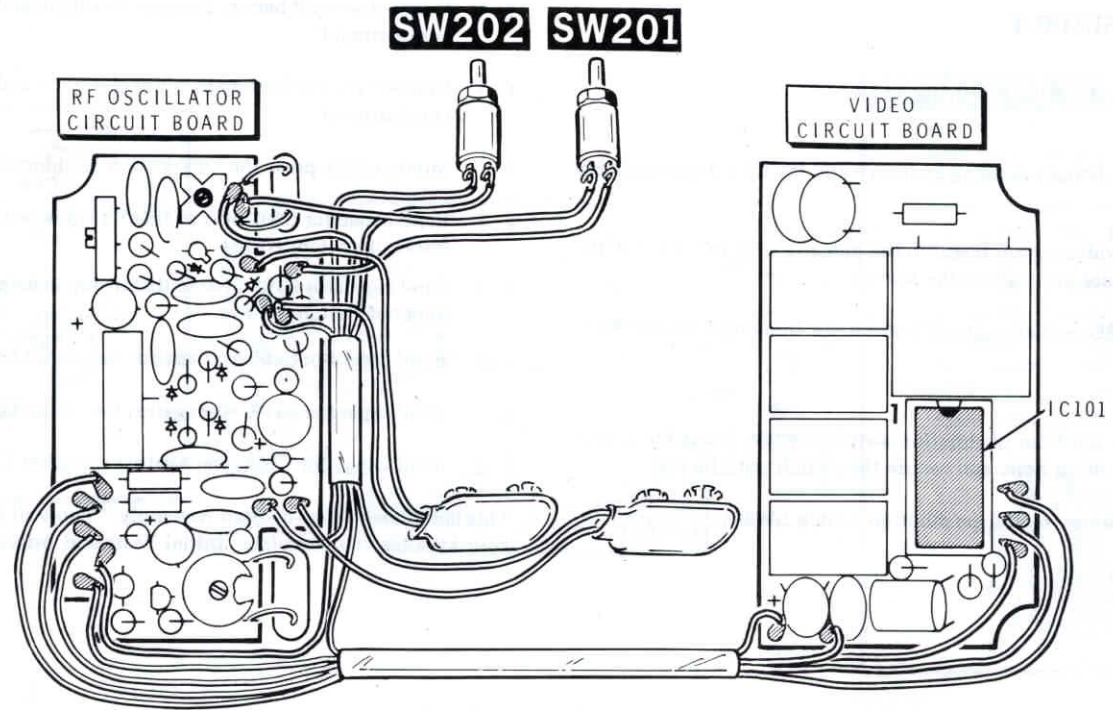

PICTORIAL 3-4

HOUSING ASSEMBLY

Refer to Pictorial 4-1 for the following steps.

- () Position the bottom housing as shown and lay the circuit assembly on it.
- () Secure the video circuit board to the housing with two #2 × 3/16" screws. Do not overtighten the screws.
- () Secure the RF oscillator circuit board to the housing with two #2 × 3/16" screws.
- () Remove the nut from pushbutton switch SW202, insert the switch into its mounting hole, and secure the switch with its nut.
- () In a like manner, mount pushbutton switch SW201.

- () Connect a 9-volt battery to connector B202 and lay the battery in its compartment.
- () Connect a 9-volt battery to connector B201 and lay the battery in its compartment.
- () Momentarily press the OFF switch pushbutton.
- () Bend capacitor C101 over so that its top is below the top edge of the frame of switch SW104.
- () Bend capacitor C102 over so that its top is below the top edge of the frame of switch SW104.
- () Bend capacitor C105 over against the circuit board mounting screw.
- () Bend capacitor C103 over against the circuit board mounting screw.
- () Bend capacitor C104 over against capacitor C103.

This completes "Step-by-Step Assembly." You will finish the assembly of your kit after you complete "Initial Tests and Adjustments."

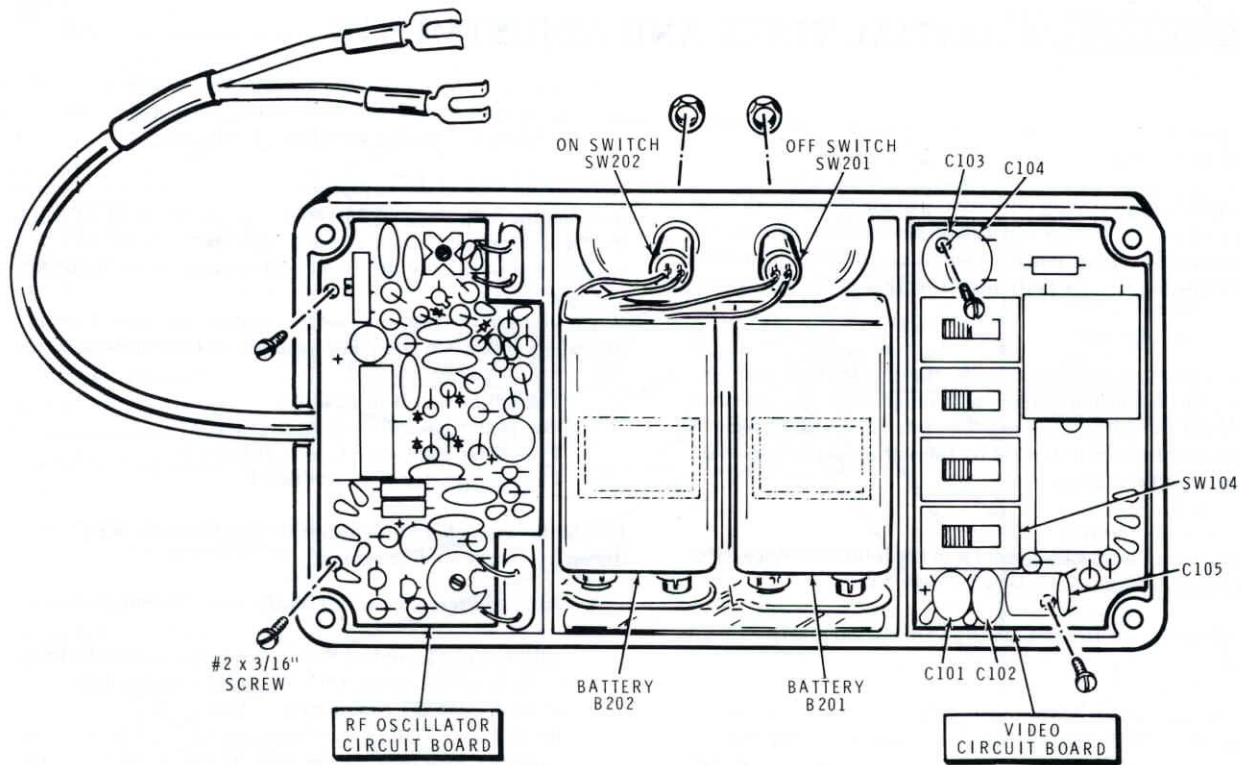

PICTORIAL 4-1

INITIAL TESTS AND ADJUSTMENTS

NOTES:

1. A properly aligned and operating color television set is required for alignment of the Generator.
2. When the Generator is operating with the top housing removed, hand capacitance and stray radiation may distort the selected pattern display on the television screen. It may be necessary to lay the Generator down and/or position it in a particular direction after each adjustment.
3. The number of vertical and/or horizontal lines, color bars, and dots displayed on the television screen will depend on the overscan characteristics of the television used. The intensity ratio of vertical lines to horizontal lines will depend on the setting of the television video peaking and fine tuning.
4. If you do not obtain the specified results in the following steps, refer to the "In Case of Difficulty" section on Page 45.
 - () Turn your television set on and tune in a VHF station that has a good color signal.
 - () Switch off the user accessible automatic control circuits (automatic fine tuning, etc.). With these controls off, adjust the fine tuning, color, tint, contrast, and brightness controls for a good picture with correct flesh tones.

- () Disconnect the VHF antenna from the television set and connect the Generator 2-wire cable in its place. Then turn the television channel selector to channel 4 (channel 3 optional).

NOTE: The four slide switches on the video circuit board are used to program the output signal. The switch positions are identified by a 1 and a 0. When a switch is in position 1, the switch lever will be toward the batteries; in position 0, the lever will be away from the batteries.

When you are instructed to select a signal, the switch positions will be identified with a 1/0 code. For example, "1010" indicates that:

- The left switch is in position 1.
- The center left switch is in position 0.
- The center right switch is in position 1.
- The right switch is in position 0.

Locate the trim label; it identifies the approximate television picture produced by each switch program.

- () Refer to Figure 3 and preset the controls and switches as follows:

- VIDEO LEVEL control R18 — 3/4-turn counterclockwise.
- COLOR LEVEL control R17 — Fully counterclockwise.
- COLOR ADJUST trimmer C9 — Disregard.
- RF OSCILLATOR control inductor L2 — With the alignment tool supplied, turn the slug out until its end is flush with the end of the coil form.

- Program switch SW104 — 1.
- Program switch SW103 — 0.
- Program switch SW102 — 1.
- Program switch SW101 — 0.
- ON pushbutton switch SW202 — Disregard.
- OFF pushbutton switch SW201 — Press momentarily.

- () Switch the Generator on (momentarily press ON pushbutton switch). Either a blank raster or snow will be displayed on the picture tube. If a blank raster display is visible, turn the tuning slug of RF Oscillator control inductor L2 out of the end of the coil form until a snow pattern is displayed. NOTE: After a period of time (five minutes minimum), the Generator will turn itself off. If you have not completed the test when this occurs, switch the Generator on again.
- () Slowly turn the tuning slug of inductor L2 clockwise until you observe a blank raster on the picture tube. Note the position of the slug. Then adjust the slug 1/4-turn clockwise. NOTE: It may be necessary to readjust the television fine tuning to produce a blank raster.
- () Switch the Generator off (momentarily press the OFF pushbutton switch). The blank raster should disappear.
- () Switch the Generator on. The blank raster should reappear.

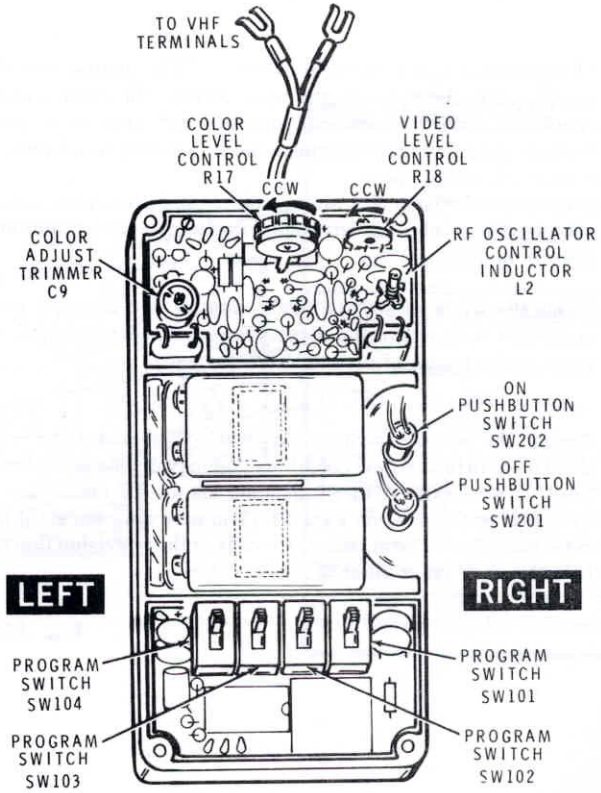

Figure 3

- () Change the program switches to "0101." The picture tube should display vertical and horizontal lines. NOTE: The vertical and horizontal lines may not have equal intensity, and it may be necessary to readjust the television brightness and fine tuning to see both lines.
 - () Adjust the television fine tuning control and brightness control for maximum line intensity with equal line widths, and minimum line distortion.
 - () Rotate the wiper of VIDEO LEVEL control R18 through its entire range and note where the display begins to distort. Then set the wiper to the center of its undistorted range.
 - () Change the program switches to "0001." The picture tube should display up to ten vertical color bars that may or may not have a color hue. Turn COLOR ADJUST trimmer C9 so the color bars are as indicated in Figure 4 on Page 43. (You may only see eight or nine color bars.) It may be necessary to readjust the television fine tuning, color level, or color killer to obtain color.
 - () Adjust the television fine tuning, inductor L2, and control R18 for minimum display distortion.
 - () Turn trimmer C9 through its entire range and note where the color disappears from the display. Then set the trimmer to the center of its color range.
- NOTE: It may be necessary to fine tune the television when switching between color and black and white patterns.
- () Using the trim label as a reference, program each of the sixteen output signals to verify their operation. NOTE: The illustrations showing more than one dot, horizontal line, vertical line, or cross-hatch indicate only the relative density of the pattern. They do not indicate the exact number displayed.
 - () Press the OFF pushbutton.
- This completes "Initial Tests and Adjustments." Proceed to "Final Assembly."

FINAL ASSEMBLY

Refer to Pictorial 5-1 for the following steps.

- () Position the housing top as shown.
- () Remove the paper backing from one side of a foam pad. Press the pad onto the inside of the housing in the corner formed by the side of the housing and the ridge.
- () Remove the paper backing from the blue and white label, and press the label onto the inside of the housing next to the foam pad. Be sure to refer to the numbers on this label in any communication you have with the Heath Company about this kit.
- () Remove the paper backing from one side of the remaining foam pad, and press the pad onto the inside of the housing next to the blue and white label and the ridge.

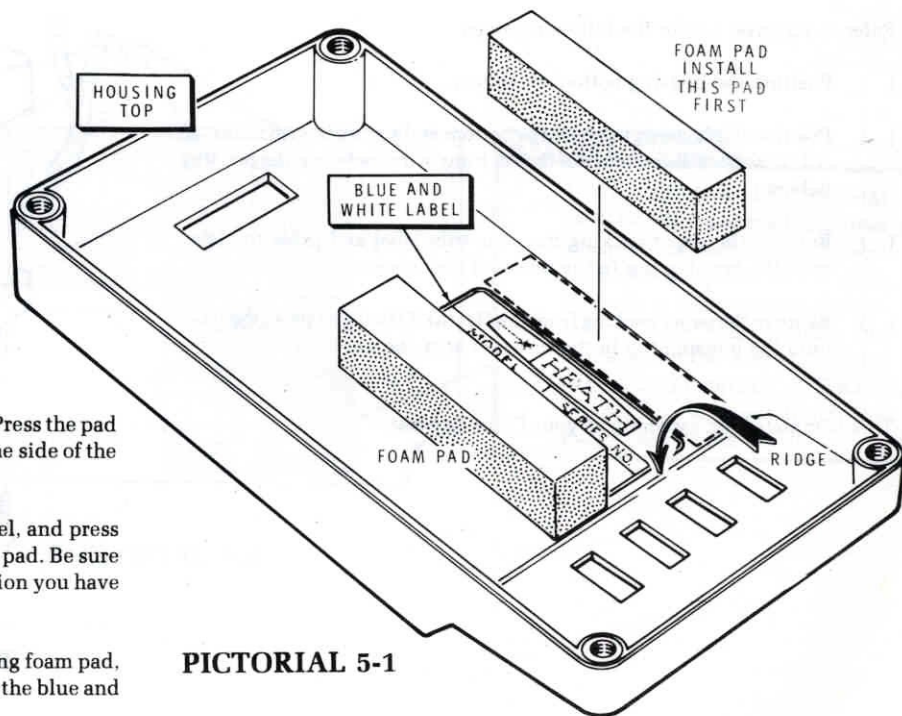

PICTORIAL 5-1

Refer to Pictorial 5-2 for the following steps.

- () Position the housing bottom as shown.
- () Position the housing top over the bottom and secure it with four 4-40 \times 1/2" screws. Be careful not to pinch any wires between the housing halves.
- () Remove the paper backing from the trim label and press the label onto the housing top in the recessed area shown.
- () Remove the paper backing from the Heathkit label and press the label onto the housing top in the recessed area shown.

This completes the assembly of your Color Generator.

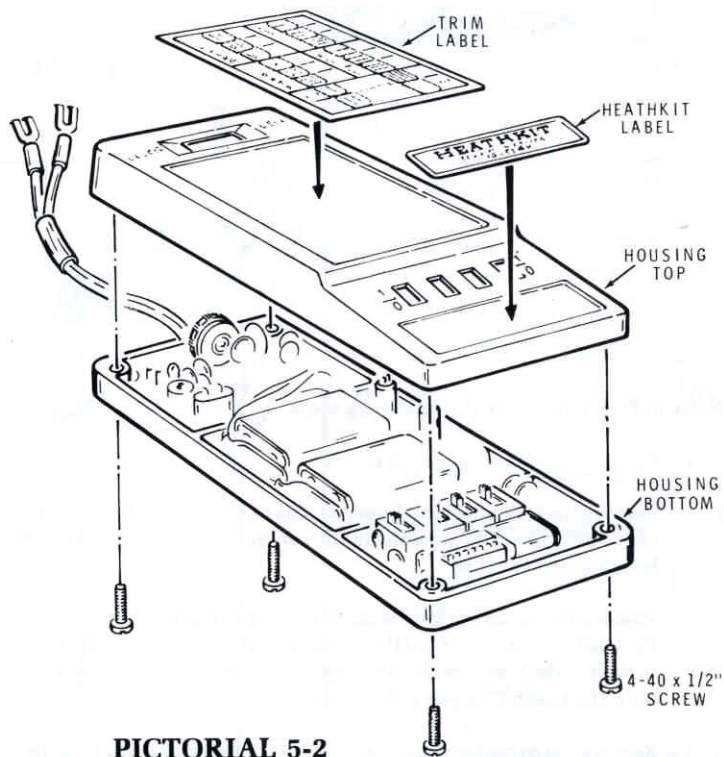

PICTORIAL 5-2

OPERATION

The Model IG-5240 Color Generator is a 16-function instrument capable of supplying the modulated RF signals necessary for television alignment. The RF carrier frequency is calibrated for channel 4 (channel 3 can be incorporated as an option). A unique control circuit* turns the Generator off after a 5-minute (minimum) interval. This helps to conserve battery power if the generator is accidentally left on.

BATTERY

Two 9-volt transistor batteries, NEDA #1604, are required for operation. To install: Remove the four screws that secure the housing halves, clip a battery to each connector, and resecure the two housing halves. Be careful not to pinch any wires.

Representative battery manufacturers and their type numbers are:

Eveready #216, P3
 Burgess #2V6
 Mallory #TR-146X (long life)
 RCA #VS323
 Hellekens #410
 Varta #438
 CEI #6F22

*Patent Pending

SWITCHES-CONTROL-OUTPUT

ON pushbutton switch — The Generator is turned on when this button is pressed momentarily. After a period of at least 5 minutes, the Generator will turn itself off.

OFF pushbutton switch — When this button is pressed momentarily, the Generator is turned off.

Program slide switches — These four switches are used to select the output signal. When a switch slide is moved toward the large trim label, it is in the "1" position. When the switch slide is moved toward the small Heathkit label, it is in the "0" position. The trim label illustrates the various signals that can be displayed on a television. Next to each illustration is the required switch program. **NOTE:** The illustrations on the trim label showing multiple patterns are only representative and do not show actual pattern density. The three color patterns are a rainbow (1111), three color bars (1100), and ten color bars (0001). Figure 4 illustrates the ten bar color sequence. You may not see all ten color bars on some television sets.

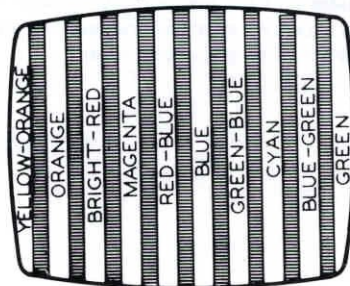

Figure 4

COLOR LEVEL control — Adjusts the color intensity of the three color patterns.

Output cable — Use to connect the generator signal to the VHF terminals of the television set. This is the only connection required. **NOTE:** The RF carrier frequency is calibrated for channel 4.

USER NOTES

1. Switch off the user accessible automatic control circuits (automatic fine tuning, etc.) while using the Color Generator.
2. When you switch between color and black and white patterns, it may be necessary to fine tune the television for best pattern display.
3. Successful use of the Color Generator requires a properly operating television. You may find, in some older televisions, a particular characteristic that distorts the Generator patterns and cannot be corrected by fine tuning the television. You can generally correct the problem by adjusting oscillator coil L2, inside the Generator. This problem is usually caused by excessive sync requirements, or improper adjustment of the IF and RF AGC in the television.

ALTERNATE CHANNEL OPERATION

The RF oscillator crystal of this Generator is selected for channel 4. If you encounter local interference on channel 4 (channel 4 television transmitter in your area), you can order an alternate crystal for channel 3 from a number of crystal manufacturers. This crystal is now available from the Heath Company under part number 404-601. The following is a list of specifications for the crystal in case you want to purchase it from a crystal manufacturer.

Case Style — HC-18.

Nominal Frequency — 61.25 MHz.

Frequency Tolerance — 0.005%.

Mode of Operation — Fifth overtone.

Maximum Crystal Output Capacitance — 7 pF.

Maximum Series Resistance — 80 Ω .

Load Capacitance — 13 pF.

Drive Level — 2 mW into 60 Ω .

For channel 3 operation, replace crystal Y1 (67.25 MHz) with a 61.25 MHz crystal and replace capacitor C4 (15 pF) with an 18 pF (part number 21-60) ceramic capacitor.

IN CASE OF DIFFICULTY

This part of the Manual will help you locate and correct any difficulty that might occur in your Generator. This information is divided into two sections. The first, "General Tests," suggests the visual checks and inspection that may help you locate your problem.

The second section consists of a "Troubleshooting Chart." This chart calls out specific problems that may occur and lists one or more conditions or components that could cause each difficulty. The component numbers used in this chart are the same numbers that are used on the Schematic. "Circuit Board X-Ray Views" on Page 52 also provide help in locating the difficulty.

NOTE: In an extreme case where you are unable to resolve a difficulty, refer to the "Customer Service" information inside the rear cover of the Manual. Your "Warranty" is inside the front cover.

GENERAL TESTS

1. Recheck the wiring. It is frequently helpful to have a friend check your work. Someone who is not familiar with the unit may notice something consistently overlooked by the builder.
2. About 90% of the kits that are returned for repair do not function properly due to poor connections and soldering. Therefore, many troubles can be eliminated by checking all connections to make sure that they are soldered correctly. Reheat the connections if necessary, but be careful not to create any solder bridges.
3. Check the values of all the parts. Be sure that the proper part has been installed at each location on the circuit board.
4. Check for bits of solder, wire ends, or other foreign matter which may be lodged in the components on the circuit boards.
5. Check very carefully to be sure there are no solder bridges between different circuit board foils.
6. If, after careful checks, the trouble is still not located and a voltmeter is available, check the voltage readings in the circuits against those shown on the Schematic.
7. A review of the "Circuit Description" and Schematic may also help you to locate any difficulties in the kit.

Troubleshooting Chart

PROBLEM	POSSIBLE CAUSE
Generator will not turn on, or will not remain turned on.	<ol style="list-style-type: none">1. Batteries B201 and/or B202 discharged.2. Switch SW202 defective or incorrectly wired.3. Transistor Q2 or Q3 defective.4. Diode D1 reversed or defective.5. Capacitor C1 open.
Generator will not turn off using switch SW201.	<ol style="list-style-type: none">1. Switch SW201 defective or incorrectly wired.2. Resistor R5 open.3. Transistor Q2 shorted.
No RF output.	<ol style="list-style-type: none">1. Inductor L2 incorrectly adjusted.2. Crystal Y1 defective.3. Transistor Q1 defective.4. Capacitor C5 open.

PROBLEM	POSSIBLE CAUSE
RF output, but no video output (blank raster).	<ol style="list-style-type: none"> 1. Diode D2 defective. 2. Control R18 incorrectly adjusted, or defective. 3. Integrated circuit IC101 defective. 4. Crystal Y101 defective. 5. Raster switch program (1010) selected. 6. Circuit boards incorrectly wired.
RF and video output, but no color.	<ol style="list-style-type: none"> 1. Trimmer capacitor C9 incorrectly adjusted. 2. Crystal Y2 defective. 3. Control R17 turned fully clockwise, or defective. 4. Transistors Q4 or Q5 defective. 5. Diodes D3, D4, D5, or D6 defective. 6. Integrated circuit IC101 defective. 7. Improper Color Killer adjustment and/or operation in the television set. 8. Capacitor C12 open.

PROBLEM	POSSIBLE CAUSE
Improper video display patterns.	<ol style="list-style-type: none"><li data-bbox="882 357 1268 383">1. Integrated circuit IC101 defective.<li data-bbox="882 414 1268 492">2. Program switches SW101, SW102, SW103, or SW104 defective.

SPECIFICATIONS

Display Patterns*

Raster	Blank.
Horizontal Lines	1, 7, 15.
Vertical Lines	1, 11, 21.
Crosshatch	1 × 1 matrix. 7 × 11 matrix. 15 × 21 matrix.
Dots	1 × 1 matrix. 7 × 11 matrix. 15 × 21 matrix.
Rainbow	No luminance.
Gated Rainbow	3 bars with luminance. 10 bars with luminance.
Chroma Carrier	3563.795 kHz ±0.005%, crystal controlled.
Master Timer	377.616 kHz ±0.005%, crystal controlled.
RF Carrier	Channel 4; 67.250 MHz ±0.005%, crystal controlled. Customer option Channel 3; 61.250 MHz ±0.005%, crystal controlled.
RF Output Level	5000 μV minimum into 300 Ω.

*The density of the displayed pattern depends on the overscan characteristics of the television set.

Video Modulation Percentage	50% (approximately).
On Time Interval	5 minutes minimum. OFF pushbutton switch overrides time-out.
Power Requirements	Two 9-volt transistor batteries with 180 mAh capacity (NEDA #1604).
Dimensions	5.4" long \times 2.75" wide \times 1.15" high. (12.7 cm long \times 6.99 cm wide \times 2.91 cm high.)
Weight	0.5 lb (0.225 kg).

The Heath Company reserves the right to discontinue products and to change specifications at any time without incurring any obligation to incorporate new features in products previously sold.

CIRCUIT DESCRIPTION

The Color Generator is composed of four basic circuits. Each will be described as a separate function.

POWER SOURCE

Two 9-volt batteries supply a +18 volts to the RF, color, and video generator circuits through a switch and time delay circuit. FET Q3 is turned on when ON switch SW202 is pressed. This turns on pass transistor Q2. Capacitor C1 slowly charges, which slowly reduces the gate potential of Q3. When the gate-to-source voltage of Q3 reaches cutoff, Q3 will turn off. This turns Q2 off and disconnects the supply voltage from the remaining circuits. If OFF switch SW201 is pressed, Q3 is cut off and C1 is rapidly discharged.

RF OSCILLATOR

FET Q1 and its associated components form a 67.250 MHz (channel 4 frequency) oscillator. The tuned circuit formed by inductor L2 and capacitor C4, load the oscillator to insure it will start when power is applied. RF noise is isolated from the supply line with the filter formed by capacitors C2, C3, and choke L1. The RF signal is coupled to "hot-carrier" diode D2, where it is modulated by the video signal.

COLOR GENERATOR

Transistor Q5 and its associated circuitry form a 3563.795 kHz color signal oscillator. Trimmer C9 adjusts the frequency, while control R17 adjusts the color level. Transistor Q4 serves as a supply voltage switch and is controlled by the video generator.

VIDEO GENERATOR

Integrated circuit IC101 is a complete dot-bar and color generation system. Crystal Y101 controls the internal oscillator that provides the various timing, synchronization, and video information required in the adjustment of color television receivers. Program switches SW101, SW102, SW103, and SW104 select the various video output signals. Two control signals are coupled to a switch formed by diodes D3, D4, D5, and D6, and transistor Q4. These two control signals switch the color generator and diode switch on and off as required.

The video signal is coupled through Video Level control R18 to diode D2, where it modulates the RF signal. When the Color Generator is turned on, its signal is mixed with the RF signal at D2. The modulated RF signal produced is then coupled through an impedance matching pad to the output cable.

CIRCUIT BOARD X-RAY VIEWS

NOTE: To find the PART NUMBER of a component for the purpose of ordering a replacement part:

- A. Find the circuit component number (R5, C3, etc.) on the X-Ray View.
- B. Locate this same number in the "Circuit Component Number" column of the "Parts List."
- C. Adjacent to the circuit component number, you will find the PART NUMBER and DESCRIPTION which must be supplied when you order a replacement part.

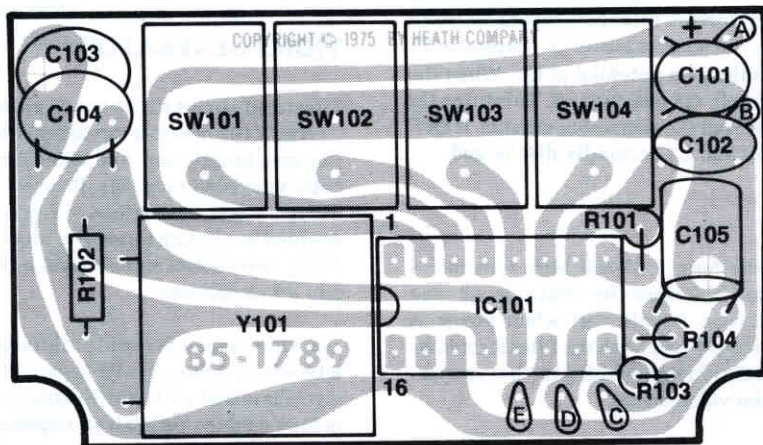

**VIDEO
CIRCUIT BOARD
(Viewed From Foil Side.)**

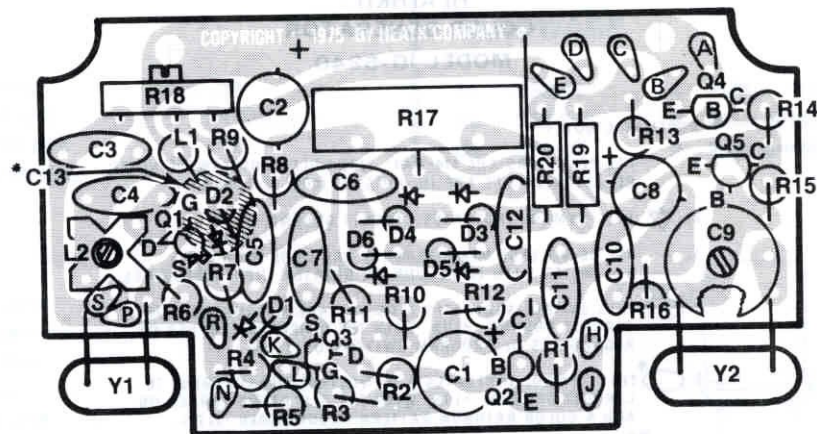







**RF OSCILLATOR
CIRCUIT BOARD**
(Viewed From Foil Side.)

*This component is mounted on the foil side.

**SCHEMATIC OF THE
HEATHKIT®
COLOR GENERATOR
MODEL IG-5240**

SCHEMATIC NOTES:

1. ALL RESISTORS ARE 1/4-WATT, 10% UNLESS OTHERWISE NOTED. RESISTOR VALUES ARE IN OHMS (K=1000, M=1,000,000).
2.  THIS SYMBOL INDICATES CIRCUIT GROUND.
3. ALL DC VOLTAGE MEASUREMENTS ARE MADE WITH A DC VOLTMETER WITH 10 MEGOHM OR GREATER INPUT IMPEDENCE.
4.  THIS SYMBOL INDICATES A DC VOLTAGE MEASUREMENT TO CIRCUIT GROUND, $\pm 10\%$, WITH THE GENERATOR TURNED ON, REGARDLESS OF PROGRAM SWITCH POSITION.
5.  THIS SYMBOL INDICATES A DC VOLTAGE MEASUREMENT TO CIRCUIT GROUND, $\pm 10\%$, WITH THE GENERATOR TURNED ON AND A COLOR RAINBOW PATTERN PROGRAMMED (1111).
6.  THIS SYMBOL INDICATES A DC VOLTAGE MEASUREMENT TO CIRCUIT GROUND, $\pm 10\%$, WITH THE GENERATOR TURNED ON, AND A CROSSHATCH PATTERN PROGRAMMED (1101).
7.  THIS SYMBOL INDICATES THE DC VOLTAGE WILL DECREASE WITH GENERATOR ON - TIME.
8.  THIS SYMBOL INDICATES A CIRCUIT BOARD WIRE CONNECTION.
9.  ARROW INDICATES COUNTERCLOCKWISE CONTROL ROTATION.

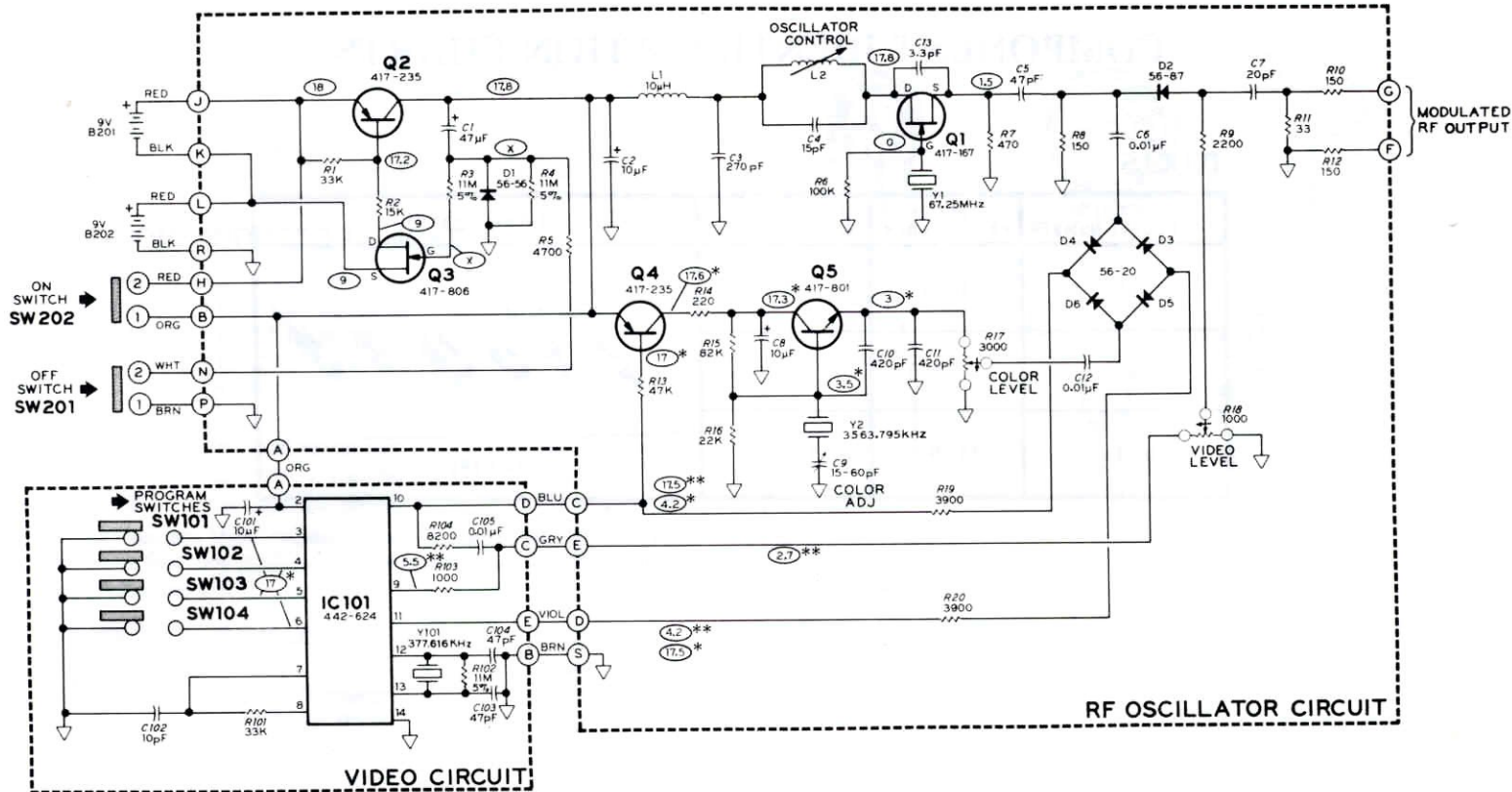

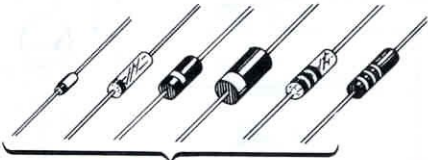

COMPONENT IDENTIFICATION CHARTS

DIODES

CIRCUIT COMPONENT NUMBER	HEATH PART NUMBER	MAY BE REPLACED WITH	IDENTIFICATION
D1	56-56	1N4149	 <p>BANDED END</p>
D2	56-87	FH1100	
D3-D6	56-20	1N295	

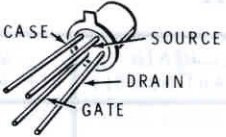
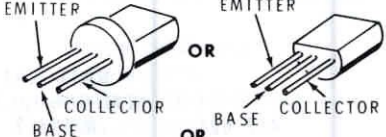
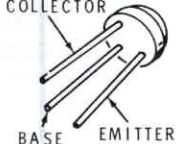
TRANSISTORS

CIRCUIT COMPONENT NUMBER	HEATH PART NUMBER	MAY BE REPLACED WITH	BASING DIAGRAM
Q1	417-167	HEATH PART NUMBER	
Q2, Q4	417-235	2N4121	
Q5	417-801	MPSA20	
Q3	417-806	T1S75	

INTEGRATED CIRCUIT

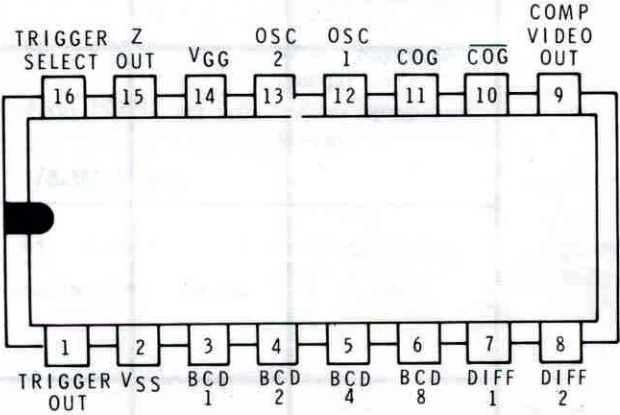
CIRCUIT COMPONENT NUMBER	HEATH PART NUMBER	MAY BE REPLACED WITH	BASING DIAGRAM
IC101	442-624	NATIONAL SEMICONDUCTOR MM5322	

CUSTOMER SERVICE

REPLACEMENT PARTS

Please provide complete information when you request replacements from either the factory or Heath Electronic Centers. Be certain to include the **HEATH** part number exactly as it appears in the parts list.

Replacement parts are maintained specifically to repair Heath products. Parts sales for other reasons will be declined.

ORDERING FROM THE FACTORY

Print all of the information requested on the parts order form furnished with this product and mail it to Heath. For telephone orders (parts only) dial 616 982-3571. If you are unable to locate an order form, write us a letter or card including:

- Heath part number.
- Model number.
- Date of purchase.
- Location purchased or invoice number.
- Nature of the defect.
- Your payment or authorization for COD shipment of parts not covered by warranty.

Mail letters to: Heath Company
Benton Harbor
MI 49022
Attn: Parts Replacement

Retain original parts until you receive replacements. Parts that should be returned to the factory will be listed on your packing slip.

OBTAINING REPLACEMENTS FROM HEATH ELECTRONIC CENTERS

For your convenience, "over the counter" replacement parts are available from the Heath Electronic Centers listed in your catalog. Be sure to bring in the original part and purchase invoice when you request a warranty replacement from a Heath Electronic Center.

TECHNICAL CONSULTATION

Need help with your kit? — Self-Service? — Construction? — Operation? — Call or write for assistance. You'll find our Technical Consultants eager to help with just about any technical problem except "customizing" for unique applications.

The effectiveness of our consultation service depends on the information you furnish. Be sure to tell us:

- The Model number and Series number from the blue and white label.
- The date of purchase.
- An exact description of the difficulty.
- Everything you have done in attempting to correct the problem.

Also include switch positions, connections to other units, operating procedures, voltage readings, and any other information you think might be helpful.

Please do not send parts for testing, unless this is specifically requested by our Consultants.

Hints: Telephone traffic is lightest at midweek — please be sure your Manual and notes are on hand when you call.

Heathkit Electronic Center facilities are also available for telephone or "walk-in" personal assistance.

REPAIR SERVICE

Service facilities are available, if they are needed, to repair your completed kit. (Kits that have been modified, soldered with paste flux or acid core solder, cannot be accepted for repair.)

If it is convenient, personally deliver your kit to a Heathkit Electronic Center. For warranty parts replacement, supply a copy of the invoice or sales slip.

If you prefer to ship your kit to the factory, attach a letter containing the following information directly to the unit:

- Your name and address.
- Date of purchase and invoice number.
- Copies of all correspondence relevant to the service of the kit.
- A brief description of the difficulty.
- Authorization to return your kit COD for the service and shipping charges. (This will reduce the possibility of delay.)

Check the equipment to see that all screws and parts are secured. (Do not include any wooden cabinets or color television picture tubes, as these are easily damaged in shipment. Do not include the kit Manual.) Place the equipment in a strong carton with at least **THREE INCHES** of resilient packing material (shredded paper, excelsior, etc.) on all sides. Use additional packing material where there are protrusions (control sticks, large knobs, etc.). If the unit weighs over 15 lbs., place this carton in another one with 3/4" of packing material between the two.

Seal the carton with reinforced gummed tape, tie it with a strong cord, and mark it "Fragile" on at least two sides. Remember, the carrier will not accept liability for shipping damage if the unit is insufficiently packed. Ship by prepaid express, United Parcel Service, or insured Parcel Post to:

Heath Company
Service Department
Benton Harbor, Michigan 49022



HEATH COMPANY • BENTON HARBOR, MICHIGAN
THE WORLD'S FINEST ELECTRONIC EQUIPMENT IN KIT FORM

LITHO IN U.S.A.