

INSTRUCTION MANUAL

Model: 72-720

**20MHz Dual Trace
Oscilloscope**

TENMA™

TABLE OF CONTENTS

SECTION 1	INTRODUCTION	Page 1
SECTION 2	SPECIFICATION	1
SECTION 3	OPERATION	
3-1	INITIAL OPERATION	2
3-2	CONTROLS & INDICATION	3
3-3	TRIGGERING	5
3-4	X-Y OPERATION	6
3-5	CALIBRATED VOLTAGE MEASUREMENTS	6
3-6	DUAL TRACE WAVEFORM OBSERVATION	6
3-7	TV SIGNAL SYNCHRONIZATION	6
3-8	ADD & SUB MEASUREMENTS	7
3-9	APPLICATIONS	7
3-9(1)	AC Voltage and Frequency Measurement	7
3-9(2)	DC Voltage Measurement	8
3-9(3)	AM Modulation Measurement	8
3-9(4)	Dual-Trace Application	8
3-9(5)	Level Comparison	8
3-9(6)	Repairing Stereo Systems	8
3-9(7)	TV Servicing	8
3-9(8)	Composite Video Analysis	9
3-9(9)	Measurement of Frequency by X-Y	9
3-9(10)	Phase Measurement	9
3-9(11)	Photograph	9
3-9(12)	Component Test	10
SECTION 4	CIRCUIT DESCRIPTION	
4-1	OUTLINES OF CIRCUIT	11
4-2	VERTICAL AMPLIFIER CIRCUIT	11
4-3	HORIZONTAL/TIME BASE CIRCUIT	13
SECTION 5	MAINTENANCE & ADJUSTMENTS	
5-1	GENERAL	14
5-1(1)	Preventive Maintenance	14
5-1(2)	Cleaning	14
5-1(3)	Recalibration	14
5-2	ADJUSTMENT AND CALIBRATION	14
5-2(1)	PRELIMINARY PROCEDURE	14
5-2(2)	POWER SUPPLY UNIT ADJUSTMENTS	14
5-2(3)	VERTICAL AMPLIFIER UNIT ADJUSTMENTS	16
5-2(4)	Horizontal/Time Base Unit Adjustments	18
SECTION 6	PARTS LIST	
6-1	CHASSIS	19
6-2	VERTICAL AMPLIFIER UNIT	20
6-3	TIME BASE UNIT	21
6-4	POWER SUPPLY UNIT	22
SECTION 7	SERVICING	
7-1	VERTICAL AMPLIFIER UNIT	24
7-1(1)	Vertical Amplifier Circuit Diagram	25
7-2	HORIZONTAL/TIME BASE UNIT	26
7-2(1)	Horizontal/Time Base Circuit Diagram	27
7-3	POWER SUPPLY CIRCUIT DIAGRAM	28
7-3(1)	Power Supply Unit	29

This model is a dual trace 20MHz oscilloscope using high brightness CRT.

The vertical amplifiers have high sensitivity of 5mV/DIV and the frequency characteristic response with the smooth rolloff exceeding 20MHz. The highest triggering sweep speed is 0.2 μ sec/DIV.

FEATURES

- 1) Component Tester
- 2) Wide bandwidth & high sensitivity
- 3) Very low power consumption
- 4) High sensitivity X-Y mode
- 5) Z axis (intensity modulation)
- 6) TV VIDEO SYNC Filter
- 7) High frequency rejection filter in the trigger circuit
- 8) Front panel electrical trace rotator
- 9) Regulated power supply circuit for accuracy

COMPONENT TESTER is the special circuit with which a single component or components in or out of actual circuit board can be easily tested requiring no power to drive the circuit.

The display shows FAULTS of components, size of a component value, and characteristics of components, and half-dead components under a dynamic test.

SECTION 2

SPECIFICATIONS

VERTICAL DEFLECTION

Deflection Factor	5mV to 20V/DIV on 12 ranges in 1-2-5 step with fine control.
Bandwidth	DC to 20MHz(-3dB) AC: 10Hz to 20MHz(-3dB)
Risetime	Less than 17.5nsec
Overshoot	Less than 3%
Input Impedance	1M Ω shunted by 20pF \pm 3pF(Max input: 600Vp-p or 300V DC + AC peak)
Operating Modes	CH-A, CH-B, DUAL and ADD
Chop Frequency	200kHz approx.
Channel Separation	Better than 60dB at 1kHz
CH-B Polarity	CH-B can be inverted

TIME BASE

Type	Automatic and triggered. In automatic mode, sweep is obtained without input signal.
Sweep Time	0.2 μ sec to 0.5sec/DIV on 20 ranges in 1-2-5 step with fine control and X-Y
Magnifier	X5 at all ranges
Linearity	Less than 3%

TRIGGERING

Sensitivity	INT: 1 DIV or more EXT: 1 Vp-p or more
Source	INT, CH-B, LINE or EXT
Triggering Level	Positive and Negative, continuously variable level control Pull for AUTO
Range	20Hz to 20MHz or more
Sync	AC, HF Rej, TV(each + or -) At TV Sync TV-H(Line) and TV-V(Frame) sync are switched automatically by SWEEP TIME/DIV switch. TV-V: 0.5sec/DIV to 0.1msec/DIV TV-H: 50 μ sec/DIV to 0.2 μ sec/DIV

HORIZONTAL DEFLECTION

Deflection Factor	5mV to 20 V/DIV on 12 ranges in 1-2-5 step with fine control.
Frequency Response	DC to 1MHz(-3dB)
Input Impedance	1M Ω shunted by 20pF \pm 3pF
Max Input Voltage	300V DC + AC peak or 600Vp-p
X-Y Operation	X-Y mode is selected by SWEEP TIME/DIV switch CH-A: Y axis CH-B: X axis
Intensity Modulation	Z Axis: TTL Level (3Vp-p \sim 50V) + bright, - dark.

OTHER SPECIFICATIONS

CRT HV	APPROX-2K V
Calibration Voltage	0.5Vp-p \pm 5%, 1 kHz Square Wave
Power Requirements	AC: 100V/120V/220V/240V/, 50/60Hz, 19W
Weight	7kg approx.
Dimensions	162(H) X 294(W) X 352(D)mm

SECTION 3

OPERATION

3-1 INITIAL OPERATION

Inspect the carton for serious damage which might have caused failure of the instrument during transportation. If damage is noted, notify the agent you bought from before turning on.

INITIAL AC OPERATION

- Prior to any kind of operation of the instrument, proceed as follows to get familiarized with the instrument.
 - Set the POWER switch to OFF.
 - Turn all the three POSITION controls to mid-position.
 - Turn INTENSITY control to mid-position.
 - Push the PULL 5X MAG control for normal.
 - Pull TRIGGERING LEVEL control for AUTO.
 - The rest of the controls remain at any position for normal operation.
 - Check the line voltage.
- Connect the AC line cable into the AC receptacle on the rear panel of the instrument, and plug into an AC power outlet.
- Turn POWER to ON. After approximately 20 seconds, trace lines appear on CRT screen. If no trace lines appear, rotate INTENSITY clockwise till trace lines are easily observed.
- Adjust FOCUS and INTENSITY controls for clear trace lines.
- Readjust Vertical and Horizontal POSITION controls for locations required.
- Connect a probe (10:1) to INPUT of CH-A and hook the tip of the probe to CAL 0.5Vp-p output.
- Rotate CH-A Vertical attenuator VOLTS/DIV switch to 10mV/DIV and turn the VARIABLE on the same axis clockwise to detent. Turn TRIGGERING SOURCE to CH-A. Then a square-wave of 5 divisions is displayed on the screen.
- If the square-wave is distorted, adjust the trimmer of the probe till it becomes a good square-wave.
- Remove the probe tip from CAL 0.5Vp-p output. Now, the oscilloscope is ready for use.

3-2 CONTROLS & INDICATIONS

1. VERTICAL INPUT

Vertical input terminal for CH-A.

2. AC-GND-DC

Vertical input coupling for CH-A. In AC position, the DC component of input signal is blocked by a capacitor. In GND position, the input terminal opens and the input of the internal amplifier is grounded. In DC position, the input terminal is directly connected to the amplifier and all components of input signal are displayed.

3. MODE

CH-A: Waveforms of CH-A are displayed.

CH-B: Waveforms of CH-B are displayed.

DUAL: In the range from 0.5sec/DIV up to 1 msec/DIV, both channels are chopped at about 200kHz.

In the range from 0.5 msec/DIV up to 0.2 μ sec/DIV, both channels are switched alternately.

ADD: CH-A and CH-B signals are added. By pulling $\text{\textcircled{23}}$ PULL INVERT, SUB mode is obtained.

4. VOLTS/DIV VARIABLE for CH-A.

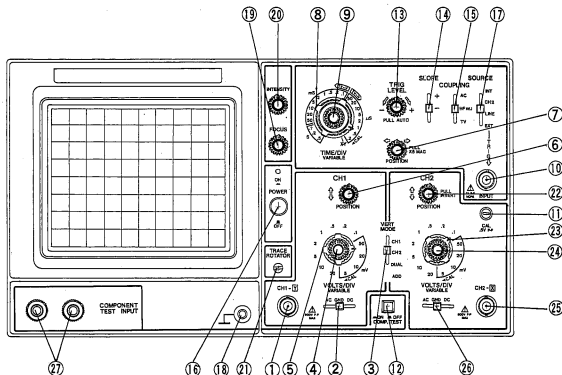

Fig. 1

5. VOLTS/DIV

Vertical attenuator for CH-A. The scale is graduated in voltage per "DIV" of CRT screen area.

Calibrated voltage is indicated when the VARIABLE is turned fully clockwise.

Selectable in 10 calibrated ranges from 5 mV/DIV to 20V/DIV.

6. VERTICAL POSITION

Vertical position adjuster for CH-A.

7. HORIZONTAL POSITION and PULL 5X MAG

Horizontal position adjuster. When pulled, SWEEP TIME is magnified by 5.

8. SWEEP TIME/DIV

Horizontal sweep time selector. It selects sweep times of $0.2\mu\text{sec}/\text{DIV}$ to $0.5\text{sec}/\text{DIV}$ in 20 calibrated steps. X-Y operation is possible by turning the knob fully clockwise to CH-B.

Change over between CHOP and ALTERNATE is also accomplished automatically by this selector in DUAL MODE

9. SWEEP TIME/DIV VARIABLE

10. EXT. TRIG

Input for external triggering signal.

11. CAL

Calibration voltage terminal. Calibration voltage is 0.5Vp-p of about 1 kHz square wave.

12. COMP. TEST

Switch to change from oscilloscope to component tester.

For component testing (8) SWEEP TIME/DIV must be set to CH-B

for X-Y mode and also both (2)-(7) AC-GND-DC switches to GND positions.

13. TRIGGERING LEVEL

LEVEL control adjusts sync phase to determine the starting point of sweep on the slope of displayed waveform.

PULL AUTO

By pulling LEVEL knob toward you, auto-sweep is effected; the sweep is set in free-running state even when no input signal is applied, with trace line displayed on CRT.

With trigger signal, triggered-sweep is effected where sync level is adjustable. When sync level is deviated, the sweep is set in free-running state.

14. SLOPE +, -

Sync slope polarity is selected.

15. SYNC

Sync mode selector switch.

AC: For normal operation. In this mode sync signal is directly fed to the sync circuit.

HF REJ: Low Pass Filter cuts off RF, composite of the sync signal.

TV: TV or Video composite signals are easily triggered.

SWEEP TIME/DIV selects TV-V ($50\mu\text{sec}\sim 0.1\text{ msec}$) or TV-H ($50\mu\text{sec}\sim 0.2\mu\text{sec}$)

16. GND

Ground terminal.

17. SOURCE

Sync signal selector.

INT: CH-A and CH-B signals are added on for triggering.

CH-A: Sync signal for triggering comes only from CH-A. But, when in single sweep, the channel selected by MODE has priority.

CH-B: Signal from CH-B. The rest is the same as CH-A.

LINE: AC power line waveform is used as sync signal source.

EXT: The signal hooked into EXT TRIG becomes the sync signal source.

18. POWER SWITCH

On or off.

19. FOCUS

Focus control to obtain optimum waveform display.

20. INTENSITY

Adjust the brightness of waveform for easy viewing.

21. TRACE ROTATOR

The earth magnetic effect the trace line. Rotate this with a screw driver for proper trace line.

22. CH-B POSITION, PULL INVERT

CH-B vertical position control. When pulled, the CH-B vertical polarity is inverted. This facilitates SUB MODE measurement at ADD MODE.

23. VOLTS/DIV

Vertical attenuator for CH-B.

24. VARIABLE

25. VERTICAL INPUT

Vertical input for CH-B.

26. AC-GND-DC

For CH-B, same as ②.

27. COMPONENT TEST IN.

Terminals to connect a component or lead wires to a component under test.

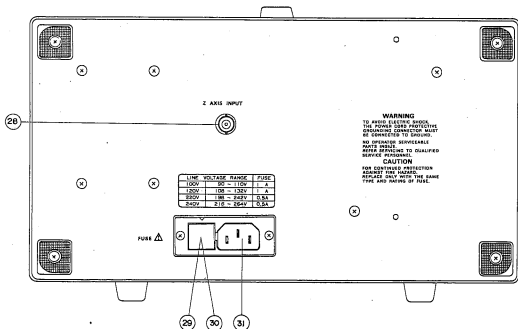

28. Z AXIS

External Intensity Modulation Input.

29. FUSE HOLDER

Proper ampere fuse must be in compartment

30. VOLTAGE SELECTOR

Proper line voltage must be selected where this oscilloscope is used.

31. RECEPTACLE for AC line cable.

3-3 TRIGGERING

Generally, triggered oscilloscopes have the following circuits to display stable waveform on the screen.

Vertical input signal or integral number related signal is used for a sync pulse signal, which is used as a triggering signal. This signal stabilizes the waveform display. However, this triggering must be exactly synchronized to the vertical input signal. And all the knobs should be correctly used.

This model has 4 knobs to control triggering. They are LEVEL, SLOPE, SYNC and SOURCE.

(SOURCES)

When the vertical input signal is supplied to the internal SYNC circuit, it is called INTERNAL TRIGGER.

When the same signal or integral number related signal is applied into the SYNC circuit through EXT TRIG input, it is referred as EXTERNAL TRIGGER. In this model INT, CH-A and CH-B of SOURCE switch are internal triggers.

The internal trigger signal is amplified in the vertical amplifier and triggering becomes easy.

LINE: The AC power line waveform is supplied to the SYNC circuit as a triggering source.

EXT: When SOURCE is turned to EXT, it becomes external trigger which has namely 3 benefits.

1. Triggering signal receives no effects from the vertical circuits.
EX. Triggering level need be readjusted when VOLTS/DIV knobs are turned because the sync source voltage changes. In such case, unless the external trig input voltage is changed, triggering is very stable and free from vertical controls.
2. Input signal can be easily delayed by the use of the delaying function of a pulse generator.
3. Composite signal or modulated signal can be easily triggered by the signal which composes the composite signal.

(SYNC)

This switch has a selection of the sync circuit coupling. At AC position it becomes AC coupling and DC composite is isolated for stabilized synchronization. HF REJ has a low pass filter to eliminate RF noise interference to synchronization.

At TV position either vertical or horizontal sync signal isolation circuit works to ensure the TV signal triggering.

Selection of TV-V or TV-H is done by SWEEP TIME/DIV switch.

(SLOPE)

SLOPE switch +, - selects the triggering source signal slope of positive or negative.

At TV sync, triggering point is set to sync pulse rising time or falling time.

(LEVEL)

When this knob is pulled, it becomes AUTO for free running without the input signal for 0 level reference. When a signal is applied to the input, turn this knob for stable triggering.

3-4 X-Y OPERATION

For some special cases, this instrument is specially designed for easy X-Y application. Simply turn SWEEP TIME/DIV switch to CH-B. Then all CH-B functions work as horizontal amplifier, whereas CH-A remains as vertical amplifier.

3-5 CALIBRATED VOLTAGE MEASUREMENTS

Peak voltages, peak-to-peak voltages, DC voltages and voltages of a specific portion of a complex waveform can be measured using this instrument as a voltmeter. Voltages can be measured whenever waveforms are observed using either CH-A or CH-B inputs. Proceed as follows:

1. Set VARIABLE control fully clockwise to CAL position, then set VOLTS/DIV control to display the waveform in proper size to be observed. Vertical POSITION controls may be turned to obtain division reference.
2. For DC or complex signals, set the input switch to GND, and adjust the vertical POSITION control to a convenient reference level. Set the switch to DC and observe the amount of deflection. A positive voltage will deflect trace upwards; a negative voltage will deflect the trace downward. To calculate the voltage reading, multiply the vertical deflection (by division) by the setting of the VOLTS/DIV switch.

NOTE WHEN A PROBE (10:1) IS USED, THE WAVEFORM DISPLAY IS ONLY 1/10 OF THE ACTUAL VOLTAGE MEASURED.

3-6 DUAL TRACE WAVEFORM OBSERVATION

MODE switch to be turned to DUAL. Other procedures are in the same manner as mentioned above.

3-7 TV SIGNAL SYNCHRONIZATION

Set TRIGGERING SYNC to TV (+ or -), then specially designed circuitry provides easy triggering for complexed TV frame and line signal. TV frame and line waveform are easily obtained by simply tuning SWEEP TIME/DIV control.

3-8 ADD & SUB MEASUREMENTS

Simply turn MODE switch to ADD, added waveform of CH-A and CH-B is displayed.

With this MODE at ADD position, subtracted waveform is obtained by pulling INVERT knob which inverts the polarity of CH-B.

3-9 APPLICATIONS

This is a dual trace oscilloscope which has full capability of single trace mode. Thanks to the dual-trace functions, various effective measurements are feasible.

[SINGLE-TRACE APPLICATIONS]

Either Channel A or Channel B can be used for single-trace operation. Channel A is referred to hereunder for simplicity.

Set controls:

AC-GND-DC	AC
MODE	CH-A
SYNC	NORM +
SOURCE	INT
PROBE	to CH-A INPUT Jack

Connect the tip of the probe to the point in the circuit where the wave form is to be measured, and its ground clip to the chassis or the ground part.

CAUTION !!! THE PEAK-TO-PEAK VOLTAGE AT THE POINT OF MEASUREMENT SHOULD NOT EXCEED 600 VOLTS.

3-9(1) AC VOLTAGE AND FREQUENCY MEASUREMENT

When measuring voltage and frequency, set VOLTS/DIV VARIABLEs ④, ⑤ and SWEEP TIME/DIV VARIABLE ⑨ at their calibrated detent points (clockwise).

(EX) The signal displayed on the CRT is

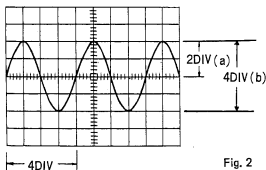

VOLT/DIV at 2V
SWEEP TIME/DIV at 5 msec.

Fig. 2

- (a) Peak voltage $2V/DIV \times 2DIV = 4$ volts
 (b) p-p voltage $2V/DIV \times 4DIV = 8$ volts
 (c) Effective voltage Peak voltage $\div \sqrt{2} = 2V \times 2DIV \times \frac{1}{\sqrt{2}}$
 $= 2.828$ volts
 (d) Frequency (Hz) $1/Time$ (second)

** Time = Number of DIVs for 1 cycle \times
value of SWEEP TIME/DIV

Therefore, the Fig 2 waveform is:

$$Frequency = \frac{1}{5m \text{ sec} \times 4 (DIV)} = \frac{1}{20m \text{ sec}}$$

$$= 50\text{Hz}$$

NOTE !!!

The input of this oscilloscope is $1M\Omega$ shunted by $20pF$ capacitance. When the probe is used in 10:1 attenuation, the impedance becomes $10M\Omega$ shunted by $15pF$. Then the voltage reading must be multiplied by 10.

3-9-(2) DC VOLTAGE MEASUREMENT

AC-GND-DC being at AC position, only AC or AC component was displayed on the CRT screen. For DC Measurement, set the switch to GND and pull the TRIGGERING LEVEL knob (13) for a trace line, which must be positioned at a certain place as 0 volt reference.

After that, turn the switch to DC. Then the trace line shifts up or down. The value of movement is the DC voltage.

$$\text{DC voltage} = \text{Shift (DIV)} \times \text{VOLTS/DIV}$$

When the trace line shifts up-ward, the polarity is (+), and down-ward is (-).

3-9-(3) AM MODULATION MEASUREMENT

There are various ways of measurements, but herein this manual the envelope method is introduced. This method is applicable when the carrier frequency is within the frequency bandwidth of the oscilloscope. See Fig. 3.

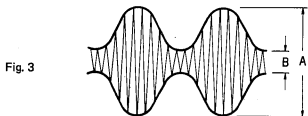

Fig. 3

$$\text{Mod. (\%)} = \frac{A - B}{A + B} \times 100$$

3-9-(4) DUAL-TRACE APPLICATIONS

MODE switch being turned to DUAL, both Channel A and Channel B works simultaneously.

Then, comparison of two relative signals are easily done such as level, waveforms, phase, etc.

3-9-(5) LEVEL COMPARISON

(EX) OUTPUT/INPUT of an amplifier

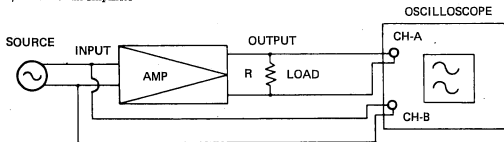

Fig. 4

With the connections of the Fig. 4 set the displays of CH-A and CH-B the same (POSITION controls be adjusted to place CH-B waveform onto CH-A). Then the difference between displays of CH-A VOLTS/DIV and CH-B's is the gain of the amplifier. If the two signals do not match each other even when variable controls are adjusted, the difference is the distortion caused in the amplifier. Then, simply turn the MODE switch to ADD and pull the CH-B position knob for invert (SUB MODE), for viewing only distortion. When there is no distortion originated in the amplifier, a straight trace line is displayed in SUB MODE.

3-9-(6) REPAIRING STEREO SYSTEMS

Every stereo equipment has two symmetrical amplifier circuits.

So, simultaneous comparison of the same stages makes it so easy to locate defective point.

3-9-(7) TV SERVICING

Triggered oscilloscope is indispensable. This model has the very convenient TV SYNC circuits of TV-V (Frame) and TV-TV-H (line) for accurate synchronization to view VIDEO SIGNAL, BLANKING PEDESTALS, VITS and Vertical/Horizontal SYNC PULSES.

3-9(8) COMPOSITE VIDEO ANALYSIS

The most important waveform in TV servicing is the composite signal consisting of the video signal, the blanking pedestals, and sync pulses. Fig. 5 and Fig. 6 show composite signals synchronized with horizontal sync pulses and vertical blanking pulses.

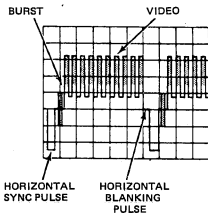

Fig. 5

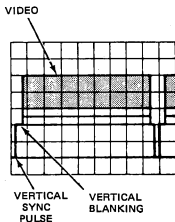

Fig. 6

3-9(9) MEASUREMENT OF FREQUENCY BY X-Y

Simply turn SWEEP/DIV switch to CH-B for X-Y operation. Then CH-A becomes Y axis and CH-B X axis. Connect a standard frequency signal to CH-B and unknown signal to CH-A. Lissajous figure is displayed on the screen as shown in Fig. 7.

Standard signal frequency: Unknown signal frequency



Fig. 7

3-9(10) PHASE MEASUREMENT

In X-Y function, apply two signals to each CH-A and CH-B. Calculate according to the formula.

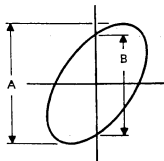

$$\text{SINE } \phi = \frac{B}{A}$$

ϕ = PHASE ANGLE

Fig. 8

3-9(11) PHOTOGRAPH

CRT CAMERA (using Polaroid film) exact hood size camera for this oscilloscope is available.

3-9-(12) COMPONENT TEST

Turn SWEEP TIME/DIV knob to CH-B (clockwise) for X-Y mode and set both AC-GND-DC switches to the GND position as well as setting the both VOLTS/DIV knob CH-A to 2V/DIV, CH-B to 5V/DIV, then push the COMP. TEST SW. Components may be directly hooked to the COMP. TEST IN terminals or through lead wires. Fig. 9 shows some reference displays.

Note: While in COMPONENT TEST operation, AC 9 VRMS is at the terminal for no load and about 2 mA will flow when they are shorted.

Fig. 9

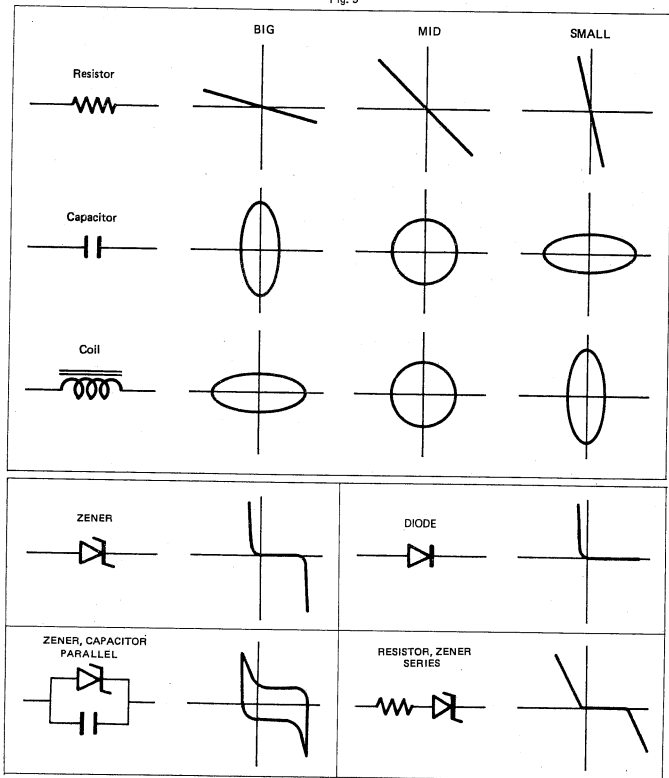

4-1 OUTLINES OF CIRCUIT

Block diagram of this model is as Fig. 10.

This oscilloscope is equipped with 2 identical input attenuators and preamplifiers. The input signal is attenuated to the required level, amplified to the preamplifier, and led to the trigger pick off circuit, then to the switching circuit.

At the trigger pick off circuit, a part of the signal is picked up and fed to the trigger select logic for either CH-B, INT (CH-A + CH-B) and led to the trigger amplifier of the TIME BASE Block.

The switching circuit consists of diode-gate and mode control logic to select CH-A, CH-B and DUAL.

After the switching circuit the signal is amplified, and goes through a cascade type final stage amplifier for CRT vertical deflector.

The trigger signal or an external trigger signal is amplified and reformed as a clock pulse to drive the following saw tooth generator circuit, which consists of JKRS flip-flops and sweep controller, FET input Miller integrator, hold-off.

The tooth wave generated by the clock pulse, is led to a differential amplifier which, is equipped with a stabilized current supply, then fed to CRT horizontal deflector.

For X-Y operation, CH-B input signal is led to the pick-off circuit, sweep X-Y selector, then horizontal final amplifier.

Q signal in the sweep control flip-flop and NAND of chopper rising edges are used for unblanking and chop-blanking. It is led to a cascade amplifier with a constant current load, a DC producing circuit and then added on to a high voltage, and then fed between the control grid and cathode of the CRT. The CRT is cut off during trace fly-back, and while waiting for trigger and chop change over time.

The power supplies are all regulated.

A feedback type DC-DC converter is used for generating the stabilized high voltage to CRT.

4-2 VERTICAL AMPLIFIER CIRCUIT

The vertical input signal fed from the BNC input terminal is controlled by the AC-GND-DC switch and applied to the 1st attenuator, where 1/10 step (20dB) attenuation takes place. The out of input protection circuit Q1 (Q25) is fed to the DUAL FET through high input impedance. DUAL FET is well DC balanced against temperature variation. The output is then applied to the 2nd attenuator composed of 1C1 (1C2). The 2nd attenuator makes the selection of 1/1, 1/2, 1/4 steps, modifying gain of 1C1 (1C2). After being DC balanced, through VR1, 3, 4 (VR7, 9, 10), the output signal is fed to the diode switching circuit composed of D2-5, 16-19 as well as to the trigger amplifier made of Q7, 8, 31, 32.

The mode logic circuit which is controlled by the MODE switch, makes the selection of dual-trace, single-trace, CHOP and ALT possible. Dual-trace operation is obtained by the trigger select logic circuit driven by TRIG SOURCE switch, while the vertical MODE switch works prior to TRIG SOURCE switch and selects a proper trigger signal for single-trace operation.

In single trace operation triggering is automatically logic controlled according to the vertical MODE switch prior to Trigger SOURCE Selector.

In X-Y operation, controlled by the SWEEP TIME/DIV control, CH-B signal is supplied to the trigger amplifier and fed to the horizontal amplifier as the X signal.

The vertical signal through diode switching circuit passes the limiter circuit of Q11, 12 and D6-9 to obtain the adequate level, and then is fed to the output amplifier composed of Q15-24. The output obtained is sufficiently amplified by the feedback-type amplifier with the constant current circuit (Q19, 20, 23, 24). This amplifier is equipped with the booster (Q21, 22) for high frequency contents to obtain flat response signals. The signal is then fed to the vertical deflection plates of CRT.

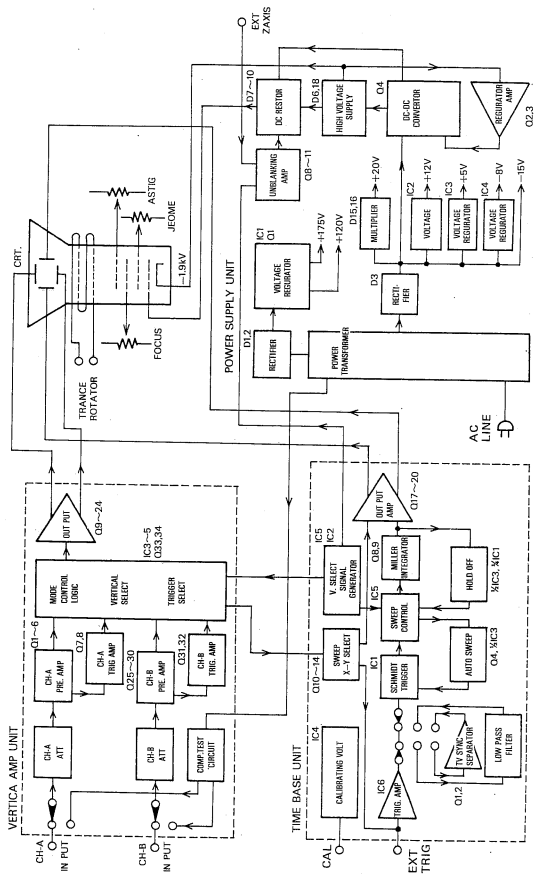

Fig. 10

4-3 HORIZONTAL/TIME BASE CIRCUIT

Time Base circuit consists of trigger section, the saw-tooth section and amplifier section. The output from trigger select circuit is led to sweep X-Y select circuit (Q11~14). This select circuit works as the internal trigger amplifier and the saw-tooth wave amplifier in normal operation, and as the amplifier for CH-B signal in X-Y operation. The internal trigger signal is being amplified by 1C6 and then fed to schmidt circuit (1/2 IC1). The external trigger signal is directly fed to IC6. With TRIG SOURCE switch set to HF REJ, noises and high frequency components in the trigger source are eliminated. With TRIG SOURCE switch set to TV, IC output is connected to TV sync separator (Q1,2) to obtain horizontal sync signal (TVH) or vertical sync signal (TVV) and to supply it to schmidt circuit. Changeover between TVH and TVV is automatically accomplished by the SWEEP TIME/DIV switch. The signal in the schmidt trigger circuit is shaped into square waves and becomes clock pulses for sweep control gate (IC5). The clock pulse is also supplied to auto sweep (Q4, 1/2 IC3). With no trigger input, the output of the auto sweep circuit becomes low level, and therefore sweep control gate starts automatic sweeping. With triggering input, or supply of clock pulse, the output of auto sweep circuit becomes high level and the gate F.F. is inverted by the clock pulses and the Miller integrator becomes charged. Also, the output of auto-circuit actuates Q23 ON/OFF. When the gate F.F. is inverted, and sets Q7 to OFF, the Miller integrator determines the sweep time by the C/R time constant selected by the SWEEP TIME/DIV switch to obtain saw-tooth waves of excellent linearity. When the output from the Miller integrator fully rises, the Hold-off F.F. is inverted and the sweep stops for the time determined by the Hold-off time constant. When the Hold-off time passes, the next clock pulse is set in standby mode and thereby the sweep returns to the original status.

The output of this Miller integrator passes through sweep X-Y select circuit and is fed to the horizontal amplifier (Q17~20). In this amplifier, by use MAG X5 switch, sweep time is expanded by factor of 5. With SWEEP TIME/DIV switch set to X-Y position, sweep X-Y select circuit is switched to separate the Miller integrator from the horizontal amplifier and then the vertical CH-B input is applied as horizontal input amplifier. In CHOP operation, blanking effects are given with the use of the horizontal Q output and CHOP signal generator. In ALT operation, the effects are given by Q output.

The output from multivibrator of IC4 is shaped to obtain the calibrating voltage output. The variable resistor of VR5 is used to adjust the output level of 0.5p-p.

5-1 GENERAL

This section contains information for preventive maintenance, adjustment and calibration.

5-1(1) PREVENTIVE MAINTENANCE

Preventive maintenance consists of periodic cleaning, and recalibration of the oscilloscope. It should be performed on a regular bases to keep the instrument in its best operational and appearance condition.

5-1(2) CLEANING

Accumulation of dirt, dust and grime should be removed whenever they become noticeable. The frequency of cleaning is largely dependent upon the environment in which the instrument is used. Dirt on the outside covers may be removed with a soft cloth moistened with a diluted household cleaning solution.

5-1(3) RECALIBRATION

Recalibration of the instrument at regular intervals will assure that measurements within the accuracy specification. It is recommended that the instrument be recalibrated after 1000 hours of operation, or twice a year. The calibration procedures are provided in the latter part of this section of the manual.

5-2 ADJUSTMENT AND CALIBRATION

Most of the problems resulting in a malfunction will be a defective component or a mechanical defect. Verify that the problem is not due to an incorrect switch position. The CRT display can be a valuable aid in pinpointing the area of many problems. The defect of any of the amplifiers, triggering circuit will be noticeable on the CRT.

Test Instruments Required

Instrument	Brief Specification
1. Digital Voltmeter	Range : 0 to 1000V DC Accuracy : Within 0.5%
2. 10 : 1 High Voltage Divider	± 2%
3. Square wave generator	1KHz ~ 1MHz, Resetime < 5nS
4. Oscillator	1KHz ~ over 20MHz
5. Time Mark Generator	Pulse ranges from 0.1 μ s to 0.5mS ± 1%
6. Cable	Male BNC to male BNC, 50 Ω

5-2-1 PRELIMINARY PROCEDURE

- check that the 100V/117V/220V/240V/ and Voltage selector is properly set.
- turn the instrument on and allow at least 20 minutes warm-up before starting the adjustment procedure.

For the best overall accuracy, make adjustments in ambient temperature of +20°C to +30°C.

5-2-2 POWER SUPPLY UNIT ADJUSTMENTS

Some problems may result severe loading on the power supplies. The power supply unit for this model comprises a DC to DC converter. The normal operating frequency of the converter is approximately 40KHz. Modifying pulse width with the change of loads, this converter assures the constant voltage supply. When the secondary voltage of the converter is incorrect, remove the P4 and P7 connectors of the Power Supply unit for checking.

1. Voltage Adjustments

- Connect Digital Voltmeter common (or -) lead to the 5th pin on connector P4.(or ground)
- Connect Digital Voltmeter V. Ω (or +) lead to the 1st Pin on connector P4.
- Adjust VR6 until + 200V supply gives reading of +200V \pm 0.5V.

- d) Transfer Digital Voltmeter V. Ω (or +) lead to the 2nd pin on connector P7.
 - e) Adjust VR1 for Digital Voltmeter reading of $-1.9 \text{ KV} \pm 5\text{V}$.
 - f) Disconnect Digital Voltmeter.
2. Adjustments of intensity limit, Astigmatism, Trace Alignments.
 - a) Set Time/Div. switch to CH B position.
 - b) Center beam using Position (\uparrow).
 - c) Rotate Intensity to 10 o'clock position.
 - d) Adjust VR5 (intensity limit adjustment) so beam is just extinguished.
 - e) Adjust INTENSITY to obtain normal spot brightness and FOCUS to center position.
 - f) Adjust Astigmatism adjustment, VR3 and jeome adjustment, VR4 to get a sharp, round dot.
 - g) Set TIME/DIV. switch to $0.5\mu\text{s}$ position.
 - h) when fly-back line appears on the CRT with trace line, adjust VR2 until the fly-back line is minimized.
 - i) repeat step a to f
 - j) Adjust trace rotator so that trace is parallel with horizontal graticule lines. Local magnetic field affects this setting.

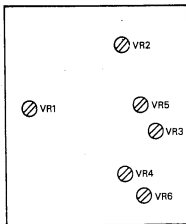

Fig. 12
POWER SUPPLY UNIT
290-1017-33

5.2.3 VERTICAL AMPLIFIER UNIT ADJUSTMENTS

1. Adjustments of preamplifier

- a) Preliminary control setting : preset front panel controls as follows:

Intensity	Midrange
Focus	Midrange
Vertical Mode	CH A
Volts/Div. (both)	10mV
AC-GND-DC (both)	GND
Variable	Detent
Time/Div.	0.5mS
Source	INT
SYNC	NORM +
Level	Midrange and pull auto
Position (All)	Midrange

- b) short TP terminal of V-PCB.

- c) Adjust VR6 so that sweep lines could be at the center of CRT.

- d) open TP terminal

- e) Use CH A Position (
- \ddagger
-) control to set trace on center horizontal graticule line.

- f) Adjust VR1 (VR7 for CH B) for no trace shift while switching CH A Volts/Div control between 2mV and 10mV.

- g) Adjust VR3 (VR9 for CH B) until no trace shift occurs when CH A Variable move between minimum and maximum.

- h) Rotate CH A Position (
- \ddagger
-) to 12 o'clock position and adjust VR4 (VR10 for CH B) so that sweep lines could be at the center of CRT.

- i) Repeat steps e) through h) for CH B.

2. Adjustments of attenuator

- a) Set CH A Volts/Div switch to 0.1V setting and Time/Div switch to 20
- μ
- s setting.

- b) Set vertical Mode switch to CH A

- c) Connect square-wave generator (600
- Ω
- output) to CH A input connector.

- d) Set square-wave generator control for 1 KHz output with sufficient amplitude to produce 6 divisions of vertical deflection.

- e) Adjust TC1 (TC7 for CH B) compensation adjustments to achieve squarest corners on the displayed waveform.

- f) Set square wave generator for 1KHz signal 6 divisions of vertical deflection.

- g) Adjust input capacitor adjustment TC2 (TC8 for CH B) for best possible waveform.

- h) Set Volts/Div switch to 1V settings. Adjust square wave generator output for 1 KHz and 6 divisions of vertical deflection.

- i) Adjust TC3 (TC9 for CH B) compensation adjustment to achieve squarest corners on displayed waveform.

- j) Set square wave generator controls for 1KHz output with sufficient amplitude to produce 6 divisions of vertical deflection.

- k) Adjust input capacitors TC4 (TC10 for CH B) for best possible wave form.

- l) Set Volts/Div switch to 10V settings. Adjust square wave generator output for 1 KHz and 6 divisions of vertical displays.

- m) Adjust TC5 (TC11 for CH B) compensation adjustment to achieve squarest corners on displayed waveform.

- n) Set square wave generator control for 1KHz output with sufficient amplitude to produce 6 division of verticle deflection.

- o) Adjust input capacitors TC6 (TC12 for CH B) for best possible waveform.

- p) Repeat steps a through O for CH B.

- q) Setting

SECTION 5

Volts/Div (both)	0.1V
CH A AC-GND-DC	DC
CH B AC-GND-DC	GND
Verticle Mode	CH A
Time/Div	1 μ S
Source	INT
SYNC	NORM +
Level	Midrange and Pull Auto

- r) Adjust square wave generator output for 100KHz and 6 division of verticle display.
 - s) Adjust TC13 until squarest waveform.
 - t) Adjust C11 (CH-A) and C50 (CH-B) until squarest waveform for over shoot and under shoot.
 - u) Adjust VR13 until no waveform distortion occurs when position (\ddagger) control between up and down.
3. Adjustment of Vertical gain

a) Setting

Volts/Div (both)	2mV
Vertical Mode	CH A
AC-GND-DC (both)	DC
Time/Div	0.5mS
Source	INT
SYNC	NORM +
Level	Midrange and Pull Auto

- b) Connect Oscillator to CH A input connector.
- c) Set Oscillator for 1KHz at exactly 10mV p-p Amplitude.
- d) Adjust Verticle gain adjustment VR5 (VR11 for CH B) for exactly 5 divisions of verticle deflection. This ensures 3% accuracy in the vertical amplifier.
- e) Set vertical Mode to CH B.
- f) Repeat steps b) through d) for CH B.
- g) Set Time/Div. switch to CH B position and CH B Volts/Div switch to 20mV setting. Center beam using position (\ddagger) controls.
- h) Connect Oscillator to CH B input connector and Set Oscillator for 1KHz at exactly 10mV P-P amplitude.
- i) Adjust VR 12 for exactly 5 divisions of horizontal deflection.
- j) Disconnect Oscillator.

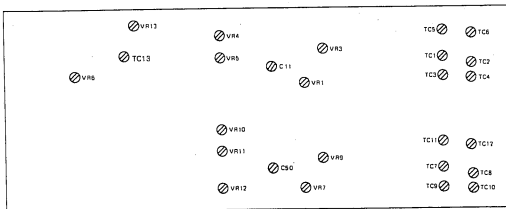

Fig. 13

VERTICAL AMPLIFIER UNIT
290-1016-34

5-2-4 Horizontal/Time Base Unit Adjustments.

1. Adjustment of Sweep Time/Div.

a) setting.

Volts/Div (both)	0.1mV
Vertical Mode	CH A
Time/Div	0.1mS
Source	INT
SYNC	NORM +
Level	Midrange and Pull Auto

- b) Connect Time marker generator to CH A input connector and set generator for 0.1mS marker interval.
- c) Adjust VR8 so that lie on vertical graticule lines.
- d) Set generator for 1 μ S marker interval and 620C sweep to 1 μ S.
- e) Adjust TC2 so that time marker again co-incide with vertical line of graticule.
- f) Set generator for a 0.5 μ S marker interval and Time/Div switch to 0.5 μ S settings.
- g) Adjust TC1 so that markers lie on Vertical graticule and adjust VR14 for realignment of the range of 0.2 μ S/Div.
- h) Set Time/Div switch to 0.1mS setting and set generator for a 0.1mS marker interval.
- i) Set 5 X MAG switch to pull.
- j) Adjust VR12 for exactly 5 divisions for horizontal deflection and then push MAG switch.
- k) Adjust VR7 to obtain the same center position when the display is magnified.
- l) Adjust of sweep linearity: Adjust VR10 so that sine wave could not be concentrated at one side under time 0.1mS/Div.
- m) Adjustment of triggering: Adjust VR5 so that both (Sync + or -) start at the same point.

2. ADJUSTMENT OF X-AXIS (CH-B) POSITION With SWEEP TIME/DIV. control set at CH-B, check if shift range is balanced when X-axis POSITION (CH-B VERTICAL POSITION) is turned. If there is unbalance, Adjust VR9 and then Adjust VR11 to be at the center of X-axis.
3. ADJUSTMENT OF TRACE LINE LENGTH Adjust VR13 to obtain the length of 11DIV on CRT screen.
4. ADJUST VR1 VR2 AND VR3 FOR CALIBRATION To be 0.5V P-P when 1:1 probe is connected to the terminal of front panel calibration under VOLT/DIV 0.1V and TIME/DIV 0.1ms
5. ADJUST TC5 FOR 0.5 sec LENGTH The length of trace line could be reached on the CRT surface when you input 0.5 μ S pulse under TIME/DIV 0.5 μ S range.
6. ADJUST TC4 FOR 0.5 sec /DIV MAG LINEARITY Same as 3 adjustment after you draw PULL 5 X MAG SWITCH
7. Adjust VR15 for jittering.
8. Adjust TC3 for unblinking start position.

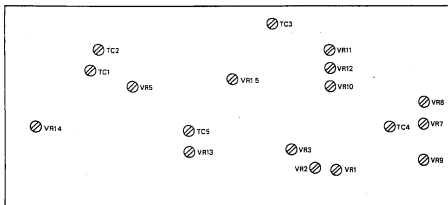

FOIL SIDE VIEW
CALIBRATION LOCATIONS FOR HORIZONTAL/TIME BASE UNIT
290-1004-14

SECTION 6

PARTS LIST

6-1 CHASSIS (700-1110-00)

REF. NO.	PARTS NO.	DESCRIPTION	
	100-1020-03	Case Top	
	100-1021-03	Case Bottom	
	118-1016-12	Ornamental Panel	
	150-1001-04	Side Eacutcheon	
	126-1008-02	Rear Panel	
	140-1033-03	Frame (A)	
	140-1034-03	Frame (B)	
	140-1035-03	Frame (C)	
	140-1036-03	Frame (D)	
	140-1037-03	Frame (E)	
	140-1038-03	Side Frame (right)	
	140-1039-03	Side Frame (left)	
	160-1014-04	P.T. Holder Plate	
	160-1015-03	CRT Holder	
	160-1013-04	VR Mounting Metal	
	160-1017-04	Metal Mount for Slide SW	
	200-1000-03	CAL Terminal	
		GND Terminal	
		Moulded Terminal	
	288-1000-05	AC Innet Ass'y	
	215-1000-05	CRT Socket	
	235-1000-04	Mould Bearing	
	255-1006-03	CRT Band (A)	
	255-1007-03	CRT Band (B)	
	260-1000-05	BNC Receptacle	
	330-1002-04	Shield Plate	
	330-1032-04	Shield Plate (A)	
	400-1002-05	Handle	
	405-1002-05	Rubber Leg	
	405-1004-03	Moulded Leg	
	405-1005-03	Stand	
	415-1002-03	Bezel	
	420-1017-04	Knob for T. Position, V. Position x 2, Iten, Focus, Trig Level	
	420-1030-04	Knob for T. Rotary SW	
	420-1012-04	Knob for T. Variable, V. Variable x 2	
	420-1029-04	Knob for AC-GND-DC x 2, Slope, Sync, Source, Mode	
	420-1018-04	Knob for Comp Test SW	
	420-1016-04	Knob for V. Rotary SW x 2	
	430-1000-04	CRT Screen Filter	
	002-1000-05	Potentiometer	1k Ω
	002-1001-05	"	20k Ω
	002-1017-05	"	2M Ω
	002-1007-05	"	1k Ω
	002-1012-05	"	50k Ω
	002-1016-05	"	50k Ω
	020-1006-05	Slide Switch	
	024-1004-05	Push Switch	
	026-1000-05	Toggle Switch	
	040-1007-05	Power Transformer	
	050-1003-05	Rotation Coil	
	080-1002-05	Fuse	1A
	080-1004-05	"	0.5A
		CRT	
		LED	
		LED Holder	

SECTION 6

PARTS LIST

6-2 VERTICAL AMPLIFIER UNIT (290-1016-34)

REF. NO.	PARTS NO.	DESCRIPTION		
S1,2	018-1005-05	Rotary Switch		
S3	022-1009-05	Lever Switch		
VR2,8	002-1004-05	Potentiometer	5k Ω	
IC1,2	HA1127G	Linear IC	(CA3046)	
IC5	SN74LS03N	IC (LSTTL)		
IC3	CD4001B	" (C2MOS)	(MC14001B)	
IC4	CD4011B	" (")	(MC14011B)	
Q2,26	2SK 228T	Dual FET		
Q1, 25	2SK30A (O)	"		
Q19, 20	2SA1144 (Y)	Transistor		
Q17, 18	2SC 2704 (Y)	"		
Q7, 8, 12, 13, 14, 31, 32	2SA836 (D)	"		
Q11, 15, 16, 23, 24, 33, 34	2SC458 (D or E)	"		
Q3, 4, 5, 6, 9, 10, 27, 28, 29, 30	2SC535 (B)	"		
Q21, 22	2SA781 (K)	"		
D1-9, 11, 15-24	1S1588	Diode		
D10, 14	HZ5C2	Zener Diode		
VR3, 5, 9, 11, 12	008-1004-05	Potentiometer	100 Ω B	
VR1, 7, 13	008-1006-05	"	1k Ω B	
VR6	008-1007-05	"	470k Ω B	
VR4, 10	008-1013-05	"	680 Ω B	
TC1, 3, 5, 7, 9, 11		Trimmer	4pF	
TC2, 4, 6, 8, 10, 12, 13		"	10pF	
R8, 112	RN14BK2H1004F	Metal Film Resistor	1M Ω	$\pm 1\%$ 1/2W
R6, 110	" 9993F	"	999k Ω	" "
R4, 108	" 9903F	"	990k Ω	" "
R2, 106	" 9003F	"	900k Ω	" "
R3, 107	RN14BK2E1113F	"	111k Ω	" 1/4W
R78, 82	" 1003F	"	100k Ω	" "
R80	" 4302F	"	43k Ω	" "
R36, 37, 139, 140	" 1202F	"	12k Ω	" "
R5, 109	" 1012F	"	10.1k Ω	" "
R21, 22, 125, 126	" 8201F	"	8.2k Ω	" "
R12, 13, 116, 117	" 6801F	"	6.8k Ω	" "
R64, 66, 71	" 4701F	"	4.7k Ω	" "
R63	" 3301F	"	3.3k Ω	" "
R44, 45, 149, 150	" 3001F	"	3k Ω	" "
R85, 93	" 2201F	"	2.2k Ω	" "
R32, 136	RN14BK2E1501F	Metal Film Resistor	1.5k Ω	$\pm 1\%$ 1/4W
R7, 23, 57, 60, 111, 127	" 1001F	"	1k Ω	" "
R24, 129	" 8200F	"	8.2k Ω	" "
R39, 40, 142, 143	" 6800F	"	6.8k Ω	" "
R29, 31, 133, 135	" 4700F	"	4.7k Ω	" "
R35, 138	" 3300F	"	3.3k Ω	" "
R26, 131	" 2200F	"	2.2k Ω	" "
R46, 153	" 82ROF	"	82 Ω	" "
C10, 12, 48	CE04W1C220RC2	Electrolytic Capacitor	22 μ F	16VV
C7, 18, 22, 45, 49, 59, 63	" 1H4R7RC2	"	4.7 μ F	50VV
C15, 16, 17, 20, 25	" 1H1RORC2	"	1 μ F	
C6, 24, 44, 62	DD600BC104Z12V	Ceramic Capacitor	0.1 μ F	12VV
C27, 32	CQ92MH103K	Mylar Capacitor	0.01 μ F	$\pm 10\%$ 50VV
C26, 31, 33, 34, 38	CK45E2H103P	Ceramic	0.01 μ F	500VV
C60	" 1H103P	"	0.01 μ F	50VV

REF. NO	PARTS NO	DESCRIPTION			
C5, 43		Metal Film Capacitor	0.01 μ F	+10%	600WV
C4, 42	CM93D1H152J	Myca Capacitor	1500pF	+5%	50WV
C2, 40	" 221J	"	220pF	"	"
C1, 39	" 330J	"	33pF	"	"
C29, 65, 67	CC45CH1H101J	Ceramic Capacitor	100pF	"	"
C61, 36	" 560J	"	56pF	"	"
C55, 57, 64	" 470J	"	47pF	"	"
C9, 13, 19, 47, 52	" 220J	"	22pF	"	"
C35	" 200J	"	20pF	"	"
C21	" 150J	"	15pF	"	"
C8, 46, 11, 50	" 5ROD	"	5pF	"	"
C3, 41	CC45CH2H2ROD	"	2pF	"	500WV
C23, 28	" 1ROD	"	1pF	"	"
C66, 68	CC45CH1H180J	"	18pF	"	50WV
L7, 8		Ferri Inductor	470 μ H		
L1, 2, 3, 4		"	47 μ H		
L5, 6		"	1 μ H		

6-3 TIME BASE UNIT (290-1020-43)

L2		Ferri Inductor			
L3		"			
L1		"			
IC6	μ A733DC	IC (VIDEO AMP)			
IC1	SN74LS00	IC (LSTTL)			
IC5	SN74LS76	IC (")			
IC2	SN7400	IC (TTL)			
IC3, 4	MC14572UB	IC (C2MOS)			
Q8	2SK30A (O)	FET			
Q4, 7, 10, 11, 12, 13, 14, 15	2SA836	Transistor			
Q16, 22, 24	"	"			
Q1, 2, 3, 6, 9, 17, 18, 21, 23	2SC458 (D)	"			
Q15, 16, 25, 26	"	"			
Q19, 20	2SC 2704	"			
D4	IN60	Diode			
D5, 10	IS1587	"		(IS2076A)	
D1, 2, 3, 6, 7, 8, 9, 13, 14, 15	IS1588	"		(IS2076)	
D16, 17, 18, 20	"	"		"	
D11, 12	HZ5C2	Zener Diode			
D19	HZ12C2	"			
VR4, S5	002-1005-05	Potentiometer	20k Ω		
VR6	002-1006-05	"	10k Ω		
S4	018-1008-05	Rotary Switch			
S1	022-1011-05	Lever Switch			
S2	022-1010-05	"			
S3	022-1009-05	"			
VR13, 14	008-1017-05	Potentiometer	100k Ω		
VR1, 2, 5, 7, 8	008-1018-05	"	50k Ω		
VR9	008-1019-05	"	20k Ω		
VR3	008-1020-05	"	5k Ω		
VR11	008-1021-05	"	200 Ω		
VR10	008-1025-05	"	1k Ω		
VR12	008-1026-05	"	500k Ω		
VR15	008-1023-05	"	10k Ω		
R48	RKS1/4P3MF	Metal Film Resistor	3M Ω	1/4W	\pm 1%
R39, 42, 44	RN14BK2E1003F	"	100k Ω	"	"

REF. NO.	PARTS NO.	DESCRIPTION			
R45	" 2E3003F9	"	300kΩ	"	"
R46	" 2H5003F	"	500kΩ	1/2W	"
R47	" 2H1004F	"	1MΩ	"	"
R94, 95	RS14AD3F682G	"	6.8kΩ	3W	±2%
TC1, 2, 3, 4, 5		Trimmer	10pF		
C19		Metal Film Capacitor	0.47μF	200WV	
C20		"	0.0047μF		
C5, 15, 23, 30, 31, 33, 45, 13	DD600BC104Z12V	Ceramic Capacitor	0.1μF	12WV	
C51, 52, 53	CEO4W1A331	Electrolytic Capacitor	330μF	10WV	
C50	" 1C221	"	220μF	16WV	
C8	" 1A470	"	47μF	10WV	
C47, 48, 49	" 1C220RC2	"	22μF	16WV	
C41	" 2E4R7	"	4.7μF	250WV	
C7, 12, 14, 29, 34	" 1H1RORC2	"	1μF	50WV	
C40	CK45E2H103P	Ceramic	0.01μF	500WV	
C4, 18, 35	" 1H103P	"	0.01μF	50WV	
C24, 25	" 1H561M	"	560pF	"	
C37, 38	" 1H471M	"	470pF	"	
C26, 42	CC45CH1H221J	"	220pF	"	
C28, 43	" 151J	"	150pF	"	
C39	" 680J	"	68pF	"	
C1, 17, 27	" 470J	"	47pF	"	
C21	" 390J	"	39pF	"	
C10	" 221J	"	220pF	"	
C22	" 150J	"	15pF	"	
C44	" 120J	"	12pF	"	
C11, 16	" 100J	"	10pF	"	
C3	" 2H5ROD	"	5pF	500WV	
C32	" 2H1ROD	"	1pF	"	
C6	CQ92M1H104K	Mylar Capacitor	0.1μF	50WV	
C46	" 1H223K	"	0.022μF	"	
C2	" 1H472K	"	4700pF	"	
C9	" 1H222K	"	2200pF	"	
C36	" 1H102K	"	1000pF	"	

6-4 POWER SUPPLY UNIT (290-1017-33)

F1	080-1003-05	Mini Fuse	0.5A
	225-1000-05	Fuse Holder	
	040-1008-05	Converter Transformer	
L1		Inductor Coil	470μH
L2		"	4.7μH
VR3, 4	008-1022-05	Potentiometer	1MΩ
VR5	008-1017-05	"	100kΩ
VR1	008-1018-05	"	50kΩ
VR2	008-1023-05	"	10kΩ
VR6	008-1024-05	"	2kΩ
NI, 2, 3, 4	NE38B	Neon Lamp	
IC1	μA741TC	IC	
IC2	μA8912	"	
IC3	μA7805	"	
IC4	μA7908	"	
IC5	μA78L15	"	
Q3, 6, 11	2SA836	Transistor	
Q1	2SD596 (D)	"	
Q2, 5, 10	2SC458 (D)	"	
Q8, 9, 12	2SC1885	"	
Q4	2SD401 (K)	"	

SECTION 6

PARTS LIST

REF. NO.	PARTS NO.	DESCRIPTION			
D1, 2, 3	2W02	Diode			
D6, 18	Y16GA	"			
D4, 12, 13	1S1588	"	(1S2076)		
D15, 16	V06C	"			
D7, 8, 9, 10	1SS83	"			
D11, 17	HZ5C2	Zener Diode			
D14	HZ4B3	"			
S1	SDT 1000	Thermister		10k Ω	
(Ordinary carbon resistors are not listed.)					
R6	RN14BK2E4701F	Metal Film Resistor	4.7k Ω	1/4W	\pm 1%
R5	RN14BK2E1203F	"	120k Ω	"	"
R10	RN14BK2E3901	"	3.9k Ω	"	"
C31	CQ92M1H104K	Mylar Capacitor	0.01 μ F	50WV	
C14	" 473K	"	0.047 μ F	"	
C39	" 472K	"	0.47 μ F	"	
C43	" 222K	"	0.22 μ F	"	
C28	DD600BC104Z12V	Ceramic Capacitor	0.1 μ F	12WV	
C30	CC45SL2H1ROD	Ceramic	1pF	500WV	
C18, 19, 30, 21, 23, 25, 38	CK45E3D103P	"	0.01 μ F	2000WV	
C22, 27, 29, 32	" 2H103P	"	"	500WV	
C16	" 1H103P	"	"	50WV	
C34	" 2H102P	"	1000pF	500WV	
C35	" 1H681M	"	680pF	50WV	
C7, 10, 42	CE04W1E222	Electrolitic Capacitor	2200 μ F	25WV	
C8	" 1E471	"	470 μ F	25WV	
C37	" 1H221	"	220 μ F	50WV	
C1,4	" 2C101	"	10 μ F	160WV	
C36	" 1E331	"	330 μ F	25WV	
C3,40	" 2E330	"	33 μ F	250WV	
C5, 6	" 2E100	"	10 μ F	250WV	
C9, 13, 17, 41	" 1H1RORC2	"	1 μ F	50WV	
C24	" 2E1RO	"	1 μ F	250WV	
	330-1030-03	Shield Case for DC-DC			

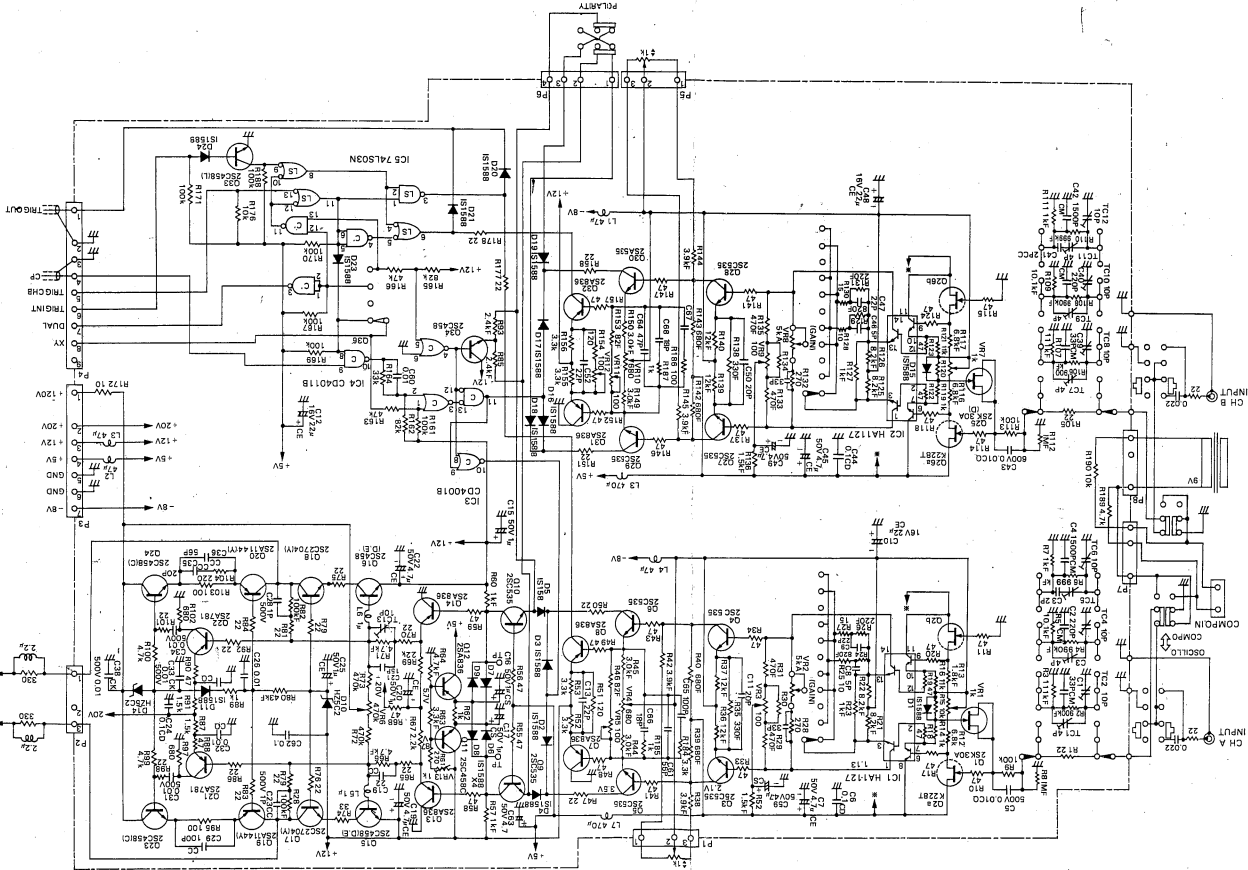

7-1(1) VERTICAL AMP CIRCUIT DIAGRAM

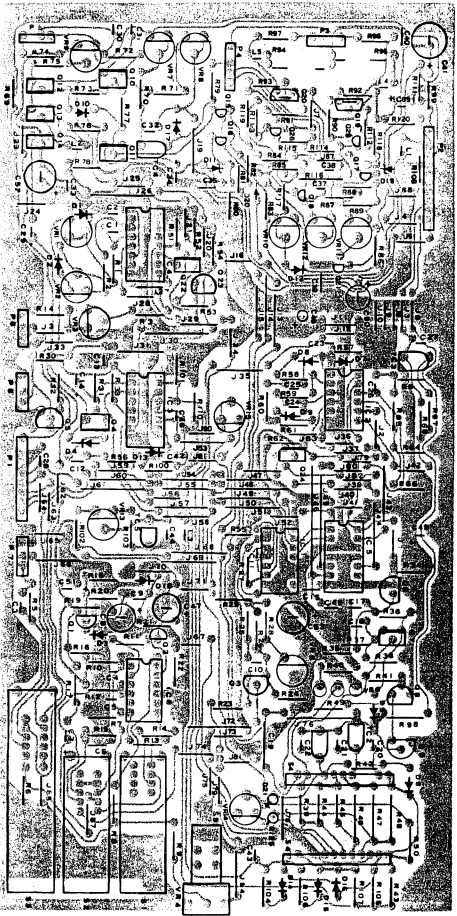

7-2 HORIZONTAL/TIME BASE UNIT

7-2-(1) HORIZONTAL/TIME BASE CIRCUIT DIAGRAM
(290-1020-43)

